

Katun Products for use in  
**Nashuatec**

Table of Contents

	<i>Page</i>
<b>Copy Machine Equivalency List</b> .....	i
<b>Descriptions of Katun Product Brands and Technologies</b> .....	ix
<b>Beschreibungen der Produktmarken und Technologien von Katun</b> .....	xi
<b>Personalized Product Agreement</b> .....	xiii
<b>Vereinbarung Über Bestellung Von Produkten Mit Ihrem Firmenetikett</b> .....	xv
<b>Bearings/Bushings</b> .....	1
<b>Belts</b> .....	6
<b>Blades/Brushes</b> .....	7
<b>Corona/Charge/Transfer</b> .....	10
<b>Developers</b> .....	14
<b>Feed/Delivery</b> .....	15
<b>Filters</b> .....	22
<b>Fuser Cleaning</b> .....	23
<b>Fuser Oil</b> .....	25
<b>Gears</b> .....	26
<b>Kits</b> .....	27
<b>Lamps</b> .....	31
<b>Memory Upgrades</b> .....	32
<b>Miscellaneous</b> .....	33
<b>Photoreceptors</b> .....	34
<b>Picker Fingers</b> .....	38
<b>Rollers, Fuser/Heat</b> .....	40
<b>Rollers, Pressure</b> .....	44
<b>Seals</b> .....	47
<b>Springs</b> .....	48
<b>Thermal Control Devices</b> .....	49
<b>Toners/Toner Cartridges</b> .....	50
<b>General Information</b> .....	I
<b>Allgemeine Hinweise</b> .....	III
<b>Distributor Choice Warranty Claim Form</b> .....	V
<b>HÄNDLER-GARANTIEFORMULAR</b> .....	VII



## Copy Machine Equivalency List

Central/Eastern Europe  
 Telephone: 31(0)183-696969  
 Fax: 31(0)183-629055  
 E-mail: order@edc.katun.com

Nashuatec	Danka Infotec	Gestetner	Rex Rotary	Ricoh
1205	8012			
1210	1401			
1215	1402			
1218	8018			
1220	1101			
1220 -DF	1201			
1230	1701			
1230 -DF	1801			
1240	1301			
1240 -S	1320			
1250	1501			
1260	1601			
1280	8036			
1280 -DF	8036 F			
1290	8036 R			
1290 -DF	8036 RF			
1505		1502	1508	AFICIO 1015
1805		1802	1808	AFICIO 1018
1805 D		1802 d	1808 D	AFICIO 1018 D
2208	9208	2508	8508 (OLD)	M 50
2304	5041	2404	8104	
2310		2410 Z	8110 Z	
2407	9407	2607	8607	M 60
2705		2712	2738	AFICIO 1027
3018	9118 Z	2518 Z	8518 Z	FT 4418
3035				FT 5540
3114		2301	8014	
3114 L		2302 Z	8114 Z	
3115	9215	2515 Z	8515 Z	FT 4415
3118		2318 Z	8118 Z	
3120	9122 Z	2520 ZD		FT 4421
		2522		
3133	9233 Z	2533 z	8533	FT 5233
3133 L		2533 lz		FT 5433
3133 LD	9233 DZ	2533 lzd	8533 D	FT 5733
3135 D				FT 5540
3213	9213 Z	2513 Z	8513 Z	FT 3313
3213 L		2513 LZ		FT 3413
3213 S	9213	2513	8513	FT 3113
3222	9122 Z	2520 ZD		FT 4421
		2522		
3227		2527 Z	8527	FT 4227
3227 L	9227 Z	2527 LZ		FT 4427
3227 LD	9227 DZ	2527 ZD	8527 D	FT 4727
3310		2510 z	8210 Z	
3320	9320	2620	8520	FT 4220
3322	9322	2622	8522	FT 4222
3322 S	9222 Z	2622 s	8522 S	FT 4422
3412		2312 Z	8212 Z	
3413	9313 Z	2613 z	8613 Z	FT 3213
3413 S	9313	2613	8613	FT 3013
3415	9315	2615	8615	FT 4215
3417		2417	8017 Z	

## Copy Machine Equivalency List

Nashuatec	Danka Infotec	Gestetner	Rex Rotary	Ricoh
3512		2412 Z	8312 Z	
3515		2315	8015 Z	
3522	5221 Z	2822	8622 Z	FT 4022
3522 td	5221 DZ	2822 td	8622 DZ	FT 4522
3523		2423	8023 Z	
3525		3502	3508	AFICIO 1035
3527	5271 Z	2627	8627 Z	FT 4027
3527 t	5271 ZU	2627 t	8627 LZ	FT 4127
3527 td	5271 DZ	2627 td	8627 DZ	FT 4527
3530		2430	8230 Z	
3535	5351 Z	2635	8635 Z	FT 5035
3535 t	5351 ZL	2635 t	8635 LZ	FT 5135
3535 td	5351 DZ	2635 td	8635 DZ	FT 5535
3540		2440	8140 DZ	
3612	5121 Z	2812 z	8612 Z	FT 2212
3612 S	5121	2812	8612	FT 2012
3618		2418 Z	8018	
3632	5321 Z	2632	8632	FT 5632
3640	5403 Z	2740 z	8640	FT 5640
			8740 Z	
3708	5081 Z	2808 z	8708 Z	FT 1208
3708 S	5081	2808	8708	FT 1008
3713	5131 Z	2713 z	8713 Z	FT 3713
3713 S	5131	2713	8713	FT 3513
3715	5151 Z	2715 z	8715 z	FT 4015
3715 +	5152 Z	2715 z+	8715 Z+	FT 4615
3718	5181 Z	2718 z	8718 Z	FT 4018
3718 +	5182 Z	2718 z+	8718 Z+	FT 4618
3722	5222 Z	2722 z	8722 z	FT 4622
3722 td	5222 DZ	2722 ztd	8722 ztd	FT 4822
3732	5321 ZL	2732 z	8732 Z	FT 5732
3732 td	5321 DZ	2732 ztd	8732 ZTD	FT 5832
3740	5403 Z	2740 z	8640	FT 5640
			8740 Z	
3740 t	5403 ZT	2740 zt	8740 ZT	FT 5740
3740 td	5403 DZ	2740 ztd	8740 ZTD	FT 5840
3900	9012			M 10
3913	5132 Z	2913 Z	8913 Z	FT 3813
3913 S	3613	2913	8913	FT 3613
3916		2316	8016	
3916 D		2316 ZD	8316 DEZ	
3916 L		2316 TCE	8216 TCE	
3916 R		2316 Z	8116 Z	
3916 S		2315	8015 Z	
3943	9143 Z	2543 z	8543	FT 5550
3943 d	9143 DZ	2543 zd	8543 D	FT 5570
4050	9153 DZ	2553 zd	8553 D	FT 6750
4100	9015			FT 3020
4110	9015 RE			FT 3050
4115	9015 Z			FT 3060
4172	9172 DZ	2572 zdf		FT 7870
4280		2580 zdf	8580 DZF	FT 8780
4280 rdh	9280	2580 rdz	8580 DZH	FT 8880

## Copy Machine Equivalency List

Central/Eastern Europe  
 Telephone: 31(0)183-696969  
 Fax: 31(0)183-629055  
 E-mail: order@edc.katun.com

Nashuatec	Danka Infotec	Gestetner	Rex Rotary	Ricoh
4285		2485 ZDF	8085 DZF	
4300	9018			FT 4030
4310	9020			FT 4060
4325 z	9025 Z			FT 4085
4345	9345 DZ	2545 d	8545 DZ	FT 6645
4355	9355 DZ	2555 d	8555 DZ	FT 6655
4365	9365 DZ	2565 d	8565 DZ	FT 6665
4460		2460	8060 DZF	
4510 z	9035 Z			FT 5050
4525		4502	4508	AFICIO 1045
4550 z	9035 DZ			FT 5070
4580 rdh	5801 RDH	2680 rdh	8680 RDH	FT 8980
4582	5821 DZ	2682 d	8682 D	FT 8982
4592		2492	8092 ZDF	
4651	5501 DZ	2651	8651	FT 7650
4660	5601 DZ	2660	8660	FT 7660
		2760		
4670	5701 DZ	2670	8670	FT 7670
		2770		
4680		2480	8080	
4790 MK1	9046 RED			FT 6080
4790 MK2	9050 RED			FT 6085
4851	5502 DZ	2851	8851	FT 7950
4860	5602 DZ	2860	8860	FT 7960
4870	5702 DZ	2870	8870	FT 7970
4965	9165 DZ			FT 7770
5108	9208 OLD			M 5
5115	9016			FT 2050
5115 RE	9016 Z			FT 2070
5120	9020 Z			FT 4065
5130	9032 Z			FT 5010
5131	9032			FT 5000
5307		25A0	8007	FW 830
55A0		26A0	83A0	FW 740
57A0		27A0	87A0	FW 870
6115	9016 S			M 100
6160	9060 DZ			FT 7060
6905		LC A0	LC A0	
7112	9014			FT 3320
7120	9021 Z			FT 4460
7125	9026 Z			FT 4480
7125 II	9126 Z			FT 4490
7125 S	9125 Z	2525 Z		FT 4470
7130	9034 Z			FT 5520
	9134 Z			
7140	9040 Z			FT 5560
7150	9048 Z			FT 5580
	9150 Z			
7150 C	9052 DZ			FT 6620
7150 D	9048 DZ			FT 5590
	9150 DZ			
8108		GPC 1	8005	
8108 C		GPC 2	8008	

## Copy Machine Equivalency List

Nashuatec	Danka Infotec	Gestetner	Rex Rotary	Ricoh
8112		2201	8012 C	
8112 RE		2203 Z	8112 Z	
8115	9115 Z			FT 2260
8120		2320 Z	8020 TCE	
8122		2322 Z	8122 TCE	
8122 S		2222 Z	8022 Z	
37105		27105		FT 9105
481A0		281A0	881A0	FW 750
482A0		282A0	882A0	FW 760
53101	9101	25101	85101	FT 9101
C 240	7125	2730		NC 100
C 302	7130	2735	CC 8330	NC 305
C 315	7150	2780		NC 8015
C 406	7306	2706	CC 8406	NC 5006
C 503	7212 Z	2703	CC 8403	AFICIO COLOR 2003
C 503 D	7212 DZ	2703 d	CC 8403 D	AFICIO COLOR 2103
C 503 De	7212 EZ	2703 de	CC 8403 DE	AFICIO COLOR 2203
C 606	7316	2606	CC 8606	AFICIO COLOR 5106
C 606 E	7316 E	2606 e	CC 8606 E	AFICIO COLOR 5206
CS 506	7216 Z	CS 206	CS 806	AFICIO COLOR 3006
CS 506 d	7286 DZ	CS 206 D	CS 806 d	AFICIO COLOR 4006
CS 506 de	7286 EZ	CS 206 de	CS 806 DE	AFICIO COLOR 4106
CS 510	7410	CS 210	CS 810	AFICIO COLOR 6010
CS 510 E	7410 E	CS 210 e	CS 810 e	AFICIO COLOR 6110
CS 513 d		CS 213 d	CS 813 D	AFICIO COLOR 6513
CS 525		CS 225	CS 825	AFICIO COLOR 3506
CS 531		CS 231	CS 831	AFICIO COLOR 4506
D 209	5020			DS 320
D 415 S	4150 MF	3215 S	2815 S	AFICIO 150
D 418	4180 MF	3218	2818	AFICIO 180
D 420	4201 MF	3220	2820	AFICIO 200
D 422	4220 MF	3222	2822	AFICIO 220
D 425	4251 MF	3225	2825	AFICIO 250
D 427	4270 MF	3227	2827	AFICIO 270
D 431		3131		DS 5330
D 435	4352 MF	3235	2835	AFICIO 350
D 435 s	4351 MF	3235 S	2835 s	AFICIO 340
D 440	5402 MF	3240	2840	AFICIO 401
D 445	4451 MF	3245	2845	AFICIO 450
D 455	4550 MF	3255	2855	AFICIO 550
			8255 E	
D 465	4651 MF	3265	2865	AFICIO 650
D 485	4850 MF	3285	2885	AFICIO 850
D 555	4551 MF	3355	2955	AFICIO 551
D 570	4700 MF	3270	2870	AFICIO 700
		3370		
D 1205		1202	1208	AFICIO 120
D 1305		1302	1308	AFICIO 1013
D 1305 F		1302 f	1308 f	AFICIO 1013 F
D 2205		2212	2238	AFICIO 1022
D 2705		2712	2738	AFICIO 1027
D 3205		3212	3238	AFICIO 1032
D 3525		3502	3508	AFICIO 1035

## Copy Machine Equivalency List

Central/Eastern Europe  
 Telephone: 31(0)183-696969  
 Fax: 31(0)183-629055  
 E-mail: order@edc.katun.com

Nashuatec	Danka Infotec	Gestetner	Rex Rotary	Ricoh
D 3640	5401 DZ	2640 e	8240 e	AFICIO 400
D 4105	4105 MF	32105	28105	AFICIO 1050
D 4850		2850 e	8250 E	AFICIO 500
D 5505		5502		AFICIO 1055
D 6005		6002	6008	AFICIO 1060
D 7505		7502	7508	AFICIO 1075
D 8505		8502	8508	AFICIO 1085
D 10505		10502	10508	AFICIO 1105
DSc 38 +		DSc 38 +	DSc 38 +	AFICIO AP 3800 CMF
DSc 224		DSc 224		AFICIO 1224 C
		DSC 224 SP		AFICIO 1224 C S/P
DSc 232		DSc 232		AFICIO 1232 C
		DSC 232 SP		AFICIO 1232 C S/P
		DSC 532		
DSM 415				AFICIO 1515
DSM 415 F				AFICIO 1515 F
DSM 415 P				AFICIO 1515 PS
DSM 415 PF				AFICIO 1515 MF
DSM 615		DSM 615		AFICIO 2015
DSM 618		DSM 618		AFICIO 2018
DSM 618 D		DSM 618 D		AFICIO 2018 D
DSM 632				AFICIO 2032
AD- 52		AD- 52		
AD- 53		AD- 53	AD- 53	
ADF- 6		ADF- 6		
ADF- D 209	ARDF- 5020			DF- 53
ADF- M 5		ADF- M 5	ADF- M 5	
ARDF- 6160	ARDF- 9060 DZ	ARDF		ARDF
AS- M 5		AS- M 5	AS- M 5	
CB- 140	CB- 1/21			PS- 210
CB- 150	CB- 4	CB- 150	CB- 150	PS- 220
	CB- 3/48			
CB- 313 X1	CB- 33/1	CB- 313 X1	CB- 313 X1	PS- 140
CB- 313 X3	CB- 33/3	CB- 313 X3	CB- 313 X3	PS- 250
CCFPU- 6	FP- 7306	CCFPU- 6	CCFPU- 6	SPU- 2
CDX- 20	DU- 9320	CDX- 20		AD- 130
CFN- 55	STAPLER- III	CFN- 55	CFN- 55	SR- 400
CFN- 101		CFN- 101	CFN- 101	SR- 500
CLCT- 55	LCT- 5	RT- 31		RT- 31
CONTROLLER- 850		CONTROLLER- 850	CONTROLLER- 850	CONTROLLER- 850
CONTROLLER- 1013		CONTROLLER- 1013	CONTROLLER- 1013	CONTROLLER- 1013
CONTROLLER- 1018		CONTROLLER- 1018	CONTROLLER- 1018	CONTROLLER- 1018
CRDH- 55	DH- III	CRDH- 55	CRDH- 55	DH- 400
CRF- 55	ARDF- VII	CRF- 55	CRF- 55	DF- 60
CS- 130	CS- 130	CS- 130	CS- 130	CS- 130
CS- 160		CS- 160	CS- 160	CS- 160
CS- 220	CS- 220	CS- 220	CS- 220	CS- 220
CSS- 55	SS- 204	ST- 25	ST- 25	ST- 25
DF- 43	DF- 43	DF- 43	DF- 43	DF- 43
DF- 64	DF- 64	DF- 64	DF- 64	DF- 64
DF- 65	DF- 65	DF- 65	DF- 65	DF- 65
DF- 67	DF- 67	DF- 67	DF- 67	DF- 67
DF- 68		DF- 68	DF- 68	DF- 68

## Copy Machine Equivalency List

Nashuatec	Danka Infotec	Gestetner	Rex Rotary	Ricoh
DF- 69		DF- 69	DF- 69	DF- 69
DF- 70		DF- 70	DF- 70	DF- 70
DF- 71		DF- 71	DF- 71	DF- 71
DF- 72		DF- 72	DF- 72	DF- 72
DH- 4050	DH- II	DH- 4050	DH- 200	DH- 200
DIG LCT- 1		DIG LCT- 1	DIG LCT- 1	PS- 310
DIG LCT- D		DIG LCT- D	DIG LCT- D	PS- 320
DIG S- 1	S- 121	DIG S- 1		CS- 210
DU- 120	DUPLEX I- 21			AD- 500
DU- 140	DU II- 40			AD- 400
DU- 513	DU- 9032 Z			AD- 100
DU- 3018	DU- 9118	AD- 120	AD- 120	AD- 120
DU- 4050	DU- 5020			AD- 600
DU- 7130	DU- 9034	AD- 110	AD- 110	AD- 110
E- 310		E- 310	E- 310	E- 310
E- 700		E- 700	E- 700	E- 700
E- 710		E- 710	E- 710	E- 710
EB- 70		EB- 70	EB- 70	EB- 70
EB- 105		EB- 105	EB- 105	EB- 105
EU- C 302	CT- 2	EU- C 302	EU- C 302	PS- 150
F- 140	ADF- 9026 Z	DF- 38/39		DF- 38/39
F- 321	ADF- 1	F- 321	F- 321	DF- 40
F- 391		ADF- 4	ADF- 4	
F- 433	SADF- 9020 Z			DF- 11
F- 435	SADF- 9020			DF- 10
F- 456	ADF- 9035 DZ			DF- 32
F- 480	DF- 9050 RED			DF- 31
F- 511	ADF- 9016			DF- 36
F- 513	S/ADF- 9020 Z			DF- 34
F- 811	ARDF- IV	F- 811	F- 811	DF- 54
F- 812		ADF- 2	ADF- 2	
FIERY- 150 i	FIERY- 150 i	FIERY- 150 i		FIERY- 150 i
FIERY- 200 i	FIERY- 200 i	FIERY- 200 i	FIERY- 200 i	FIERY- 200 i
FIERY- E 300	FIERY-E 300	FIERY- E 300	FIERY- E 300	FIERY- E 300
FIERY- E 650	FIERY-E 650	FIERY- E 650	FIERY- E 650	FIERY- E 650
FIERY- XJ 80 e	FIERY-XJ 80 e	FIERY- XJ 80 e	FIERY- XJ 80 e	FIERY- XJ 80 e
FIERY- XJ 170 PLUS	FIERY-XJ 170 PLUS	FIERY- XJ 170 PLUS	FIERY- XJ 170 PLUS	FIERY- XJ 170 PLUS
FIERY- XJ 250 PLUS	FIERY-XJ 250 PLUS	FIERY- XJ 250 PLUS	FIERY- XJ 250 PLUS	FIERY- XJ 250 PLUS
FIERY- XJ 300 PLUS	FIERY-XJ 300 PLUS	FIERY- XJ 300 PLUS	FIERY- XJ 300 PLUS	FIERY-XJ 300 PLUS
FIERY- XJ 325 PLUS	FIERY-XJ 325 PLUS	FIERY- XJ 325 PLUS	FIERY- XJ 325 PLUS	FIERY- XJ 300 PLUS
				FIERY- XJ 325 PLUS
FIERY- XJ BP 100	FIERY-XJ BP 100	FIERY- XJ BP 100	FIERY- XJ BP 100	FIERY- XJ BP 100
FIERY- ZX 3200	FIERY-ZX 3200	FIERY- ZX 3200	FIERY- ZX 3200	FIERY- ZX 3200
FIERY- ZX 3300	FIERY-ZX 3300	FIERY- ZX 3300	FIERY- ZX 3300	FIERY- ZX 3300
FU- C 240	FFU- 7125	FU- 2730		TP FUSER- 1
IU- 251	INVERTER 9101	IU- 251		
LCT- 4965	LCT- 9165 DZ	RT- 25		RT- 25
MD- 6		MD- 6	MD- 6	
MD- 9		MD- 9	MD- 9	
MS SORTER- 20	S- 202	CS- 2080	CS- 2080	CS- 2080
	SORTER- 40/48			
PAPER BANK- D 209	PAPER BANK- 5020			PS- 110
PS- 270	PS- 270	PS- 270	PS- 270	PS- 270

## Copy Machine Equivalency List

Central/Eastern Europe  
 Telephone: 31(0)183-696969  
 Fax: 31(0)183-629055  
 E-mail: order@edc.katun.com

Nashuatec	Danka Infotec	Gestetner	Rex Rotary	Ricoh
PS- 280	PS- 280	PS- 280	PS- 280	PS- 280
PS- 290	PS- 290	PS- 290	PS- 290	PS- 290
PS- 330	PS- 330	PS- 330	PS- 330	PS- 330
PS- 360	PS- 360	PS- 360	PS- 360	PS- 360
PS- 380		PS- 380	PS- 380	PS- 380
PS- 390		PS- 390	PS- 390	PS- 390
PS- 400		PS- 400	PS- 400	PS- 400
PS- 410		PS- 410	PS- 410	PS- 410
PS- 420		PS- 420	PS- 420	PS- 420
PS- 440		PS- 440	PS- 440	PS- 440
PS- 450		PS- 450	PS- 450	PS- 450
PS- 460		PS- 460	PS- 460	PS- 460
PS- 480		PS- 480	PS- 480	PS- 480
PS- 490		PS- 490	PS- 490	PS- 490
PS- 500		PS- 500		PS- 500
RADF		RADF	RADF	
RADF- 3		RADF- 3	RADF- 3	
RADF- 4		RADF- 4	RADF- 4	
RADF- 5		RADF- 5	RADF- 5	
RADF- 6		RADF- 6	RADF- 6	
RF I- 120	ARDF I- 21			DF- 52
RF- 3	ARDF- V/VI	DF- 56	DF- 56	DF- 56
RF- II	ARDF- III	DF- 51	DF- 51	DF- 51
RF- 3020	ARDF- IV/II	RF- 3020	DF- 57	DF- 57
RT- 33	RT- 33	RT- 33	RT- 33	RT- 33
RT- 34	RT- 34	RT- 34	RT- 34	RT- 34
RT- 36	RT- 36	RT- 36	RT- 36	RT- 36
RT- 42		RT- 42	RT- 42	RT- 42
RT- 43		RT- 43	RT- 43	RT- 43
S- 313	S- 101	S- 313	S- 313	CS- 120
S- 391		AS- M 10	AS- M 10	
S- 430	SORTER- 9018			CS- 1020
S- 432	SORTER- 9025 Z			CS- 1030
S- 455	SORTER- 9035 DZ			CS- 1510
S- 479	SORTER- 9046 RED			CS- 2030
S- 511	SORTER- 9016			CS- 1040
S- 616	SORTER- 9060			CS- 2060
S- 812		AS- 7	AS- 7	
SADF- 4200	SADF- 9030			SADF
SK- 1		SK- 1	SK- 1	
SORTER- 4172	SORTER- 9165	CS- 2065		CS- 2065
SORTER- 7150 D	SORTER- 9048 DZ	CS- 1530	CS- 1530	CS- 1530
SORTER- D 209	SORTER- 5020			CS- 1070
SP- 4050	STAPLER- II	SR- 200	SR- 200	SR- 200
SPU- 4		SPU- 4	SPU- 4	SPU- 4
SR- 85		SR- 85	SR- 85	SR- 85
SR- 313	SS- 201	ST- 22	ST- 22	ST- 22
SR- 700		SR- 700	SR- 700	SR- 700
SR- 710		SR- 710	SR- 710	SR- 710
SR- 720	SR- 720	SR- 720	SR- 720	SR- 720
SR- 760		SR- 760	SR- 760	SR- 760
SR- 770		SR- 770	SR- 770	SR- 770
SR- 790		SR- 790	SR- 790	SR- 790

## Copy Machine Equivalency List

Nashuatec	Danka Infotec	Gestetner	Rex Rotary	Ricoh
SR- 800	SR- 800	SR- 800	SR- 800	SR- 800
SR- 810		SR- 810	SR- 810	SR- 810
SR- 820		SR- 820	SR- 820	SR- 820
SR- 840		SR- 840	SR- 840	SR- 840
SR- 850		SR- 850	SR- 850	SR- 850
SR- 860		SR- 860	SR- 860	SR- 860
SR- 3018	S- 102	SR- 3018	CS- 110	CS- 110
SR- 3227	SS- 203	ST- 24	ST- 24	ST- 24
SR- 4050	SS- 202	ST- 21	ST- 21	ST- 21
SR- 4965	SORTER/STAPLER- 9165	ST- 20		ST- 20
SS- 428 A		ST- 23 A	ST- 23 A	ST- 23 A
SS- 428 B		ST- 23 B	ST- 23 B	ST- 23 B
ST- 5		ST- 5		
ST- 6		ST- 6	ST- 6	
ST- 7		ST- 7	ST- 7	
ST- 10	ST- 10	ST- 10	ST- 10	ST- 10
ST- 27 A	ST- 27 A	ST- 27 A	ST- 27 A	ST- 27 A
ST- 27 B	ST- 27 B	ST- 27 B	ST- 27 B	ST- 27 B
ST- 29	ST- 29	ST- 29	ST- 29	ST- 29
ST- 32		ST- 32	ST- 32	ST- 32
ST- 33		ST- 33	ST- 33	ST- 33
ST- 428	FINISHER- 1	ST- 428	ST- 428	SR- 300
STP- 715	STAPLER- I	SR- 100	SR- 100	SR- 100
T- 1	LCT- 5020 LCT- 21/26	RT- 15	RT- 15	RT- 15
T- 45	LCT- 35/48	RT- 16	RT- 16	RT- 16
T- 51	LCT- 9032			RT- 14
T- 150	LCT- 48	RT- 21	RT- 21	RT- 21
T- 251		T- 251	T- 251	RT- 32
T- 428	LCT- 4	T- 428	T- 428	RT- 30
T- 812		ST- 4	ST- 4	
TC- 302	LCT - 3	TC- 302	TC- 302	RT- 17
TR- 85		TR- 85	TR- 85	TR- 85
TRAY KIT- 850		TRAY KIT- 850	TRAY KIT- 850	TRAY KIT- 850
UDH		UDH	UDH	

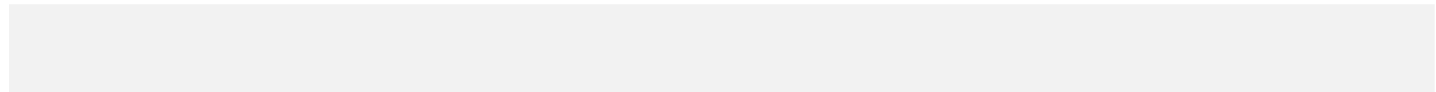
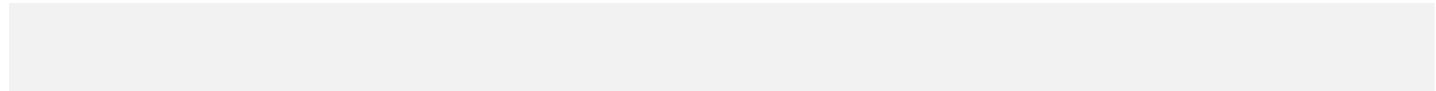

## Descriptions of Katun Product Brands and Technologies

### Katun Performance Products

Katun Performance is our complete line of office automation products that combine our highest quality level with consistent, reliable performance and competitive pricing - and provide excellent overall value.

Katun Performance products meet strict quality guidelines and have been 100% tested and approved according to the Katun 360° Certification process, which includes environmental testing, forward and reverse compatibility testing, model application testing, and component compatibility testing. In addition, all Katun Performance products are warranted to be free from functional defects in material and workmanship for one year and come with the highest level of Katun technical support.

To locate Katun Performance products, look for the Katun Performance icon  throughout this catalog.

### Access by Katun Products

Access by Katun is a line of selected products that address the unique pricing or product needs of specific markets. Access by Katun products provide market acceptable quality and market competitive pricing. The Access by Katun product line complements the Katun Performance line by providing a value proposition based primarily on specific market needs.

Access by Katun products come with a limited level of product support and a one-year warranty. Although Access by Katun products provide some price advantages, remember that Katun Performance products always provide excellent overall value.

### Original Products

Select OEM brand products that Katun offers to meet certain market needs

### Fuser Roller Coating Technologies

Minco Manufacturing, Inc., a wholly owned subsidiary of Katun Corporation, is a world-leading manufacturer of fuser rollers for use in plain paper copiers, facsimiles, and printers. The product development relationship between Katun, Minco, and DuPont, the exclusive manufacturer of genuine TEFLON<sup>®</sup> brand coatings, has produced numerous advanced fuser roller coating technologies, including:

**DURAPREM<sup>™</sup> II upper fuser rollers** are manufactured with a heat-resistant, nonstick TEFLON<sup>®</sup> brand coating that provides increased surface hardness for extended potential life. A proprietary finishing process produces an exceptionally smooth surface, which contributes to these rollers' excellent fusing performance and toner release in machines using negative-charge toner.

**DURACON<sup>™</sup> II upper fuser rollers** are manufactured with a heat-resistant, nonstick TEFLON<sup>®</sup> brand coating that includes patented conductive additives for static dissipation. These rollers provide excellent fusing performance, toner release, and long life, primarily in machines using positive-charge toner.

**ALUMANA<sup>™</sup> upper fuser rollers** are manufactured with extremely hard, tough primer and midcoat layers for maximum resistance to wear and abrasion. The ceramic ALUMANA coating combines a DuPont-patented polymer blend with reinforcing oxides for enhanced durability. These heavy-duty rollers are specifically designed to meet the demands of hostile fuser station environments and higher-speed machines using either positive-charge or negative-charge toner.

**TRITON<sup>™</sup> II upper fuser rollers** are manufactured with an advanced TEFLON<sup>®</sup> brand coating that provides improved fusing performance and nonstick characteristics in comparison to conventional fluoropolymer coatings. Unique static-dissipative particulates within the TRITON II coating, together with enhanced manufacturing processes, contribute to these rollers' superior abrasion-resistance and excellent toner release. These rollers provide extended potential life in selected machines using either positive-charge or negative-charge toner.

## Central/Eastern Europe

Telephone: 31(0)183-696969

Fax: 31(0)183-629055

E-mail: [order@edc.katun.com](mailto:order@edc.katun.com)

**TRITON BLUE™ upper fuser rollers** deliver excellent performance for machine applications that are tough on fuser rollers. Manufactured with an advanced TEFLON® brand coating that provides improved fusing performance and nonstick characteristics in comparison to conventional fluoropolymer coatings, TRITON BLUE™ fuser rollers combine improved wear resistance with superior abrasion-resistance and excellent toner release.

**TUF/SIL™ upper fuser rollers** are manufactured with a layer of silicone rubber that effectively regulates heat flow to the toner, plus an outermost layer that consists of a specially blended TEFLON® brand coating providing excellent toner release and abrasion-resistance. This combination ensures reduced toner offsetting and improved, more consistent copy quality under certain demanding machine usage conditions. These rollers provide a high-performance, cost-effective solution for selected machines required to consistently produce the best possible copy quality.

**MICROSLEEVE™ lower pressure rollers**, with nonstick PFA sleeves 50, 70, or 100 microns in thickness, provide excellent wear-resistance for improved copy quality over an extended life. A-Series MICROSLEEVE™ lower pressure rollers are designed specifically for machines utilizing lower fuser cleaning rollers. Their unique surface texture reduces toner buildup and improves cleaning efficiency within the fuser station.

All Katun fuser rollers are designed specifically for their intended applications and manufactured to exacting quality standards, ensuring their excellent performance and long life.

## Fuser Cleaning Roller Coating Technologies

Katun has introduced unique fuser cleaning roller technologies for machines requiring efficient removal and absorption of excess toner and contaminants, as well as continuous silicone oil lubrication of critical fuser station parts. For many machines, the ideal parts combination for achieving optimum copy quality and maximum parts life includes a specially designed Katun fuser cleaning roller.

**FIBRA™ fuser cleaning rollers** incorporate a uniform network of special fibers that aggressively remove excess toner and contaminants from the contacted surface. By efficiently depositing toner and contaminants beneath its outermost surface, the unique FIBRA network also helps maintain a continuous lubricative flow of silicone oil from the roller's internal tank to critical fuser station parts.

**FIBRA™ II fuser cleaning rollers** incorporate a unique configuration of highly heat-resistant fibers to greatly enhance cleaning performance, especially in hostile fuser station environments. Efficient absorption of excess toner and contaminants, together with continuous silicone oil lubrication of critical fuser station parts, effectively reduce parts and service expenses associated with the fuser station.

TEFLON® is a registered trademark of E.I. DuPont de Nemours and Company used under license by Katun Corporation.

## Personalized Product Program

Katun offers an extremely cost-effective way for office equipment dealers/distributors to ensure repeat business and strengthen relations with customers. The **Personalized Product program** enables dealers/distributors to provide high-quality Katun Performance imaging supplies (toner, fax and printer toner cartridges, digital duplicator inks and masters and thermal transfer ribbons) with their business name and /or logo, plus contact information, so end-users always know whom to call to reorder. For a one-time, nominal set-up fee, Katun designs and produces full-color labels to customer specifications and applies them to packaging at no extra charge. Only end-user-replaceable Katun Performance products are eligible under the program. Enrollment is simple and easy. Just complete the agreement form and submit it to your Katun sales representative or visit the Personalized Products page for more program and enrollment information.

## **Beschreibungen der Produktmarken und Technologien von Katun**

### **Katun Performance-Produkte**

Katun Performance ist unsere umfangreiche Produktreihe von Büromaschinenprodukten, die sich durch hohe Qualität sowie durch beständige, zuverlässige Leistung und attraktive Preise auszeichnen. Mit diesen Produkten soll der Nutzwert für den Kunden maximiert werden.

Katun Performance -Produkte erfüllen strenge Qualitätsstandards und wurden alle im Rahmen des 360° -Zertifizierungsverfahrens von Katun getestet und freigegeben. Die Produkte durchlaufen dabei Prüfungen der Umweltverträglichkeit, der Kompatibilität, der Modellanwendungen und der Komponentenkompatibilität. Darüber hinaus wird bei allen Katun Performance-Produkten ein Jahr lang gewährleistet, dass diese frei von funktionalen Material- und Verarbeitungsfehlern sind. Selbstverständlich steht Ihnen auch der hochwertige technische Support von Katun zur Verfügung.

**Um die Katun Performance-Produkte zu finden, halten Sie in diesem Katalog nach dem Namen Performance  und dem entsprechenden Symbol Ausschau.**

### **Originalprodukte**

Sie können verschiedene OEM-Produkte auswählen, die Katun aufgrund der Nachfrage auf dem Markt in sein Produktangebot aufgenommen hat.

### **Beschichtungstechnologien für Heizwalzen**

Minco Manufacturing Incorporated, eine hundertprozentige Tochtergesellschaft der Katun Corporation, ist einer der weltweit führenden Hersteller von Heizwalzen für Kopierer, Faxgeräte und Drucker. Die enge Zusammenarbeit zwischen Katun, Minco und DuPont, dem alleinigen Hersteller originaler TEFLON® - Beschichtungen, hat zur Entwicklung von zahlreichen neuartigen Beschichtungsmaterialien für Heizwalzen geführt:

**DURAPREM™II** Heizwalzen sind mit einer temperaturbeständigen TEFLON® - Antihaft-Beschichtung ausgestattet und besitzen daher eine größere Oberflächenhärte für eine potenziell längere Lebensdauer. Die nach einem speziellen Finish-Verfahren hergestellte, außerordentlich glatte Walzenoberfläche bietet hervorragende Fixier- und Antihaft-Eigenschaften in Geräten mit negativ geladenem Toner.

**DURACON™II** Heizwalzen sind mit einer temperaturbeständigen TEFLON® - Antihaft-Beschichtung ausgestattet, der patentierte, elektrisch leitfähige Inhaltsstoffe beigemischt sind, um das Ableiten von sich bildender statischer Ladung zu ermöglichen. Diese Heizwalzen zeichnen sich durch ihre hervorragenden Fixier- und Antihaft-Eigenschaften sowie eine lange Nutzungsdauer aus, besonders in Geräten mit positiv geladenem Toner.

**ALUMANA™** Heizwalzen besitzen eine äußerst harte, widerstandsfähige Grund- und Zwischenschicht für eine höchstmögliche Verschleißfestigkeit und Haltbarkeit. Die ALUMANA Keramiksicht beinhaltet eine patentierte Polymer-Mischung von DuPont mit Verstärkungsoxiden für eine erhöhte Widerstandsfähigkeit.

Diese robusten Heizwalzen sind speziell für anspruchsvolle Betriebsbedingungen in der Fixierstation und für schnellere Kopierer mit positiv oder negativ geladenem Toner konstruiert.

**TRITON™II Heizwalzen** zeichnen sich durch ihre hochwertige TEFLON® -Beschichtung aus, die herkömmlichen Fluorpolymer-Beschichtungen in Bezug auf Fixier- und Antihaft-Eigenschaften überlegen ist. Spezielle antistatisch wirkende Partikel in der TRITON II-Beschichtung und hohe Fertigungsstandards tragen zu den ausgezeichneten Antihaft-Eigenschaften und der hervorragenden Verschleißfestigkeit dieser Heizwalzen bei.

Sie bieten potentiell längere Laufzeiten in ausgewählten Geräten sowohl mit positiv als auch mit negativ geladenem Toner.

## Central/Eastern Europe

Telephone: 31(0)183-696969

Fax: 31(0)183-629055

E-mail: [order@edc.katun.com](mailto:order@edc.katun.com)

**TUF/SIL™ Heizwalzen** besitzen eine Silikonbeschichtung, die für eine effiziente regulierte Wärmeableitung an den Toner sorgt, sowie eine besonders zusammengesetzte TEFLON® - Beschichtung mit ausgezeichneten Antihaft-Eigenschaften und hoher Verschleißfestigkeit. Dies führt zu weniger Toner-Offsetting-Problemen und gewährleistet auch unter anspruchsvollen Betriebsbedingungen eine gleichbleibend hohe Kopienqualität. Die TEFLON®/SILIKON Heizwalzen bieten ein sehr gutes Preis-/Leistungsverhältnis für ausgewählte Geräte, die höchste Qualitätsansprüche in Bezug auf die Kopienqualität stellen.

**MICROSLEEVE™** Presswalzen mit Antihaft-PFA-Ummantelung in den Stärken 50, 70 und 100 µm bieten eine außergewöhnliche Haltbarkeit und damit eine langfristig bessere Kopienqualität und längere Nutzungsdauer. Die Presswalzen der MICROSLEEVE™ A-Serie sind speziell für den Einsatz in Geräten gedacht, bei denen eine Reinigung der unteren Presswalze mittels Reinigungswalze stattfindet.

Ihre besondere Oberflächenstruktur reduziert Tonerablagerungen und verbessert die Reinigungswirkung in der Fixierstation.

Alle Heizwalzen von Katun wurden speziell im Hinblick auf deren Einsatzzweck entwickelt und erfüllen höchste Qualitätsstandards. Nicht umsonst zeichnen sie sich durch eine herausragende Leistung und eine lange Nutzungsdauer aus.

## Beschichtungstechnologien für Reinigungswalzen

Katun hat spezielle Reinigungswalzen für Geräte entwickelt, die eine wirksame Beseitigung von Tonerresten und Schmutz sowie eine kontinuierliche Versorgung wichtiger Teile der Fixierstation mit Silikonöl erfordern. Durch den Einsatz einer Katun Reinigungswalze kann bei vielen Geräten eine optimale Kopienqualität und eine größtmögliche Nutzungsdauer der Komponenten erzielt werden.

**FIBRA™** Reinigungswalzen entfernen Tonerreste und Schmutzpartikel durch ein spezielles Fasernetz effizient von der Walzenoberfläche. Während das FIBRA-Fasernetz die Verschmutzungen wirkungsvoll in seiner Oberfläche aufnimmt, sorgt es zugleich für eine Dauerversorgung wichtiger Teile der Fixierstation mit Silikonöl aus dem Vorratstank im Walzeninneren.

**FIBRA™II** Reinigungswalzen besitzen ein neuartiges, hitzebeständiges Fasernetz, mit denen besonders unter anspruchsvollen Betriebsbedingungen eine erheblich verbesserte Reinigungswirkung erzielt wird.

Durch die wirksame Aufnahme von Tonerresten und Schmutzstoffen bei gleichzeitiger Dauerversorgung wichtiger Teile in der Fixierstation mit Silikonöl können die Austausch- und Servicekosten für die Fixierstation erheblich gesenkt werden.

TEFLON® ist ein eingetragenes Warenzeichen von E.I. DuPont de Nemours and Company und wird von der Katun Corporation unter Lizenz verwendet.

## Firmenetiketten-Programm

Katun bietet Händlern einen äußerst kostengünstigen Weg, ihre Kunden an sich zu binden und Kundenbeziehungen zu verbessern. Das **Firmenetiketten-Programm** erlaubt es Händlern, qualitativ hochwertige Verbrauchsmaterialien von Katun Performance (Toner, Drucker-/Faxkartuschen, Tinten für Digitalkopierer und Thermotransferrollen) mit ihrem Firmennamen und/oder Logo sowie mit Kontaktinformationen zu versehen. So wissen Verbraucher immer, bei wem sie Produkte nachbestellen können. Für eine einmalige, geringe Bearbeitungsgebühr entwirft und produziert Katun Performance vollfarbige Etiketten nach Ihren eigenen Angaben. Diese werden kostenfrei auf die entsprechenden Verpackungen aufgebracht. Unter dieses Programm fallen nur Produkte, die vom Endverbraucher nachbestellt werden können. Die Teilnahme an dem Programm ist ganz einfach. Füllen Sie einfach die Vereinbarung aus und senden Sie diese an Ihren Katun- Ansprechpartner oder besuchen Sie uns auf unserer Homepage unter Firmenetiketten-Programm für weitere Information zu diesem Programm und den Teilnahmebedingungen.



# Personalized Product Agreement

## Customer Information

Customer Number: \_\_\_\_\_ Phone Number: \_\_\_\_\_  
 Contact Name: \_\_\_\_\_ Fax Number: \_\_\_\_\_  
 Title: \_\_\_\_\_ Katun Representative: \_\_\_\_\_

### Customer agrees to:

- Provide pertinent information, a scanable copy of your company logo, or other desired label artwork, and color specifications for the labels.
- Pay a one-time, nominal setup fee upon approval of the label design. (Ask your sales representative for details.)
- Order in full master carton quantities.

### Katun agrees to:

- Create a personalized, full-color label design to your specifications, per the information provided on page two of this form, for a one-time, nominal setup fee and send a proof for approval within a minimum of 7 days of receipt of this agreement.
- Produce labels printed with the customer's approved design on white label stock, and affix them over the Katun Performance logo\* on copier toner, printer/fax toner cartridge, digital duplicator ink/master packaging.
- Ship initial order within one week after the customer approves their Personalized Product label proof. Reorders will also ship within one week.

## Projected Personalized Product Purchases

<i>Katun Part Number**</i>	<i>OEM Line</i>	<i>Product/Model Description</i>	<i>Minimum Order Quantity</i>	<i>Projected Monthly Order***</i>
P			<i>One master carton</i>	
P			<i>One master carton</i>	
P			<i>One master carton</i>	
P			<i>One master carton</i>	
P			<i>One master carton</i>	
P			<i>One master carton</i>	

Signature: \_\_\_\_\_ Date: \_\_\_\_\_

\*Only Katun Performance products can be personalized.

\*\*The Personalized Product part number is the regular Katun Performance part number with a 'P' added at the end. See the Katun catalog for master carton quantities.

\*\*\***Projection only.** You are not committed to ordering the quantity you list on this form.

NOTE: Products with personalized labels cannot be returned to Katun for credit unless a valid warranty claim exists.

**Please Also Complete Page 2**



## Central/Eastern Europe

Telephone: 31(0)183-696969

Fax: 31(0)183-629055

E-mail: [order@edc.katun.com](mailto:order@edc.katun.com)

### **Information for Personalized Product Label**

Please list *only* the information you want to appear on your Personalized Product label.

**Company Name:** \_\_\_\_\_

**Street Address:** \_\_\_\_\_

**City:** \_\_\_\_\_

**State/Province:** \_\_\_\_\_ **Postal Code:** \_\_\_\_\_

**Phone Number:** \_\_\_\_\_ **Fax Number:** \_\_\_\_\_

**Other:** \_\_\_\_\_

### **Label Artwork**

- **Attach a copy of your company logo and/or any other requested graphic elements.** Artwork may be full color or black and white. We prefer original-quality artwork 4" x 4" (100mm x 100mm) or larger, but will accept a business card or sheet of company letterhead.
- **Please indicate your color preferences.** In the space below, please indicate the color(s) you want to use for all text, your company logo, and any other graphic elements. If appropriate, please supply accurate samples to be matched or specify Pantone or PMS color numbers. **NOTE:** Your labels will be printed on a thermal-transfer printer at a resolution of 300 dpi. Therefore color photographs cannot be printed and some colors may be difficult to match precisely.

### **Label Sizes**

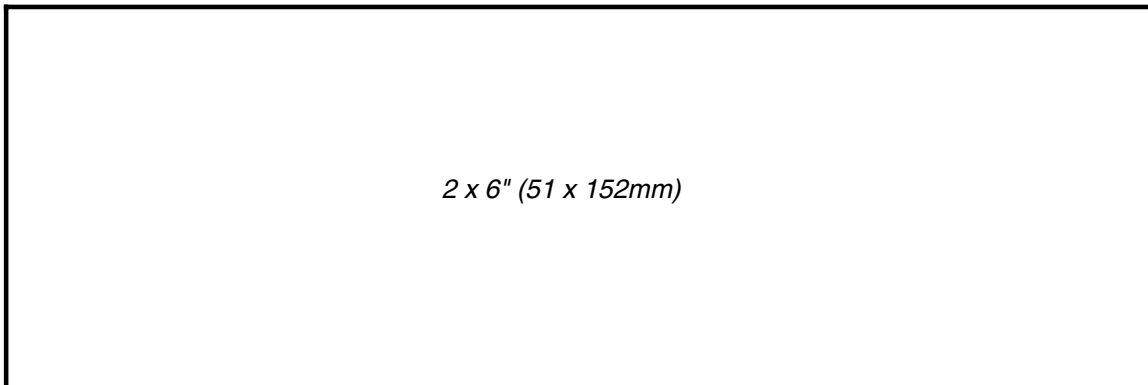
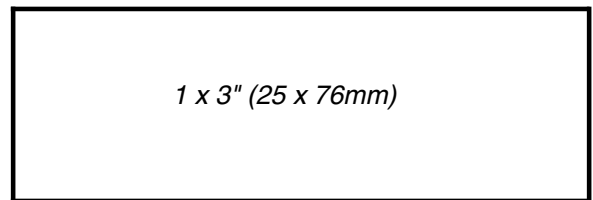
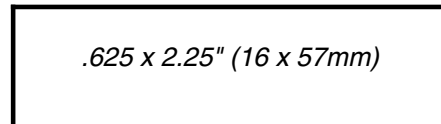
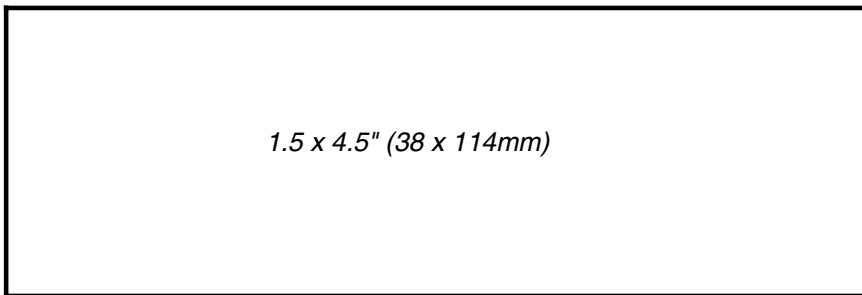

## Vereinbarung über Bestellung von Produkten mit Ihrem Firmenetikett

### Kundeninformationen

Kundennummer: \_\_\_\_\_ Telefon: \_\_\_\_\_  
 Ansprechpartner: \_\_\_\_\_ Fax: \_\_\_\_\_  
 Position: \_\_\_\_\_ Ihr Katun-Repräsentant: \_\_\_\_\_

### Der Kunde ist einverstanden:

- Katun die benötigten Informationen vorzulegen (ein zum Scannen geeignetes Muster Ihres Firmenlogos bzw. Muster anderer gewünschter Grafikelemente sowie Farbspezifikationen für die Etiketten);
- nach Genehmigung des Etiketten-Layouts eine einmalige, geringe Bearbeitungsgebühr zu entrichten. Weitere Informationen erhalten Sie von Ihrem Katun-Repräsentanten;
- Toner in den jeweiligen Verpackungseinheiten/Umkartons zu bestellen.

### Katun verpflichtet sich:

- ein Vollfarbetikett nach den Kundenangaben zu entwerfen (siehe Seite 2 dieses Formulars). Hierfür wird eine einmalige, geringe Bearbeitungsgebühr erhoben. Nach Eingang dieser Vereinbarung bei Katun erhält der Kunde innerhalb von ca. sieben Werktagen einen Korrekturabzug.
- Etiketten in Standardgröße mit dem vom Kunden genehmigten Layout auf weißem Etikettenpapier zu drucken und über dem Katun Performance-Logo\* auf der Verpackung von Toner für Kopierer, Tonerkartuschen für Drucker/Faxgeräte, Tinte bzw. deren Umkartons für digitale Duplikatoren anzubringen.
- den Toner-Erstauftrag innerhalb von einer Woche nach Genehmigung des firmeneigenen Etiketts zu versenden. Nachbestellungen werden ebenfalls innerhalb einer Woche erledigt.

### Erwartete Abnahmemenge von Produkten mit Ihrem Firmenetikett

Katun Artikelnummer**	Maschinenlinie	Produkt-/Modellbeschreibung	Mindestmenge	Erwartete monatliche Bestellung***
P			Ein Umkarton	
P			Ein Umkarton	
P			Ein Umkarton	
P			Ein Umkarton	
P			Ein Umkarton	
P			Ein Umkarton	

Unterschrift: \_\_\_\_\_ Datum: \_\_\_\_\_

\*Nur Katun Performance Produkte können mit Firmenetiketten bestellt werden.

\*\*Die Artikelnummer für Produkte mit Ihrem Firmenetikett ist die normale Katun Performance Artikelnummer, der ein "P" am Ende nachgestellt ist. Sehen Sie die Umkartonmengen im Katun-Katalog nach.

\*\*\*Nur Schätzungen. Sie sind nicht verpflichtet, die hier angegebene Menge abzunehmen.

HINWEIS: Produkte mit Firmenetiketten können nur bei einer berechtigten Reklamation gutgeschrieben werden.

**Füllen Sie bitte auch Seite 2 aus.**



## Bestellinformationen für firmeneigenes Etikett

Geben Sie bitte *nur* die Informationen an, die auf dem Etikett erscheinen sollen.

Name der Firma: \_\_\_\_\_

Strasse: \_\_\_\_\_

PLZ/Ort: \_\_\_\_\_

Telefon: \_\_\_\_\_ Fax: \_\_\_\_\_

Sonstiges: \_\_\_\_\_

## Layout des Etiketts

- **Bitte legen Sie kein Muster Ihres Firmenlogos sowie ggf. Muster anderer gewünschter Grafikelemente bei.** Geeignet sind Grafiken in Farbe oder Schwarzweiß, vorzugsweise Originale mit einer Mindestgröße von 100 x 100 mm. Wir können auch Ihre Visitenkarte oder Ihren Briefkopf verarbeiten.
- **Bitte geben Sie die gewünschten Farben an.** Tragen Sie unten bitte die Farbe(n) für alle Textelemente, Ihr Firmenlogo sowie andere grafische Elemente ein. Legen Sie ggf. ein Farbmuster bei, oder geben Sie die Pantone- bzw. PMS-Farbnummern an. **HINWEIS:** Ihre Firmenetiketten werden auf einem Thermodrucker mit einer Auflösung von 300 DPI erstellt. Es können daher keine Farbfotos gedruckt werden, und bestimmte Farben können u. U. nicht exakt wiedergegeben werden.





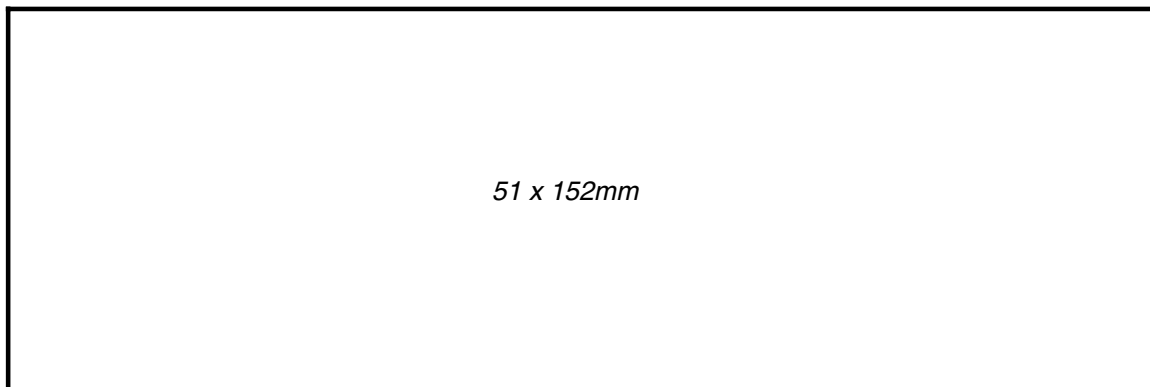
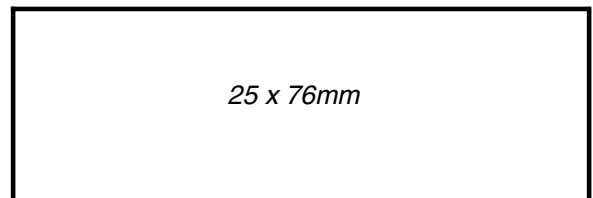
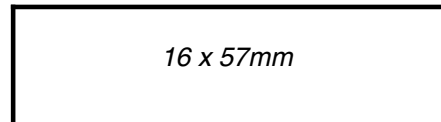
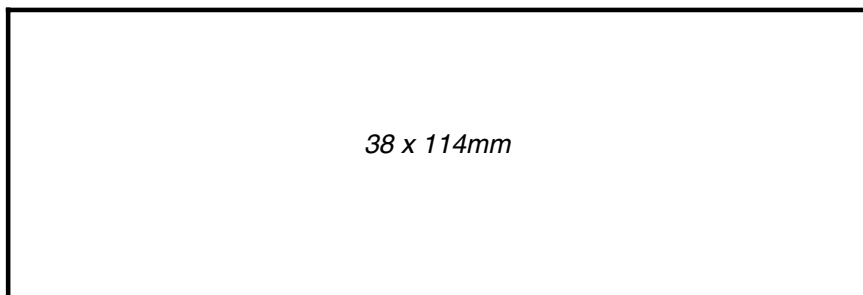





## Etikettengrößen















For use in  
**Nashuatec**  
 Copiers

**Central/Eastern Europe**  
 Telephone: 31(0)183-696969  
 Fax: 31(0)183-629055  
 E-mail: order@edc.katun.com

OEM PN	KATUN PN	DESCRIPTION	MODEL NO.
<b>Bearings/Bushings</b>			
08053087	85576107 	<b>Bearing</b> Various Applications	1210, 1215, 1218, 1220, 1220 -DF, 1220 -S, 1230, 1230 -DF, 1240, 1240 -S, 1250, 1260, 1270, 1280, 1280 -DF, 1290, 1290 -DF, 4172, 4200, 4400, 4400 S, 4600, 4600 S, 4790 MK1, 4790 MK2, 4965, 6160
08053036	85576118 	<b>Bearing</b> Various Applications	1210, 1215, 1218, 1220, 1220 -DF, 1220 -S, 1230, 1230 -DF, 1260, 53101
07420080	85576205 	<b>Pump Motor Ball Bearing</b>	1220, 1220 -DF, 1220 -S, 1230, 1230 -DF, 1240, 1240 -S, 1250, 1260, 1270, 1280, 1280 -DF, 1290, 1290 -DF
08053104	85576205 	<b>Bearing</b> Various Applications  Lower Fuser Roller	1280, 1280 -DF, 1290, 1290 -DF, 3018, 3120, 3222, 3320, 3322, 3415, 4200, 4400, 4400 S, 4600, 4600 S, 7112, C 315, C 503, C 503 D, C 503 De 3133, 3133 L, 3133 LD, 3227, 3227 L, 3227 LD, 4100, 4110, 4115, 4510 z, 4550 z, 5130, 5131, 7125
G0524618	85021628 	<b>Upper Fuser Roller Bearing</b>	1505, 1805, 1805 D, 2705, D 422, D 427, D 2205, D 2705, DSM 615, DSM 618, DSM 618 D
07403008	85576205 	<b>Bearing</b> Various Applications	1505, 1805, 1805 D, 3035, 3133, 3133 L, 3133 LD, 3135 D, 3227, 3227 L, 3227 LD, 3522, 3522 td, 3527, 3527 t, 3527 td, 3535, 3535 t, 3535 td, 3632, 3640, 3722, 3722 td, 3732, 3732 td, 3740, 3740 t, 3740 td, 3943, 3943 d, 4050, 4851, 4860, 4870, 5130, 5131, 7120, 7125, 7130, 7140, 7150, 7150 C, 7150 D, 37105, 53101, C 406, C 606, C 606 E, D 209, D 431, D 455, D 465, D 485, D 555, D 570, D 3640, D 4105, D 5505, D 8505, D 10505, DSc 224, DSc 232, CFN- 55, CRF- 55, RT- 33, RT- 42, SP- 4050, SR- 700, SR- 760, T- 428
A2323553	85576118 	<b>Bearing</b>	2705, 3525, 4525, D 435, D 435 s, D 445, D 2205, D 2705, D 3525, DSc 38 +
AE030003	85021630 	<b>Upper Fuser Roller Bearing</b> Various Applications  Front	3133, 3133 L, 3133 LD, 3322 S, 3415, 7120, 8115, D 4850 3018, 3115, 3120, 3222, 3320, 3322
08053377	85021530 	<b>Upper Fuser Roller Bearing</b>	3035, 3135 D, 3227, 3227 L, 3227 LD, 3943, 3943 d, 4050, 4100, 4110, 4115, 4300, 4310, 4325 z, 4510 z, 4550 z, 5120, 5130, 5131, 7125, 7130, 7140, 7150, 7150 C, 7150 D, D 209, D 431



OEM PN	KATUN PN	DESCRIPTION	MODEL NO.	
<b>Bearings/Bushings</b>				
08053291	85576233 	<b>Bearing</b> Various Applications	3035, 3135 D, 3943, 3943 d, 4050, 4100, 4110, 4172, 4280, 4280 rdh, 4345, 4355, 4365, 4580 rdh, 4582, 4651, 4660, 4670, 4790 MK1, 4790 MK2, 4851, 4860, 4870, 4965, 5130, 5131, 7125, 7130, 7140, 7150, 7150 C, 7150 D, D 431, ARDF- 6160, CB- 150, CRDH- 55, F- 140, F- 513, LCT- 4965, RF- II, SORTER- 4172, SR- 313, SR- 4050, SR- 4965, SS- 428 A, SS- 428 B, ST- 27 A, ST- 27 B	
AE032001	85576262 	<b>Heat Insulating Sleeve</b> Various Applications  Lower	3035, 3135 D, 3943, 3943 d, 4050, 7140, 7150, 7150 C, 7150 D, D 209, D 431 4172, 4280, 4280 rdh, 4580 rdh, 4582, 4965	<i>Priced per Heat Sleeve, sold in Packages of 10.</i>
AE030002	85576107 	<b>Lower Fuser Roller Bearing</b>	3035, 3135 D, 3943, 3943 d, 4050, 7150, 7150 C, 7150 D, C 302	
75720060	85013292 	<b>Upper Fuser Roller Bushing</b>	3118, 3417, 3515, 3523, 3530, 3618, 3916, 3916 D, 3916 L, 3916 R, 3916 S	<i>Priced per Bushing, sold in Bags of 10.</i>
60912270	85576233 	<b>Bearing</b> Various Applications	3417, 3523, 3530, 3540, 3618	
77020010	85576205 	<b>Lower Fuser Roller Bearing</b>	3417, 3523, 3530, 3618	
AE030022	85576221 	<b>Lower Fuser Roller Bearing</b>	3522, 3522 td, 3527, 3527 t, 3527 td, 3535, 3535 t, 3535 td, 3632, 3640, 3722, 3722 td, 3732, 3732 td, 3740, 3740 t, 3740 td, D 440, D 3640	
AE030023	85021628 	<b>Upper Fuser Roller Bearing</b>	3522, 3522 td, 3527, 3527 t, 3527 td, 3535, 3535 t, 3535 td, 3632, 3722, 3722 td, 3732, 3732 td	
A2323566	85576233 	<b>Bearing</b>	3525, 4525, CS 506, CS 506 d, CS 506 de, CS 513 d, D 435, D 435 s, D 445, D 455, D 465, D 485, D 555, D 570, D 3525, D 4105, D 5505, D 6005, D 7505, D 8505, D 10505, RT- 42	
A2323552	85576118 	<b>Bearing</b>	3525, 4525, CS 510, CS 510 E, CS 513 d, D 435, D 435 s, D 445, D 3525, DF- 67, PS- 360, PS- 380, PS- 390	
AE030047	85021630 	<b>Upper Fuser Roller Bearing</b>	3525, 4525, D 3525	
AE030048	85576204 	<b>Lower Fuser Roller Bearing</b>	3525, 4525, D 3525	
65420060	85016005 	<b>Upper Fuser Roller Bearing</b>	3530	

















For use in  
**Nashuatec**  
 Copiers

**Central/Eastern Europe**  
 Telephone: 31(0)183-696969  
 Fax: 31(0)183-629055  
 E-mail: order@edc.katun.com

OEM PN	KATUN PN	DESCRIPTION	MODEL NO.
--------	----------	-------------	-----------

## Bearings/Bushings



















07423808	85576233 	<b>Bearing</b> Various Applications	3535, 3535 t, 3535 td, 3632, 3640, 3732, 3732 td, 3740, 3740 t, 3740 td, 4172, 4280, 4280 rdh, 4345, 4355, 4365, 4580 rdh, 4582, 4651, 4660, 4670, 4965, 5307, 6160, 37105, 53101, C 240, C 302, C 315, C 406, C 606, C 606 E, CS 510, CS 510 E, CS 513 d, D 440, D 455, D 465, D 485, D 555, D 570, D 3640, D 4105, D 4850, D 5505, D 6005, D 7505, D 8505, D 10505, CFN- 101, CRF- 55, DF- 70, DIG LCT- D, LCT- 4965, RF- II, RT- 33, RT- 34, RT- 43, SR- 760, SR- 800, ST- 428
AE030026	85021630 	<b>Upper Fuser Roller Bearing</b>	3640, 3740, 3740 t, 3740 td
A1904086	85016690 	<b>Upper Fuser Roller Bushing</b>	3715, 3718, 3913, D 420
28107400	85576233 	<b>Bearing</b> Various Applications Various Applications	RADF, RADF- 6, SK- 1 3916 D, 3916 L, 4285, 4460, 4592, 4680
52054321	85576210 	<b>Heat Insulating Sleeve</b>	4100, 4110, 4115, 4300, 4310, 4325 z, 4510 z, 4550 z, 5120, 5130, 5131, 7125, 7130
AE030010	85576216 	<b>Upper Fuser Roller Bearing</b>	4172, 4280, 4280 rdh, 4580 rdh, 4582, 4790 MK1, 4790 MK2, 4965, 6160
AE030011	85576224 	<b>Lower Fuser Roller Bearing</b>	4172, 4280, 4280 rdh, 4580 rdh, 4582, 4965
08053300	85576204 	<b>Bearing</b> Various Applications	4172, 4790 MK1, 4790 MK2, 4965, 6160
G3060000	85576107 	<b>Bearing</b> Various Applications	4285, 4592
G3169070	85576216 	<b>Upper Fuser Roller Bearing</b>	4285, 4592, 4680
08053368	85576233 	<b>Bearing</b> Various Applications	4300, 4310, 4325 z, C 503, C 503 D, C 503 De, D 440, D 455, D 465, D 555, D 570, D 3640, D 4850, D 5505, D 6005, D 7505, SP- 4050, SR- 810
AE030017	85015632 	<b>Upper Fuser Roller Bearing</b>	4345, 4355, 4365, 4651, 4660, 4670, 4851, 4860, 4870, D 455, D 465, D 555, D 570, D 5505, D 6005, D 7505
AE030018	85015633 	<b>Lower Fuser Roller Bearing</b>	4345, 4355, 4365, 4651, 4660, 4670, 4851, 4860, 4870, D 455, D 465, D 555, D 570, D 5505, D 6005, D 7505
AE032014	85015648 	<b>Heat Insulating Sleeve</b>	4345, 4355, 4365, 4651, 4660, 4670, D 455, D 465, D 555, D 570, D 6005, D 7505

*Priced per Bushing,  
sold in Boxes of 10.*

*Priced per Heat Sleeve,  
sold in Bags of 10.*

*Priced per Heat Sleeve,  
sold in Bags of 10.*





OEM PN	KATUN PN	DESCRIPTION	MODEL NO.
<b>Bearings/Bushings</b>			
45529400	85021630 	<b>Upper Fuser Roller Bearing</b>	4460
73820070	85015755 	<b>Heat Insulating Sleeve</b>	4460
			<i>Priced per Heat Sleeve, sold in Bags of 10.</i>
G3006880	85576118 	<b>Bearing</b> Various Applications	4460, 4680
G3006860	85015954 	<b>Bearing</b> Various Applications	4680, F- 812
54464090	85021526 	<b>Upper Fuser Roller Bearing</b>	4790 MK1, 4790 MK2, 6160, 37105, 53101
AE032020	85015648 	<b>Heat Insulating Sleeve</b>	4851, 4860, 4870
			<i>Priced per Heat Sleeve, sold in Bags of 10.</i>
52194624	85576131 	<b>Lower Fuser Roller Bearing</b>	6160, 37105, 53101
72120040	85576225 	<b>Upper Fuser Roller Bearing</b>	8120, 8122, 8122 S
72120060	85576205 	<b>Lower Fuser Roller Bearing</b>	8120, 8122, 8122 S
AE030015	85576217 	<b>Upper Fuser Roller Bearing</b>	C 302, C 406, C 606, C 606 E, CS 506, CS 506 d, CS 506 de, CS 510, CS 510 E
AE030039	85576217 	<b>Upper Fuser Roller Bearing</b>	CS 513 d
B0234559	85576204 	<b>Bearing</b>	CS 513 d
AE030049	85016005 	<b>Upper Fuser Roller Bearing</b> Front	CS 525, CS 531
AE030029	85021628 	<b>Upper Fuser Roller Bearing</b>	D 422, D 427
A2244173	85016005 	<b>Upper Fuser Roller Bearing</b>	D 425
A2323559	85021630 	<b>Upper Fuser Roller Bearing</b>	D 435, D 435 s, D 445
A2323560	85576204 	<b>Lower Fuser Roller Bearing</b>	D 435, D 435 s, D 445
AE030021	85021628 	<b>Upper Fuser Roller Bearing</b>	D 440, D 3640
AE032018	85016680 	<b>Heat Insulating Sleeve</b>	D 440, D 3640, D 4850
			<i>Priced per Heat Sleeve, sold in Packages of 10.</i>

For use in  
**Nashuatec**  
Copiers















**Central/Eastern Europe**  
Telephone: 31(0)183-696969  
Fax: 31(0)183-629055  
E-mail: [order@edc.katun.com](mailto:order@edc.katun.com)

OEM PN	KATUN PN	DESCRIPTION	MODEL NO.
-----------	-------------	-------------	--------------

### Bearings/Bushings



















AE030035	85576118 	<b>Bearing</b>	D 485, D 4105, D 8505, D 10505
AE030027	85576221 	<b>Lower Fuser Roller Bearing</b>	D 4850



OEM PN	KATUN PN	DESCRIPTION	MODEL NO.
<b>Belts</b>			
A1573870	85018007 	<b>Transfer Belt</b>	3522, 3522 td, 3527, 3527 t, 3527 td, 3632, 3722, 3722 td, 3732, 3732 td
A2323880	85018006 	<b>Transfer Belt</b>	3525, 4525, D 435, D 435 s, D 445, D 3525
A1763870	85017823 	<b>Transfer Belt</b>	3535, 3535 t, 3535 td, 3640, 3740, 3740 t, 3740 td, 4345, 4355, 4365, 4651, 4660, 4670, 4851, 4860, 4870
63208180	85012037 	<b>Original Document Feed Belt</b>	4460, 4680, UDH
A6801481	85017565 	<b>Original Document Feed Belt</b>	D 435, D 435 s, D 445, D 455, D 465, DF- 67
A2293852	85018005 	<b>Transfer Belt</b>	D 455, D 465, D 485
A2943962	85018005 	<b>Transfer Belt</b>	D 455, D 465, D 485, D 4105
A2933899	85018005 	<b>Transfer Belt</b>	D 555, D 570, D 5505, D 6005, D 7505
59608000	85019644 	<b>Original Document Feed Belt</b>	ADF- 6
A4971125 <i>Final Inventory</i>	85012185 	<b>Original Document Feed Belt</b>	CRDH- 55, RF- 3
A3762196	85018572 	<b>Original Document Feed Belt</b>	CRF- 55
A5481482	85014087 	<b>Original Document Feed Belt</b>	DF- 64
A4651127	85016610 	<b>Original Document Feed Belt</b>	F- 321, F- 811, RF- 3020
57904580	85012545 	<b>Original Document Feed Belt</b>	RADF- 4
65708010 <i>Final Inventory</i>	85021609 	<b>Original Document Feed Belt</b> Fabric Reinforced	RADF- 5, RADF- 6

For use in  
**Nashuatec**  
 Copiers

**Central/Eastern Europe**  
 Telephone: 31(0)183-696969  
 Fax: 31(0)183-629055  
 E-mail: order@edc.katun.com

OEM PN	KATUN PN	DESCRIPTION	MODEL NO.
<b>Blades/Brushes</b>			
54032681	85247105 	<b>Drum Cleaning Blade</b> USA LTT-1	1210, 1215, 1218, 1220, 1220 -DF, 1220 -S, 1230, 1230 -DF, 1260, 1270
B0392289	85021585 	<b>Drum Cleaning Blade</b>	1505, 1805, 1805 D
63818012	85014640 	<b>Drum Cleaning Blade</b>	2310, 3310, 3412
N/P/N	85021494 	<b>Drum Cleaning Blade</b>	2705, D 422, D 427, D 2205, D 2705, D 3205
A0483565	85000719 	<b>Drum Cleaning Blade</b>	3018, 3115, 3120, 3222, 3320, 3322, 7120
AD042011	85012707 	<b>Drum Cleaning Brush</b> Looped Type	3018, 3115, 3120, 3222, 3320, 3322, 7120
AD042015	85236335 	<b>Drum Cleaning Brush</b>	3035, 3135 D, 3943, 3943 d, 4050, 7150, 7150 C, 7150 D
AE043003	85009413 	<b>Fuser Oil Blade</b>	3035, 3135 D, 3943, 3943 d, 4050, 7150, 7150 C, 7150 D, C 240, C 302, C 315
A0073565	85244536 	<b>Drum Cleaning Blade</b>	3035, 3135 D, 3943, 3943 d, 4510 z, 4550 z, 5130, 5131, 7125, 7125 II, 7125 S, 7130, 7140, 7150, 7150 C, 7150 D
A0123580	85011201 	<b>Bias Roller Cleaning Blade</b>	3035, 3135 D, 3943, 3943 d, 7140, 7150, 7150 C, 7150 D, D 209
73918030	85243449 	<b>Upper Drum Cleaning Blade</b>	3114, 3114 L, 8112, 8112 RE
73918030	85022576 	<b>Upper Drum Cleaning Blade</b> <b>Access By Katun</b>	3114, 3114 L, 8112, 8112 RE
73920080	85012697 	<b>Fuser Roller Cleaning Blade</b>	3118, 3417, 3515, 3523, 3530, 3618, 3916, 3916 D, 3916 L, 3916 R, 3916 S, 8112, 8112 RE
75718022	85013179 	<b>Drum Cleaning Blade</b>	3118, 3515, 3916, 3916 D, 3916 L, 3916 R, 3916 S
AD002017	85011819 	<b>Drum Cleaning Blade</b>	3133, 3133 L, 3133 LD, 3227, 3227 L, 3227 LD
AD042016	85012707 	<b>Drum Cleaning Brush</b> Looped Type	3133, 3133 L, 3133 LD, 3227, 3227 L, 3227 LD
AD002018	85010492 	<b>Drum Cleaning Blade</b>	3213, 3213 L, 3213 S
A1283562	85015470 	<b>Drum Cleaning Blade</b>	3322 S, 3415
AD002044	85012935 	<b>Drum Cleaning Blade</b>	3413, 3413 S, 3713, 3713 S

*Priced per Blade,  
 sold in Packages of 5.*

















Katun Performance Product





© 2004 Katun Corporation

OEM PN	KATUN PN	DESCRIPTION	MODEL NO.
<b>Blades/Brushes</b>			
AD002044	85022578	<b>Drum Cleaning Blade</b> Access By Katun	3413, 3413 S, 3713, 3713 S
66018023	85012929	<b>Drum Cleaning Blade</b>	3417
A1532277	85016042	<b>Drum Cleaning Blade</b>	3522, 3522 td, 3527, 3527 t, 3527 td, 3535, 3535 t, 3535 td, 3632, 3640, 3722, 3722 td, 3732, 3732 td, 3740, 3740 t, 3740 td
A1533892	85013283	<b>Transfer Belt Cleaning Blade</b>	3522, 3522 td, 3527, 3527 t, 3527 td, 3535, 3535 t, 3535 td, 3632, 3640, 3722, 3722 td, 3732, 3732 td, 3740, 3740 t, 3740 td
A2042120	85016230	<b>Drum Charge Roller Cleaning Blade</b>	3522, 3522 td, 3527, 3527 t, 3527 td, 3535, 3535 t, 3535 td, 3632, 3640, 3722, 3722 td, 3732, 3732 td, 3740, 3740 t, 3740 td
66218092	85015554	<b>Drum Cleaning Blade</b>	3523, 3618
A2322353	85017343	<b>Drum Cleaning Blade Assembly</b>	3525, 4525, D 435, D 435 s, D 445, D 3525
A2323830	85018035	<b>Transfer Belt Cleaning Blade</b>	3525, 4525, D 435, D 435 s, D 445, D 3525
60918040	85011228	<b>Drum Cleaning Blade</b>	3530
67318020	85013906	<b>Drum Cleaning Blade</b>	3540
A1903550	85016502	<b>Drum Cleaning Blade</b>	3715, 3715 +, 3718, 3718 +, 3913, 3913 S
A1903550	85022579	<b>Drum Cleaning Blade</b> Access By Katun	3715, 3715 +, 3718, 3718 +, 3913, 3913 S
A0533663	85011721	<b>Drum Cleaning Blade</b>	4050
A0793618	85011803	<b>Drum Cleaning Blade</b>	4280, 4280 rdh, 4580 rdh, 4582
52093565 <i>Final Inventory</i>	85243444	<b>Drum Cleaning Blade</b> USA Designed to minimize noise.	4300, 4310, 4325 z
AD042023	85012552	<b>Drum Cleaning Brush</b>	4345, 4355, 4365
A0963938	85016438	<b>Transfer Belt Cleaning Blade</b>	4345, 4355, 4365, 4651, 4660, 4670
AD042032	85019441	<b>Drum Cleaning Brush</b>	4345, 4355, 4365, 4651, 4660, 4670
A1763582	85012544	<b>Drum Cleaning Blade</b>	4345, 4355, 4365, 4651, 4660, 4670, 4851, 4860, 4870

For use in  
**Nashuatec**  
 Copiers











**Central/Eastern Europe**  
 Telephone: 31(0)183-696969  
 Fax: 31(0)183-629055  
 E-mail: order@edc.katun.com













OEM PN	KATUN PN	DESCRIPTION	MODEL NO.
<b>Blades/Brushes</b>			
61718041 <i>Final Inventory</i>	85013907 	<b>Drum Cleaning Brush</b>	4460
77618310	85243494 	<b>Drum Cleaning Blade</b>	4460, 4680
52113568 <i>Final Inventory</i>	85243444 	<b>Drum Cleaning Blade</b> USA Designed to minimize noise.	5120
52154117	85009414 	<b>Fuser Oil Blade</b>	5130, 5131, 7125, 7125 II, 7125 S, 7130, 7140, D 209, D 431
43229205 <i>Final Inventory</i>	85243452 	<b>Seal Blade</b>	8120, 8122, 8122 S
77718060	85243463 	<b>Drum Cleaning Blade</b>	8120, 8122, 8122 S
A1093598	85014609 	<b>Drum/Transfer Belt Cleaning Blade</b>	C 406
G0203550	85016219 	<b>Drum Cleaning Blade</b>	D 420, D 425
A1342275	85016734 	<b>Drum Cleaning Blade</b>	D 440, D 3640, D 4850
A1343945	85018666 	<b>Transfer Belt Cleaning Blade</b>	D 440, D 3640, D 4850
AD041049	85018852 	<b>Transfer Belt Cleaning Blade</b>	D 455, D 465
AD041056	85012544 	<b>Drum Cleaning Blade</b>	D 455, D 465, D 485, D 555, D 570, D 4105, D 5505, D 8505, D 10505
AD042038	85023241 	<b>Drum Cleaning Brush</b> Various Applications with Enhancement Kit	D 455, D 465, D 8505, D 10505 D 485, D 4105
A2943883	85019861 	<b>Transfer Belt Cleaning Blade</b>	D 485, D 4105, D 8505, D 10505
A2933918	85019862 	<b>Transfer Belt Cleaning Blade</b>	D 555, D 570, D 5505

OEM PN	KATUN PN	DESCRIPTION	MODEL NO.
<b>Corona/Charge/Transfer</b>			
N/P/N	85375558 	<b>Corona Wire Spool</b> 50 m / Spool 80μ Unpolished Charge Transfer	215, 220, 230 1210, 1215, 1218, 1220, 1220 -DF, 1220 -S, 1230, 1230 -DF, 1240, 1240 -S, 1250, 1270, 1280, 1280 -DF, 1290, 1290 -DF, 4200, 4400, 4400 S, 4600, 4600 S
N/P/N	85375228 	<b>Corona Wire Spool</b> Platinum alloy clad technology extends corona wire life. 60μ 7.5 m / Spool Charge Charge, Discharge  Charge, Discharge, Cleaning  Transfer, Discharge Transfer, Separation  Transfer All Applications	1205 1210, 1215, 1218, 1220, 1220 -DF, 1220 -S, 1230, 1230 -DF, 1270  1240, 1240 -S, 1250, 1280, 1280 -DF, 1290, 1290 -DF, 4200, 4400, 4400 S, 4600, 4600 S  1260 3114, 3114 L, 3118, 3515, 3916, 3916 D, 3916 L, 3916 R, 3916 S, 4460, 4680, 8112, 8112 RE 3412, 3417, 3523, 3618 4285, 4592
N/P/N	85375230 	<b>Corona Wire Spool</b> Platinum alloy clad technology extends corona wire life. 80μ 7.5 m / Spool Transfer  All Applications	1210, 1215, 1218, 1220, 1220 -DF, 1220 -S, 1230, 1230 -DF, 1240, 1240 -S, 1250, 1260, 1270, 1280, 1280 -DF, 1290, 1290 -DF, 4200, 4400, 4400 S, 4600, 4600 S 3035, 3135 D, 3943, 3943 d, 4050, 4100, 4110, 4115, 4172, 4280, 4280 rdh, 4300, 4310, 4325 z, 4510 z, 4550 z, 4790 MK1, 4790 MK2, 4965, 5120, 5130, 5131, 6160, 7112, 7125, 7125 II, 7125 S, 7130, 7140, 7150, 7150 C, 7150 D, D 209
41626652	85375138 	<b>Corona Wire Spool</b> 100 m / Spool 50μ Oxidized All Applications Charge  Charge, Transfer	2310, 8108, 8108 C, 8120, 8122, 8122 S 3114, 3114 L, 3118, 3412, 3417, 3515, 3523, 3530, 3540, 3618, 3916, 3916 D, 3916 L, 3916 R, 3916 S, 8112, 8112 RE 3512
A0062111	85013165 	<b>Charge Corona Grid</b>	3018, 3115, 3120, 3222, 3320, 3322, 3322 S, 3415

For use in  
**Nashuatec**  
 Copiers





**Central/Eastern Europe**  
 Telephone: 31(0)183-696969  
 Fax: 31(0)183-629055  
 E-mail: order@edc.katun.com

OEM PN	KATUN PN	DESCRIPTION	MODEL NO.
<b>Corona/Charge/Transfer</b>			
A0489001	85375164 	<b>Corona Wire</b> 60µ Polished Charge	3018, 3115, 3120, 3222, 3320, 3322, 3322 S, 3415  <i>Priced per Set, 10 Corona Wires per Set.</i>
A0489002	85375165 	<b>Corona Wire</b> 60µ Polished Transfer	3018, 3115, 3120, 3222, 3320, 3322, 3322 S, 3415  <i>Priced per Set, 10 Corona Wires per Set.</i>
A0489003	85375166 	<b>Corona Wire</b> 60µ Carbon Coated Separation	3018, 3115, 3120, 3222, 3320, 3322, 3322 S, 3415  <i>Priced per Set, 10 Corona Wires per Set.</i>
A0089001	85375593 	<b>Corona Wire</b> 80µ Carbon Coated Charge	3035, 3135 D, 3943, 3943 d, 4050, 7140, 7150, 7150 C, 7150 D  <i>Priced per Set, 10 Corona Wires per Set.</i>
A0079002	85375592 	<b>Corona Wire</b> 80µ Carbon Coated Precleaning, Prequenching	3035, 3135 D, 3943, 3943 d, 4050, 7150, 7150 C, 7150 D  <i>Priced per Set, 10 Corona Wires per Set.</i>
A0079003	85375595 	<b>Corona Wire</b> 80µ Carbon Coated Transfer	3035, 3135 D, 3943, 3943 d, 4050, 7150, 7150 C, 7150 D  <i>Priced per Set, 10 Corona Wires per Set.</i>
A0079004	85375594 	<b>Corona Wire</b> 80µ Carbon Coated Separation	3035, 3135 D, 3943, 3943 d, 4050, 7150, 7150 C, 7150 D  <i>Priced per Set, 10 Corona Wires per Set.</i>
42929503	85375139 	<b>Corona Wire Spool</b> 100 m / Spool 60µ 0.3µ Gold Plated Transfer, Separation	3114, 3114 L, 3118, 3515, 3530, 3540, 3916, 3916 D, 3916 L, 3916 R, 3916 S, 4460, 4680, 8112, 8112 RE 3412, 3417, 3523, 3618 4285, 4592
A0692117	85013166 	<b>Charge Corona Grid</b>	3133, 3133 L, 3133 LD, 3227, 3227 L, 3227 LD
A0699540	85011931 	<b>Corona Wire</b> 60µ Polished Charge	3133, 3133 L, 3133 LD, 3227, 3227 L, 3227 LD  <i>Priced per Set, 10 Corona Wires per Set.</i>





OEM PN	KATUN PN	DESCRIPTION	MODEL NO.
<b>Corona/Charge/Transfer</b>			
A0699541	85011932 	<b>Corona Wire</b> 60µ Polished Transfer	3133, 3133 L, 3133 LD, 3227, 3227 L, 3227 LD  <i>Priced per Set, 10 Corona Wires per Set.</i>
A0699542	85011874 	<b>Corona Wire</b> 60µ Carbon Coated Separation	3133, 3133 L, 3133 LD, 3227, 3227 L, 3227 LD  <i>Priced per Set, 10 Corona Wires per Set.</i>
A0772072	85013168 	<b>Charge Corona Grid</b>	3213, 3213 L, 3213 S, 3413, 3413 S, 3713, 3713 S
A0779520	85011933 	<b>Corona Wire</b> 60µ Polished Charge	3213, 3213 L, 3213 S, 3413, 3413 S, 3713, 3713 S  <i>Priced per Set, 10 Corona Wires per Set.</i>
A0779521	85010982 	<b>Corona Wire</b> 60µ Carbon Coated Separation	3213, 3213 L, 3213 S, 3413, 3413 S, 3713, 3713 S  <i>Priced per Set, 10 Corona Wires per Set.</i>
A0779522	85011934 	<b>Corona Wire</b> 60µ Polished Transfer	3213, 3213 L, 3213 S, 3413, 3413 S, 3713, 3713 S  <i>Priced per Set, 10 Corona Wires per Set.</i>
AD027001 <i>Final Inventory</i>	85022700 	<b>Drum Charge Roller</b>	3522, 3522 td, 3527, 3527 t, 3527 td, 3535, 3535 t, 3535 td
A1902060	85016705 	<b>Charge Corona Grid</b>	3715, 3715 +, 3718, 3718 +, 3913, 3913 S
A1902065	85015564 	<b>Corona Wire</b> 60µ Polished Charge	3715, 3715 +, 3718, 3718 +, 3913, 3913 S  <i>Priced per Set, 10 Corona Wires per Set.</i>
52199101	85375591 	<b>Corona Wire</b> 80µ Carbon Coated All Applications	4172, 4280, 4280 rdh, 4965, 6160  <i>Priced per Set, 10 Corona Wires per Set.</i>
52199535	85375591 	<b>Corona Wire</b> 80µ Carbon Coated All Applications	4172, 4280, 4280 rdh, 4965, 6160  <i>Priced per Set, 10 Corona Wires per Set.</i>
A1719504	85375591 	<b>Corona Wire</b> 80µ Carbon Coated All Applications	4280, 4280 rdh, 4580 rdh, 4582  <i>Priced per Set, 10 Corona Wires per Set.</i>
A0962057	85013164 	<b>Charge Corona Grid</b>	4345, 4355, 4365, 4651, 4660, 4670, 4851, 4860, 4870, D 440, D 455, D 465, D 485, D 555, D 570, D 3640, D 4105, D 4850, D 5505, D 6005, D 7505, D 8505, D 10505

For use in  
**Nashuatec**  
 Copiers

**Central/Eastern Europe**  
 Telephone: 31(0)183-696969  
 Fax: 31(0)183-629055  
 E-mail: order@edc.katun.com

OEM PN	KATUN PN	DESCRIPTION	MODEL NO.
<b>Corona/Charge/Transfer</b>			
AD020053	85011439 	<b>Corona Wire</b> 60µ Polished Charge	4345, 4355, 4365, 4651, 4660, 4670, 4851, 4860, 4870, D 440, D 455, D 465, D 485, D 555, D 570, D 3640, D 4105, D 4850, D 6005, D 7505, D 8505, D 10505
			<i>Priced per Set, 10 Corona Wires per Set.</i>
N/P/N	85375549 	<b>Grid Wire Spool</b> 50 m / Spool 100µ Stainless Steel	4460
61768110	85375121 	<b>Grid Wire Spool</b> 50 m / Spool 100µ 0.3µ Gold Plated	4460, 4680
74669000	85011002 	<b>Corona Wire Spool</b> 50 m / Spool 60µ Oxidized Charge	4460, 4680



OEM PN	KATUN PN	DESCRIPTION	MODEL NO.
<b>Developers</b>			
N/P/N	85013565	<b>Black Developer Original</b> 1000 g / Bag	3018, 3115, 3120, 3222, 3320, 3322, 3415, 5307, 55A0, 57A0, 481A0, 482A0
2960903	85013585	<b>Black Developer Original</b> 1000 g / Bag	3018, 3115, 3120, 3222, 3320, 3322, 3415, 7120
12510020	85010573 	<b>Black Developer</b> 310 g / Bottle 10 Bottles per Master Carton	3114, 3114 L
37054110	85010573 	<b>Black Developer</b> 310 g / Bottle 10 Bottles per Master Carton	3114, 3114 L
N/P/N	85013563	<b>Black Developer Original</b> 1000 g / Bag	3133, 3133 L, 3133 LD, 3213, 3213 L, 3213 S, 3227, 3227 L, 3227 LD, 3322 S, 3413, 3413 S, 3713, 3713 S
2960901	85013583	<b>Black Developer Original</b> 1000 g / Bag	3133, 3133 L, 3133 LD, 3213, 3213 S, 3227, 3227 L, 3227 LD, 3413, 3413 S, 3713, 3713 S
N/P/N	85013599	<b>Black Developer Original</b> 1000 g / Bag	3522, 3522 td, 3527, 3527 t, 3527 td, 3535, 3535 t, 3535 td, 3632, 3715 +, 3722, 3722 td, 3740 t, 3740 td, 4345, 4355, 4365, 4651, 4660, 4670
N/P/N	85016407	<b>Black Developer Original</b> 370 g / Bag	3715, 3715 +, 3718, 3718 +, 3913, 3913 S
N/P/N <i>Final Inventory</i>	85013926 	<b>Black Developer</b> 1000 g / Bottle 4 Bottles per Master Carton	4050
N/P/N	85010887 	<b>Black Developer</b> 1000 g / Bottle 4 Bottles per Master Carton	4100, 4110, 4115, 4300, 4310, 4325 z, 4510 z, 4550 z, 5120, 5130, 5131, 7125, 7125 II, 7125 S, 7130
887797	85019853	<b>Black Developer Original</b> 1000 g / Bag	4851, 4860, 4870
N/P/N	85018459	<b>Black Developer Original</b> 500 g / Bag	D 435, D 435 s, D 445
N/P/N	85017101	<b>Black Developer Original</b> 850 g / Bag	D 440, D 3640, D 4850
N/P/N	85018460	<b>Black Developer Original</b> 1000 g / Bag	D 455, D 465

*Priced per Bottle,  
sold per Bottle.*











*Priced per Bottle,  
sold per Bottle.*

*Priced per Carton,  
4 Bottles per Carton.*

*Priced per Carton,  
4 Bottles per Carton.*

For use in  
**Nashuatec**  
 Copiers

**Central/Eastern Europe**  
 Telephone: 31(0)183-696969  
 Fax: 31(0)183-629055  
 E-mail: order@edc.katun.com













OEM PN	KATUN PN	DESCRIPTION	MODEL NO.
<b>Feed/Delivery</b>			
A2672751	85018175 	<b>Paper Feed Roller</b>	2705, D 422, D 427, D 2205, D 2705, PS- 400, PS- 410, PS- 440, PS- 450, PS- 460, PS- 490
52062605	85632327 	<b>Separation Roller</b> Tire Only Various Applications  Duplex	3018, 3115, 3120, 3222, 3320, 3322, 3415, C 302, D 431, DIG LCT- 1, DIG LCT- D  3035, 3135 D, 3943 d, 4050, 4550 z, 7150 C, 7150 D
54472927	85014401 	<b>Friction Pad B</b> Cork Type	3018, 3035, 3120, 3133, 3133 L, 3133 LD, 3135 D, 3222, 3227, 3227 L, 3227 LD, 3320, 3322, 3322 S, 3632, 3640, 3722, 3722 td, 3732, 3732 td, 3740, 3740 t, 3740 td, 3943 d, 4510 z, 4550 z, 5130, 5131, 7112, 7150, 7150 C, 7150 D, C 315, C 406, C 503, C 503 D, C 503 De, C 606, C 606 E, D 431, D 440, D 3640, D 4850
A0752599	85021584 	<b>Torque Limiter</b>	3018, 3115, 3120, 3222
AF030002	85010824 	<b>Paper Pickup Roller</b> Tire Only	3018, 3115, 3120, 3222, 3320, 3322, 3415
AF031006	85010824 	<b>Paper Feed Roller</b> Tire Only	3018, 3115, 3120, 3222, 3320, 3322, 3415
54472693	85632523 	<b>Separation Roller</b> Tire Only	3035, 3135 D, 3900, 3943, 3943 d, 4050, 4100, 4110, 4115, 4510 z, 4550 z, 7112, 7120, 7150, 7150 C, 7150 D, C 240, C 315, CB- 150, EU- C 302
54472723	85632525 	<b>Paper Pickup Roller</b> Tire Only	3035, 3135 D, 3943, 3943 d, 4050, 4100, 4110, 4115, 4510 z, 4550 z, 7112, 7120, 7150, 7150 C, 7150 D, 53101, C 240, C 315, CB- 150, EU- C 302, T- 251
54472726	85009139 	<b>Paper Feed Roller</b> Tire Only	3035, 3135 D, 3943, 3943 d, 4050, 4100, 4110, 4115, 4510 z, 4550 z, 7112, 7150, 7150 C, 7150 D, 53101, C 240, C 315, CB- 150, EU- C 302, T- 251
54472726	85632521 	<b>Paper Feed Roller</b> Tire Only	3035, 3135 D, 3943, 3943 d, 4050, 4100, 4110, 4115, 4510 z, 4550 z, 7112, 7150, 7150 C, 7150 D, 53101, C 240, C 315, CB- 150, EU- C 302, T- 251
N/P/N	85011126 	<b>Feed Tire Replacement Kit</b> Tire Only Kit Contains: • (1) Paper Feed Tire • (1) Separation Tire • (1) Paper Pickup Tire	3035, 3135 D, 3943, 3943 d, 4050, 4100, 4110, 4115, 4510 z, 4550 z, 7112, 7150, 7150 C, 7150 D, C 240, C 315, CB- 150, EU- C 302, RT- 36
AF010003	85010496 	<b>Duplex Paper Feed Roller</b> Tire Only	3035, 3135 D, 3943 d, 4050, 7150 C, 7150 D, C 302, DIG LCT- D

















OEM PN	KATUN PN	DESCRIPTION	MODEL NO.	
<b>Feed/Delivery</b>				
AF031019	85010824 	<b>Paper Feed Roller</b> Tire Only	3133, 3133 L, 3133 LD, 3227, 3227 L, 3227 LD	<i>Priced per Tire, sold in Bags of 10.</i>
AF032019	85632523 	<b>Separation Roller</b> Tire Only	3133, 3133 L, 3133 LD, 3227, 3227 L, 3227 LD	<i>Priced per Tire, sold in Bags of 10.</i>
A0692820	85010227 	<b>Friction Pad Assembly</b> Cork Type "Pad only"	3133, 3133 L, 3133 LD, 3227, 3227 L, 3227 LD, 3322 S	<i>Priced per Friction Pad, sold in Bags of 10.</i>
AF013003	85015684 	<b>Duplex Friction Pad</b> Cork Type	3133, 3133 L, 3133 LD, 3227, 3227 L, 3227 LD, 3522, 3522 td, 3527, 3527 t, 3527 td, 3535, 3535 t, 3535 td, 3632, 3640, 3722, 3722 td, 3732, 3732 td, 3740, 3740 t, 3740 td, CS 506 d, CS 506 de, CS 510, CS 510 E, CS 513 d, CS 531, D 440, D 3640, D 4850	<i>Priced per Friction Pad, sold in Bags of 10.</i>
AF030019	85632525 	<b>Paper Pickup Roller</b> Tire Only	3133, 3133 L, 3133 LD, 3227, 3227 L, 3227 LD, C 315	<i>Priced per Tire, sold in Bags of 10.</i>
A4212543	85015507 	<b>Friction Pad</b> Cork Type	3133, 3133 L, 3133 LD, 3522, 3522 td, 3527, 3527 t, 3527 td, 3535, 3535 t, 3535 td, 3632, 3640, 3722, 3722 td, 3732, 3732 td, 3740, 3740 t, 3740 td, D 440, D 3640, D 4850, PS- 420, PS- 500, RT- 43	<i>Priced per Friction Pad, sold in Bags of 10.</i>
AF030008	85014413 	<b>Paper Pickup Roller</b> Tire Only	3213, 3213 L, 3213 S, 3413, 3413 S	<i>Priced per Tire, sold in Bags of 10.</i>
A2032632	85014413 	<b>Paper Pickup Roller</b> Tire Only	3213, 3213 L, 3213 S, 3413, 3413 S, 3713, 3713 S	<i>Priced per Tire, sold in Bags of 10.</i>
AF030012	85014414 	<b>Support Paper Pickup Roller</b> Tire Only	3413, 3413 S	<i>Priced per Tire, sold in Bags of 10.</i>
A2032635	85014414 	<b>Support Paper Pickup Roller</b> Tire Only	3413, 3413 S, 3713, 3713 S	<i>Priced per Tire, sold in Bags of 10.</i>
AF030024	85009692 	<b>Paper Pickup Roller</b> Tire Only	3522, 3522 td, 3527, 3527 t, 3527 td, 3535, 3535 t, 3535 td, 3632, 3640, 3722, 3722 td, 3732, 3732 td, 3740, 3740 t, 3740 td, C 503, C 503 D, C 503 De	<i>Priced per Tire, sold in Bags of 10.</i>
AF032025	85009692 	<b>Separation Roller</b> Tire Only	3522, 3522 td, 3527, 3527 t, 3527 td, 3535, 3535 t, 3535 td, 3632, 3640, 3722, 3722 td, 3732, 3732 td, 3740, 3740 t, 3740 td, C 503, C 503 D, C 503 De, CS 506, CS 506 d, CS 506 de, CS 525, CS 531	<i>Priced per Tire, sold in Bags of 10.</i>
AF031024	85017811 	<b>Paper Feed Roller</b> Tire Only For duplex unit only	3522, 3522 td, 3527, 3527 t, 3527 td, 3535, 3535 t, 3535 td, 3632, 3640, 3722, 3722 td, 3732, 3732 td, 3740, 3740 t, 3740 td, D 440, D 3640, D 4850	<i>Priced per Tire, sold in Bags of 10.</i>
AF013004	85016956 	<b>Friction Pad</b> Cork Type	3522, 3522 td, 3527, 3527 t, 3527 td, C 503, C 503 D, C 503 De	

For use in  
**Nashuatec**  
Copiers

**Central/Eastern Europe**  
Telephone: 31(0)183-696969  
Fax: 31(0)183-629055  
E-mail: order@edc.katun.com















OEM PN	KATUN PN	DESCRIPTION	MODEL NO.	
<b>Feed/Delivery</b>				
AF031025	85009692 	<b>Paper Feed Roller</b> Tire Only	3522, 3527, 3527 t, 3527 td, 3535, 3535 t, 3535 td, 3632, 3640, 3722, 3722 td, 3740, 3740 t, 3740 td, C 503, C 503 D, C 503 De, CS 506, CS 506 d, CS 506 de, CS 525, CS 531	<i>Priced per Tire, sold in Bags of 10.</i>
60906161	85012115 	<b>Paper Pickup Roller</b> Tire Only Ribbed Tire	3523, 3530, 3618, AD- 53, MD- 6, MD- 9, ST- 5	<i>Priced per Tire, sold in Bags of 10.</i>
66106110	85015401 	<b>Paper Feed Roller</b> Tire Only	3523, 3618, AD- 53, MD- 9, ST- 5	<i>Priced per Tire, sold in Bags of 10.</i>
N/P/N	85020136 	<b>Paper Feed Roller Kit</b> Tire Only For KD 1010 Kit Contains: • (1) Paper Pickup Tire • (1) Separation/Feed Tire • (1) Paper Feed Tire	3525, 4525, CS 506, CS 525, D 435, D 435 s, D 445, D 3525, PS- 360, PS- 380, PS- 390, PS- 420	
AF031035	85018484 	<b>Paper Feed Roller</b> Tire Only	3525, 4525, CS 506, CS 525, D 435, D 435 s, D 445, D 3525, PS- 360, PS- 380, PS- 390, PS- 420, PS- 500	<i>Priced per Tire, sold in Bags of 10.</i>
AF032035	85018483 	<b>Separation Roller</b> Tire Only	3525, 4525, CS 506, CS 525, D 435, D 435 s, D 445, D 3525, PS- 360, PS- 380, PS- 390, PS- 420, PS- 500	<i>Priced per Tire, sold in Bags of 10.</i>
AF030036	85018482 	<b>Bypass Pickup Roller</b> Tire Only	3525, 4525, D 435, D 435 s, D 445, D 3525	<i>Priced per Tire, sold in Bags of 10.</i>
AF031036	85018484 	<b>Bypass Feed Roller</b> Tire Only	3525, 4525, D 435, D 435 s, D 445, D 3525	<i>Priced per Tire, sold in Bags of 10.</i>
AF032036	85018483 	<b>Bypass Separation Roller</b> Tire Only	3525, 4525, D 435, D 435 s, D 445, D 3525	<i>Priced per Tire, sold in Bags of 10.</i>
72707110	85013621 	<b>Bypass Upper Paper Feed Roller</b> Tire Only	3530, 8120, 8122, 8122 S	<i>Priced per Tire, sold in Bags of 10.</i>
60906131	85012114 	<b>Paper Feed Tire</b> Tire Only Ribbed Tire	3530, MD- 6	<i>Priced per Tire, sold in Bags of 10.</i>
AF013014	85015686 	<b>Bottom Plate Friction Pad</b> Cork Type	3535, 3535 t, 3535 td, 3632, 3640, 3732, 3732 td, 3740, 3740 t, 3740 td, CS 506, CS 510, CS 510 E, CS 513 d, CS 525, D 435, D 435 s, D 440, D 445, D 3640, D 4850, PS- 280, PS- 290, PS- 360, PS- 380, PS- 390	<i>Priced per Friction Pad, sold in Bags of 10.</i>
AF030025	85013252 	<b>Paper Pickup Roller</b> Tire Only	3535, 3535 t, 3535 td, 3632, 3640, 3732, 3732 td, 3740, 3740 t, 3740 td, CS 510, CS 510 E, CS 513 d, D 440, D 3640, D 4850, PS- 280, PS- 290	<i>Priced per Tire, sold in Bags of 10.</i>

OEM PN	KATUN PN	DESCRIPTION	MODEL NO.	
<b>Feed/Delivery</b>				
AF031026	85010496 	<b>Paper Feed Roller</b> Tire Only	3535, 3535 t, 3535 td, 3632, 3640, 3732, 3732 td, 3740, 3740 t, 3740 td, CS 510, CS 510 E, CS 513 d, D 440, D 3640, D 4850, PS- 280, PS- 290	<i>Priced per Tire, sold in Bags of 10.</i>
AF032027	85013047 	<b>Separation Roller</b> Tire Only	3535, 3535 t, 3535 td, 3632, 3640, 3732, 3732 td, 3740, 3740 t, 3740 td, CS 510, CS 510 E, CS 513 d, D 440, D 3640, D 4850, PS- 280, PS- 290	<i>Priced per Tire, sold in Bags of 10.</i>
61706770	85020148 	<b>Bypass Upper Separation Roller</b> Tire Only	3540, 4460, 4680	<i>Priced per Tire, sold in Bags of 10.</i>
61706780	85020757 	<b>Bypass Lower Separation Roller</b> Tire Only	3540, 4460, 4680	<i>Priced per Tire, sold in Bags of 10.</i>
A2192555	85020085 	<b>Paper Feed Roller</b>	3715, 3715 +, 3718, 3718 +, 3722, 3722 td, 3913, 3913 S, D 420, D 425	<i>Priced per Feed/Sep Roller, sold in Bags of 4.</i>
G0202721	85019647 	<b>Bypass Feed Roller</b> Tire Only	3715, 3715 +, 3718, 3718 +, 3913, 3913 S, D 420, D 425	<i>Priced per Tire, sold in Bags of 10.</i>
AF030006	85010496 	<b>Paper Pickup Roller</b> Tire Only	4280, 4280 rdh	<i>Priced per Tire, sold in Bags of 10.</i>
AF030015	85010496 	<b>Paper Pickup Roller</b> Tire Only	4280, 4280 rdh, T- 428	<i>Priced per Tire, sold in Bags of 10.</i>
54422637	85010227 	<b>Friction Pad</b> Cork Type "Pad only"	4300, 4310, 4325 z, 5120	<i>Priced per Friction Pad, sold in Bags of 10.</i>
AF032021	85632523 	<b>Separation Roller</b> Tire Only	4345, 4355, 4365, 4580 rdh, 4582, 4651, 4660, 4670, C 406, C 606, C 606 E, D 455, D 465, CLCT- 55, PS- 500, RT- 34, RT- 36	<i>Priced per Tire, sold in Bags of 10.</i>
AF030021	85632525 	<b>Paper Pickup Roller</b> Tire Only	4345, 4355, 4365, 4580 rdh, 4582, 4651, 4660, 4670, C 406, C 606, C 606 E, D 455, D 465, CLCT- 55, RT- 34, RT- 36	<i>Priced per Tire, sold in Bags of 10.</i>
AF030020	85012106 	<b>Paper Pickup Roller</b> Tire Only	4345, 4355, 4365, 4580 rdh, 4582, 4651, 4660, 4670, C 406, C 606, C 606 E, D 455, D 465, RT- 33	<i>Priced per Tire, sold in Bags of 10.</i>
AF031022	85012104 	<b>Paper Feed Roller</b> Tire Only	4345, 4355, 4365, 4580 rdh, 4582, 4651, 4660, 4670, C 406, C 606, C 606 E, D 455, D 465, RT- 33	<i>Priced per Tire, sold in Bags of 10.</i>
AF032023	85012105 	<b>Separation Roller</b> Tire Only	4345, 4355, 4365, 4580 rdh, 4582, 4651, 4660, 4670, C 406, C 606, C 606 E, D 455, D 465, RT- 33	<i>Priced per Tire, sold in Bags of 10.</i>
AF031021	85632521 	<b>Paper Feed Roller</b> Tire Only	4345, 4355, 4365, 4580 rdh, 4582, 4651, 4660, 4670, D 455, D 465, D 485, D 4105, CLCT- 55, RT- 34, RT- 36	<i>Priced per Tire, sold in Bags of 10.</i>



For use in  
**Nashuatec**  
 Copiers

**Central/Eastern Europe**  
 Telephone: 31(0)183-696969  
 Fax: 31(0)183-629055  
 E-mail: order@edc.katun.com









OEM PN	KATUN PN	DESCRIPTION	MODEL NO.	
<b>Feed/Delivery</b>				
A0969501	85014031 	<b>Duplex Separation Belt</b>	4345, 4355, 4365, 4651, 4660, 4670	<i>Priced per Package, 3 Belts per Package.</i>
AF032024	85013192 	<b>Duplex Separation Tire</b> Tire Only	4345, 4355, 4365, 4651, 4660, 4670	<i>Priced per Tire, sold in Bags of 5.</i>
63207540	85015781 	<b>Separation Belt</b>	4680, RADF, RADF- 5, RADF- 6	<i>Priced per Belt, sold in Packages of 6.</i>
AF030040	85020064 	<b>Paper Pickup Roller</b> Tire Only	4851, 4860, 4870, D 485, D 555, D 570, D 4105, D 5505, D 8505, D 10505	<i>Priced per Tire, sold in Bags of 3.</i>
AF031040	85020064 	<b>Feed Roller</b> Tire Only	4851, 4860, 4870, D 485, D 555, D 570, D 4105, D 5505, D 8505, D 10505	<i>Priced per Tire, sold in Bags of 3.</i>
AF032040	85021389 	<b>Separation Roller</b> Tire Only	4851, 4860, 4870, D 485, D 555, D 570, D 4105, D 5505, D 8505, D 10505	<i>Priced per Tire, sold in Bags of 3.</i>
AF030041	85020064 	<b>Bypass Pickup Roller</b> Tire Only	4851, 4860, 4870, D 485, D 555, D 570, D 4105, D 5505, RT- 42	<i>Priced per Tire, sold in Bags of 3.</i>
AF031041	85020064 	<b>Bypass Paper Feed Roller</b> Tire Only	4851, 4860, 4870, D 485, D 555, D 570, D 4105, D 5505, RT- 42	<i>Priced per Tire, sold in Bags of 3.</i>
AF032041	85021389 	<b>Bypass Lower Separation Roller</b> Tire Only	4851, 4860, 4870, D 485, D 555, D 570, D 4105, D 5505, RT- 42	<i>Priced per Tire, sold in Bags of 3.</i>
52162844	85010227 	<b>Friction Pad</b> Cork Type "Pad only"	5115, 5115 RE, 5130, 5131, 6115, 7125, 7125 II, 7125 S, 7130, 8115	<i>Priced per Friction Pad, sold in Bags of 10.</i>
AF033003	85010227 	<b>Friction Pad</b> Cork Type "Pad only"	5130, 5131, 7125, 7125 II, 7130, 7140, D 209, DU- 140, DU- 513, DU- 4050, DU- 7130	<i>Priced per Friction Pad, sold in Bags of 10.</i>
AF031002	85010496 	<b>Paper Feed Roller</b> Tire Only	7120	<i>Priced per Tire, sold in Bags of 10.</i>
AF030035	85018482 	<b>Paper Pickup Roller</b> Tire Only	CS 506, CS 525, D 435, D 435 s, D 445, PS- 360, PS- 380, PS- 390, PS- 420, PS- 500	<i>Priced per Tire, sold in Bags of 10.</i>
AF030031	85016930 	<b>LCT Bypass Pickup Roller</b> Tire Only	CS 510, CS 510 E, CS 513 d, D 440, D 3640, D 4850	<i>Priced per Tire, sold in Bags of 10.</i>
AF031031	85016931 	<b>LCT Bypass Feed Roller</b> Tire Only	CS 510, CS 510 E, CS 513 d, D 440, D 3640, D 4850	<i>Priced per Tire, sold in Bags of 10.</i>









OEM PN	KATUN PN	DESCRIPTION	MODEL NO.	
<b>Feed/Delivery</b>				
AF032031	85016932 	<b>LCT Bypass Separation Roller</b> Tire Only	CS 510, CS 510 E, CS 513 d, D 440, D 3640, D 4850	<i>Priced per Tire, sold in Bags of 10.</i>
AF031012	85010496 	<b>Paper Feed Roller</b> Tire Only	D 431, DIG LCT- 1, DIG LCT- D	<i>Priced per Tire, sold in Bags of 10.</i>
A6801241	85017521 	<b>Paper Feed Belt</b>	D 435, D 435 s, D 445, D 455, D 465, D 555, D 570, DF- 67	
A8061321	85017775 	<b>Paper Pickup Roller</b> Tire Only	D 455, D 465, D 485, D 555, D 570, D 4105, D 5505, D 6005, D 7505, D 8505, D 10505	<i>Priced per Tire, sold in Bags of 10.</i>
AF013005	85019799 	<b>Bottom Plate Friction Pad</b> Cork Type	D 455, D 465, D 485, D 555, D 570, D 4105, D 5505, D 6005, D 7505, D 8505, D 10505	<i>Priced per Friction Pad, sold in Bags of 10.</i>
A8061295	85017521 	<b>Paper Feed Belt</b>	D 455, D 465, D 485, D 555, D 570, D 4105, D 5505, D 6005, D 7505, D 8505, D 10505, DF- 67	
A6801671	85022888 	<b>Separation Roller</b> Tire Only	D 455, D 465, D 485, D 555, D 570, D 4105, D 8505, D 10505, DF- 67	<i>Priced per Tire, sold in Bags of 10.</i>
A4971170	85015219 	<b>Friction Belt</b> Old Style	ADF- D 209, F- 321, F- 811, RF I- 120, RF- 3	<i>Priced per Belt, sold in Bags of 10.</i>
A4221358	85013062 	<b>Friction Belt</b>	ADF- D 209, F- 811, RF I- 120, RF- 3020	
A3761445	85014409 	<b>Original Feed Roller</b> Tire Only	CRF- 55	<i>Priced per Tire, sold in Bags of 10.</i>
A3762096	85018496 	<b>Belt Pressure Roller</b>	CRF- 55	
A3769502	85011796 	<b>Separation Belt</b>	CRF- 55	<i>Priced per Package, 4 Belts per Package.</i>
A6281241	85018137 	<b>Original Pickup Roller</b> Tire Only	DF- 43, DF- 65	<i>Priced per Tire, sold in Bags of 10.</i>
A5481271	85014387 	<b>Separation Roller</b> Tire Only	DF- 64	<i>Priced per Tire, sold in Bags of 10.</i>
A5481276	85022258 	<b>Original Separation Belt</b>	DF- 64	
A5481461	85023146 	<b>Belt Pressure Roller</b>	DF- 67	

For use in  
**Nashuatec**  
 Copiers

**Central/Eastern Europe**  
 Telephone: 31(0)183-696969  
 Fax: 31(0)183-629055  
 E-mail: order@edc.katun.com



















OEM PN	KATUN PN	DESCRIPTION	MODEL NO.
<b>Feed/Delivery</b>			
A6801851	85020160 	<b>Original Pickup Roller</b> Tire Only	DF- 67  <i>Priced per Tire, sold in Bags of 10.</i>
A8592141	85022885 	<b>Paper Feed Belt</b>	DF- 68, DF- 69, DF- 71, DF- 72
B3512126	85023390 	<b>Paper Pickup Roller</b>	DF- 70
58942171	85010969 	<b>Original Feed Roller</b>	F- 140, F- 456, F- 513, RF- II
AF031056	85016894 	<b>Paper Feed Roller</b> Tire Only Ribbed Tire	PS- 330  <i>Priced per Tire, sold in Bags of 4.</i>
65707030	85015298 	<b>Original Pickup Roller</b> Tire Only	RADF, RADF- 5, RADF- 6  <i>Priced per Roller, sold in Bags of 10.</i>
65707050	85013139 	<b>Original Feed Roller</b> Tire Only	RADF, RADF- 5, RADF- 6  <i>Priced per Tire, sold in Bags of 10.</i>
A4971155	85012386 	<b>Friction Belt</b>	RF- 3



OEM PN	KATUN PN	DESCRIPTION	MODEL NO.
<b>Filters</b>			
AA010072	85014795 	<b>Ozone Filter</b>	3018, 3115, 3120, 3213, 3213 L, 3213 S, 3222, 3320, 3322, 3413, 3413 S, 3415
AA010015	85010194 	<b>Ozone Filter</b>	3213, 3213 L, 3213 S, 3320, 3322, 5115, 5115 RE, 8115
A2043080	85019159 	<b>Developer Filter</b>	3522, 3522 td, 3527, 3527 t, 3527 td, 3535, 3535 t, 3535 td, 3632, 3640, 3722, 3722 td, 3732, 3732 td, 3740, 3740 t, 3740 td
AA012059	85017778 	<b>Dust Filter</b>	4345, 4355, 4365
A0962103	85014453 	<b>Ozone Filter</b> Filter Only without Case	4345, 4355, 4365, 4651, 4660, 4670, 4851, 4860, 4870
AA012060	85014739 	<b>Developer Filter</b>	4345, 4355, 4365, 4651, 4660, 4670, 4851, 4860, 4870, D 455, D 465, D 485, D 555, D 570, D 4105, D 5505, D 6005, D 7505, D 8505, D 10505
AA012079	85019199 	<b>Dust Filter</b>	D 440, D 3640, D 4850
A2291104	85021435 	<b>Ozone Filter</b>	D 455, D 465
A2291262	85020920 	<b>Optics Dust Filter</b>	D 455, D 465, D 555, D 570
AA012113	85020164 	<b>Pressure Release Filter</b> Center	D 485, D 4105, D 8505, D 10505
AA012114	85020163 	<b>Pressure Release Filter</b> Front	D 485, D 4105, D 8505, D 10505
A2931104	85020975 	<b>Ozone Filter</b>	D 555, D 570

For use in  
**Nashuatec**  
 Copiers







**Central/Eastern Europe**  
 Telephone: 31(0)183-696969  
 Fax: 31(0)183-629055  
 E-mail: order@edc.katun.com

OEM PN	KATUN PN	DESCRIPTION	MODEL NO.
<b>Fuser Cleaning</b>			
AE042029	85017948 	<b>Fuser Cleaning Roller</b>	2705, CS 506, CS 506 d, CS 506 de, D 422, D 427, D 435, D 435 s, D 445, D 2205, D 2705
AE045001	85147240 	<b>Oil Supply Pad</b>	3035, 3135 D, 3943, 3943 d, 4050, 7150, 7150 C, 7150 D, C 240, C 302
AE042030	85016688 	<b>Fuser Cleaning Roller</b>	3522, 3522 td, 3527, 3527 t, 3527 td, 3535, 3535 t, 3535 td, 3632, 3640, 3722, 3722 td, 3732, 3732 td, 3740, 3740 t, 3740 td, D 4850
AE040007	85011584 	<b>Oil Supply Roller FIBRA™ II</b> Enhanced fuser cleaning efficiency.	4280, 4280 rdh, 4580 rdh, 4582
78620240	85011977 	<b>Oil Roller</b>	4285, 4592
78620250	85011979 	<b>Fuser Cleaning Roller</b>	4285, 4592
A0974261	85016392 	<b>Lower Fuser Cleaning Roller Assembly</b>	4345, 4355
AE040006	85012652 	<b>Oil Supply Roller</b>	4345, 4355
AE042023	85016068 	<b>Lower Fuser Cleaning Roller</b>	4345, 4355, 4365, 4651, 4660, 4670, 4851, 4860, 4870, D 455, D 465
AE042036	85016068 	<b>Lower Fuser Cleaning Roller</b>	4345, 4355, 4365, 4651, 4660, 4670, 4851, 4860, 4870, D 465, D 555, D 570, D 5505
A2294090	85016392 	<b>Lower Fuser Cleaning Roller Assembly</b>	4345, 4365, 4651, 4660, 4670, D 455, D 465
AE042007	85016347 	<b>Upper Fuser Cleaning Roller</b>	4365
61720421	85011975 	<b>Upper Fuser Cleaning Roller FIBRA™ II</b> Extended fuser component life.	4460
61720431	85017828 	<b>Lower Fuser Cleaning Roller</b>	4460, 4680
61720501	85011974 	<b>Oil Roller</b>	4460, 4680
AE042020	85016315 	<b>Oil Supply Cleaning Roller</b>	4651, 4660, 4670, 4851, 4860, 4870, D 455, D 465
AE042035	85016315 	<b>Oil Supply Cleaning Roller</b>	4651, 4660, 4670, 4851, 4860, 4870, D 455, D 465, D 555, D 570, D 5505
68320330	85015512 	<b>Upper Fuser Cleaning Roller</b>	4680
52154130	85147239 	<b>Oil Supply Pad</b>	5130, 5131, 7125, 7125 II, 7125 S, 7130, 7140, D 209, D 431



Katun Performance Product

© 2004 Katun Corporation

OEM PN	KATUN PN	DESCRIPTION	MODEL NO.
<b>Fuser Cleaning</b>			
A2594080	85018467 	Oil Supply Pad	CS 506, CS 506 d, CS 506 de
AE042009	85016076 	Fuser Cleaning Roller	D 420, D 425, D 440, D 3640
AE045031	85019624 	Oil Supply Roller	D 485, D 4105
AE040039	85023032 	Oil Supply Cleaning Roller	D 485, D 4105, D 8505, D 10505
AE042042	85018610 	Lower Fuser Cleaning Roller	D 485, D 4105, D 8505, D 10505
AE042052	85023605 	Lower Fuser Cleaning Roller	D 6005, D 7505
AE045047	85023288 	Cleaning Web	D 8505, D 10505



For use in  
**Nashuatec**  
 Copiers

**Central/Eastern Europe**  
 Telephone: 31(0)183-696969  
 Fax: 31(0)183-629055  
 E-mail: order@edc.katun.com

OEM PN	KATUN PN	DESCRIPTION	MODEL NO.
--------	----------	-------------	-----------

### Fuser Oil

A2579550	85022278 	<b>Silicone Fuser Oil</b> 1000 ml / Bottle	3035, 3135 D, 3943, 3943 d, 4050, 4100, 4110, 4115, 4172, 4300, 4310, 4325 z, 4510 z, 4550 z, 4790 MK1, 4790 MK2, 4965, 5115, 5115 RE, 5120, 5130, 5131, 6115, 6160, 7112, 7120, 7125, 7125 II, 7125 S, 7130, 7140, 7150, 7150 C, 7150 D, 8115, 37105, 53101, C 240, C 302, C 315, C 406, C 503, C 503 D, C 503 De, C 606, C 606 E, CS 506, CS 506 d, CS 506 de, CS 510, CS 510 E, CS 513 d, CS 525, CS 531, D 209, D 431
----------	---	---	---

*Priced per Bottle, sold in Boxes of 6.*



Central/Eastern Europe  
Telephone: 31(0)183-696969  
Fax: 31(0)183-629055  
E-mail: order@edc.katun.com

For use in  
**Nashuatec**  
Copiers





OEM PN	KATUN PN	DESCRIPTION	MODEL NO.
-----------	-------------	-------------	--------------

## Gears



N/P/N	85021727 	<b>Drum Unit Gear Kit</b> Kit Contains: <ul style="list-style-type: none"><li>• (3) Plastic Idler Gear</li><li>• (1) Plastic Drive Gear</li><li>• (1) Metal Gear w/Plastic Insert</li><li>• (1) Important Product Information</li></ul>	2705, D 422, D 427, D 2205, D 2705
-------	---	--	------------------------------------

For use in  
**Nashuatec**  
 Copiers



**Central/Eastern Europe**  
 Telephone: 31(0)183-696969  
 Fax: 31(0)183-629055  
 E-mail: order@edc.katun.com

OEM PN	KATUN PN	DESCRIPTION	MODEL NO.
<b>Kits</b>			
N/P/N	85022268 	<b>Photoconductor Unit Rebuild Kit</b> Kit Contains: <ul style="list-style-type: none"> <li>• (1) OPC Drum</li> <li>• (1) Drum Cleaning Blade</li> <li>• (1) Reusable Squeeze Bottle</li> <li>• (1) Drum Unit Gear Kit</li> </ul> 1 OPC Kit per Master Carton	2705, D 2205, D 2705, D 3205  <i>Priced per OPC Kit, sold per OPC Kit.</i>
N/P/N	85011126 	<b>Feed Tire Replacement Kit</b> Tire Only Kit Contains: <ul style="list-style-type: none"> <li>• (1) Paper Feed Tire</li> <li>• (1) Separation Tire</li> <li>• (1) Paper Pickup Tire</li> </ul>	3035, 3135 D, 3943, 3943 d, 4050, 4100, 4110, 4115, 4510 z, 4550 z, 7112, 7150, 7150 C, 7150 D, C 240, C 315, CB- 150, EU- C 302, RT- 36
N/P/N <i>Final Inventory</i>	85632570 	<b>Convenience Kit</b> Kit Contains: <ul style="list-style-type: none"> <li>• (1) Oil Supply Pad</li> <li>• (1) Drum Cleaning Brush</li> <li>• (1) Drum Cleaning Blade</li> <li>• (2) Corona Wire Separation</li> <li>• (1) Corona Wire Charge</li> <li>• (2) Corona Wire IDC, ODC, STC, TC</li> <li>• (1) Corona Wire Transfer, Quenching</li> <li>• (2) Paper Feed Tire</li> <li>• (2) Separation Tire</li> <li>• (2) Paper Pickup Tire</li> </ul> Rollers reference above are sold as tires only.	3035, 3135 D, 3943, 3943 d, 7150, 7150 C, 7150 D
N/P/N	85015982 	<b>Fuser Rebuild Kit</b> Kit Contains: <ul style="list-style-type: none"> <li>• (2) Upper Fuser Roller Bushing</li> <li>• (1) Upper Fuser Roller TRITON™ II</li> <li>• (1) Lower Pressure Roller MICROSLEEVE™</li> <li>• (6) Fuser Picker Finger</li> <li>• (1) Fuser Roller Cleaning Blade</li> </ul>	3118, 3515, 3523, 3618, 3916, 3916 D, 3916 L, 3916 R, 3916 S
N/P/N	85020136 	<b>Paper Feed Roller Kit</b> Tire Only For KD 1010 Kit Contains: <ul style="list-style-type: none"> <li>• (1) Paper Pickup Tire</li> <li>• (1) Separation/Feed Tire</li> <li>• (1) Paper Feed Tire</li> </ul>	3525, 4525, CS 506, CS 525, D 435, D 435 s, D 445, D 3525, PS- 360, PS- 380, PS- 390, PS- 420



















OEM PN	KATUN PN	DESCRIPTION	MODEL NO.
<b>Kits</b>			
N/P/N	85018841 	<b>120K PM Kit</b> Without the Cleaning Kit Kit Contains: <ul style="list-style-type: none"> <li>• (1) Paper Pickup Tire</li> <li>• (1) Corona Wire</li> <li>• (4) Separation Belt</li> <li>• (1) Paper Feed Tire</li> <li>• (3) Separation Tire</li> <li>• (1) Paper Pickup Tire</li> <li>• (1) Drum Cleaning Blade</li> <li>• (1) Charge Corona Grid</li> <li>• (1) Duplex Separation Tire</li> <li>• (3) Duplex Separation Belt</li> <li>• (1) Ozone Filter</li> <li>• (1) Developer Filter</li> <li>• (1) Lower Fuser Cleaning Roller</li> <li>• (1) Upper Fuser Cleaning Roller</li> <li>• (1) Fuser Cleaning Roller</li> <li>• (1) Transfer Belt Cleaning Blade</li> <li>• (1) Corona Wire Cleaner</li> <li>• (1) Oil Supply Roller</li> </ul>	4365
PMA175120K	85017605 	<b>120K PM Kit</b> Kit Contains: <ul style="list-style-type: none"> <li>• (1) Corona Wire</li> <li>• (3) Paper Feed Tire</li> <li>• (3) Separation Tire</li> <li>• (3) Paper Pickup Tire</li> <li>• (1) Drum Cleaning Blade</li> <li>• (1) Charge Corona Grid</li> <li>• (1) Duplex Separation Tire</li> <li>• (3) Duplex Separation Belt</li> <li>• (1) Developer Filter</li> <li>• (1) Lower Fuser Cleaning Roller</li> <li>• (1) Oil Supply Cleaning Roller</li> <li>• (1) Belt Cleaning Blade</li> <li>• (1) Cleaning Kit</li> <li>• (1) Oil Supply Roller</li> <li>• (1) Oil Supply Cleaning Blade</li> </ul>	4651, 4660, 4670







OEM PN	KATUN PN	DESCRIPTION	MODEL NO.
<b>Kits</b>			
N/P/N	85021208 	<b>150K PM Kit</b> Without the Cleaning Kit Kit Contains: <ul style="list-style-type: none"> <li>• (1) Lower Pressure Roller</li> <li>• (1) Drum Cleaning Blade Assembly</li> <li>• (1) Upper Fuser Roller</li> <li>• (1) Transfer Belt</li> <li>• (1) Transfer Belt Cleaning Blade</li> <li>• (1) Cleaning Pad</li> <li>• (1) Charge Roller</li> <li>• (2) Drum Picker Finger</li> <li>• (5) Picker Finger</li> </ul>	D 435, D 435 s, D 445
N/P/N	85018842 	<b>120K PM Kit</b> Without the Cleaning Kit Kit Contains: <ul style="list-style-type: none"> <li>• (1) Friction Pad B</li> <li>• (1) Charge Corona Grid</li> <li>• (1) Drum Cleaning Blade</li> <li>• (1) Belt Cleaning Blade</li> <li>• (1) Friction Pad</li> <li>• (1) Corona Wire</li> <li>• (1) Upper Fuser Roller</li> <li>• (2) Heat Insulating Sleeve</li> <li>• (1) Duplex Friction Pad</li> <li>• (1) Bottom Plate Friction Pad</li> <li>• (1) Paper Feed Roller</li> </ul>	D 440, D 3640, D 4850
PMA292300K	85021647 	<b>300K PM Kit</b> Kit Contains: <ul style="list-style-type: none"> <li>• (1) Corona Wire</li> <li>• (1) Drum Cleaning Blade</li> <li>• (1) Charge Corona Grid</li> <li>• (1) Upper Picker Finger</li> <li>• (2) Drum Picker Finger</li> <li>• (1) Cleaning Kit</li> <li>• (1) Corona Wire Cleaner</li> <li>• (1) Upper Fuser Roller</li> <li>• (8) Paper Pickup Roller</li> <li>• (1) Optics Dust Filter</li> <li>• (1) Ozone Filter</li> <li>• (1) Ozone Filter</li> <li>• (4) Separation Roller</li> <li>• (1) Drum Cleaning Brush</li> <li>• (1) Paper Feed Tire</li> <li>• (1) Paper Feed Roller</li> <li>• (1) Paper Pickup Roller</li> </ul>	D 555, D 570

For use in  
**Nashuatec**  
 Copiers

**Central/Eastern Europe**  
 Telephone: 31(0)183-696969  
 Fax: 31(0)183-629055  
 E-mail: order@edc.katun.com

OEM PN	KATUN PN	DESCRIPTION	MODEL NO.
<b>Lamps</b>			
AX520005	85021195 	<b>Exposure Lamp</b> 85V 160W	3035, 3135 D, 3943, 3943 d, 4050, 7150, 7150 C, 7150 D
60120250	85021091 	<b>Heater Lamp</b> 240V 1145W	3114, 3114 L
60168020	85021159 	<b>Exposure Lamp</b> 170V 280W	3114, 3114 L
75768150	85021083 	<b>Heater Lamp</b> 220V 850W	3118, 3417, 3916, 3916 D, 3916 L, 3916 R
75768030	85021155 	<b>Exposure Lamp</b> 170V 350W	3118, 3515, 3530, 3916, 3916 D, 3916 L, 3916 R, 3916 S
AX440049	85021085 	<b>Heater Lamp</b> 220V 830W	3133, 3133 L, 3133 LD
AX520024	85021219 	<b>Exposure Lamp</b> 180V 280W	3413, 3413 S, 3713, 3713 S
67368120	85021165 	<b>Exposure Lamp</b> 170V 350W	3417, 3523, 3540, 3618
AX440150	85022854 	<b>Heater Lamp</b> 230V 650W	3525, 4525, D 3525
AX520025	85021163 	<b>Exposure Lamp</b> 85V 280W	3535, 3535 t, 3535 td
54425752	85021111 	<b>Heater Lamp</b> 240V 960W	4300, 4310, 4325 z, 4510 z, 4550 z, 5115, 5115 RE, 6115, 8115
52059507	85021111 	<b>Heater Lamp</b> 240V 960W	4300, 4310, 4325 z, 4510 z, 4550 z, 5115, 5115 RE, 8115
AX520018	85021124 	<b>Exposure Lamp</b> 180V 280W	4345, 4355
AX440014	85021084 	<b>Heater Lamp</b> 220V 850W	7112
73968030	85021200 	<b>Exposure Lamp</b> 170V 270W	8112
29912040	85021186 	<b>Exposure Lamp</b> 170V 400W	8112 RE
AX440164	85022826 	<b>Heater Lamp</b> 230V 550W	D 6005, D 7505



OEM PN	KATUN PN	DESCRIPTION	MODEL NO.
<b>Memory Upgrades</b>			
000828MIU	85020026 	<b>Memory Upgrade Board- 32 MB</b> Printer Memory Upgrade	1505, 1805, 1805 D, 2705, D 415 S, D 418, D 1305, D 1305 F, D 2205, D 2705
000829MIU	85020027 	<b>Memory Upgrade Board- 64 MB</b> Printer Memory Upgrade	1505, 1805, 1805 D, 2705, D 415 S, D 418, D 1305, D 1305 F, D 2205, D 2705, DSc 38 +
410278	85018425 	<b>Memory Upgrade Board- 48 MB</b> Copier Memory Equivalent to Type 185	D 415 S, D 418, D 422, D 427
A2309352	85021045 	<b>Memory Upgrade Board- 4 MB</b> Flash MemoryField Service Card	D 418, D 422, D 427, D 435, D 435 s, D 445, D 465, D 485, D 555, D 570, D 4105
947MIU	85020031 	<b>Memory Upgrade Board- 32 MB</b> Printer Memory Upgrade	D 485, D 555, D 570, D 4105

For current memory upgrade pricing, visit our on-line catalogue at [www.katun.com](http://www.katun.com) or contact your customer service representative.

For use in  
**Nashuatec**  
Copiers



**Central/Eastern Europe**  
Telephone: 31(0)183-696969  
Fax: 31(0)183-629055  
E-mail: [order@edc.katun.com](mailto:order@edc.katun.com)

OEM PN	KATUN PN	DESCRIPTION	MODEL NO.
-----------	-------------	-------------	--------------

---

**Miscellaneous**

---









AX200107	85022980 	<b>Magnetic Clutch</b>	3522, 3522 td, 3527, 3527 td, 3535, 3535 td, 3722, 3722 td
AX210037	85021484 	<b>Magnetic Clutch</b>	4345, 4355, 4365, 4651, 4660, 4670, C 606, C 606 E











OEM PN	KATUN PN	DESCRIPTION	MODEL NO.	
<b>Photoreceptors</b>				
B0399510	85021670 	<b>OPC Drum</b> 50 Drums per Master Carton	1505, 1805, 1805 D, DSM 615, DSM 618, DSM 618 D	<i>Priced per Drum, sold per Drum.</i>
411018	85023193	<b>OPC Drum Unit Original</b>	2705, D 2205, D 2705, D 3205	
N/P/N	85022268 	<b>Photoconductor Unit Rebuild Kit</b> Kit Contains: • (1) OPC Drum • (1) Drum Cleaning Blade • (1) Reusable Squeeze Bottle • (1) Drum Unit Gear Kit 1 OPC Kit per Master Carton	2705, D 2205, D 2705, D 3205	<i>Priced per OPC Kit, sold per OPC Kit.</i>
A0069510	85018646 	<b>OPC Drum</b> Drum reduces noise in selected applications. 12 Drums per Master Carton	3018, 3115, 3120, 3222, 7120	<i>Priced per Drum, sold per Drum.</i>
A0069510	85014312 	<b>OPC Drum</b> This drum is packaged for use in Ricoh, but is approved for use in this Nashuatec model. 12 Drums per Master Carton	3018, 3115, 3120, 3222, 7120	<i>Priced per Drum, sold per Drum.</i>
A0069510	85012054 	<b>OPC Drum</b> This drum is packaged for use in Nashuatec/Savin. 12 Drums per Master Carton	3018, 3115, 3120, 3222, 7120	<i>Priced per Drum, sold per Drum.</i>
A0069510	85017128	<b>OPC Drum Access By Katun</b> 12 Drums per Master Carton	3018, 3115, 3120, 3222, 7120	<i>Priced per Drum, sold per Drum.</i>
A0069510	85014313	<b>OPC Drum Access By Katun</b> 12 Drums per Master Carton	3018, 3115, 3120, 3222, 7120	<i>Priced per Drum, sold per Drum.</i>
52059510	85502701 	<b>As2Se3 Drum</b> Tighter electrical tolerance and higher surface quality. 6 Drums per Master Carton	3035, 3135 D, 3943, 3943 d, 4050, 4300, 4310, 4325 z, 4510 z, 4550 z, 5130, 5131, 7125, 7125 II, 7125 S, 7130, 7140, 7150, 7150 C, 7150 D	<i>Priced per Drum, sold per Drum.</i>
52059510 <i>Final Inventory</i>	85017480 	<b>As2Se3 Drum</b> 6 Drums per Master Carton	3035, 3135 D, 3943, 3943 d, 4050, 4300, 4310, 4325 z, 4510 z, 4550 z, 5130, 5131, 7125, 7125 II, 7125 S, 7130, 7140, 7150, 7150 C, 7150 D	<i>Priced per Drum, sold per Drum.</i>
52059510	85505335	<b>As2Se3 Drum Access By Katun</b> 6 Drums per Master Carton	3035, 3135 D, 3943, 3943 d, 4050, 4300, 4310, 4325 z, 4510 z, 4550 z, 5130, 5131, 7125, 7125 II, 7125 S, 7130, 7140, 7150, 7150 C, 7150 D	<i>Priced per Drum, sold per Drum.</i>
83120500	85503141 	<b>SeTe Drum</b> 6 Drums per Master Carton	3114, 3114 L, 8112, 8112 RE	<i>Priced per Drum, sold per Drum.</i>

For use in  
**Nashuatec**  
 Copiers







**Central/Eastern Europe**  
 Telephone: 31(0)183-696969  
 Fax: 31(0)183-629055  
 E-mail: order@edc.katun.com

OEM PN	KATUN PN	DESCRIPTION	MODEL NO.	
<b>Photoreceptors</b>				
67382500	85000925 	<b>OPC Drum</b> 12 Drums per Master Carton	3118, 3515, 3530, 3540, 3916, 3916 D, 3916 L, 3916 R, 3916 S	<i>Priced per Drum, sold per Drum.</i>
75782062	85000925 	<b>OPC Drum</b> 12 Drums per Master Carton	3118, 3515, 3530, 3540, 3916, 3916 D, 3916 L, 3916 R, 3916 S	<i>Priced per Drum, sold per Drum.</i>
2300033	85018646 	<b>OPC Drum</b> Drum reduces noise in selected applications. 12 Drums per Master Carton	3133, 3133 L, 3133 LD, 3227, 3227 L, 3227 LD, 3320, 3322, 3322 S, 3415	<i>Priced per Drum, sold per Drum.</i>
2300033	85012054 	<b>OPC Drum</b> This drum is packaged for use in Nashuatec/Savin. 12 Drums per Master Carton	3133, 3133 L, 3133 LD, 3227, 3227 L, 3227 LD, 3320, 3322, 3322 S, 3415	<i>Priced per Drum, sold per Drum.</i>
2300033	85014312 	<b>OPC Drum</b> This drum is packaged for use in Ricoh, but is approved for use in this Nashuatec model. 12 Drums per Master Carton	3133, 3133 L, 3133 LD, 3227, 3227 L, 3227 LD, 3320, 3322, 3322 S, 3415	<i>Priced per Drum, sold per Drum.</i>
2300033	85013636	<b>OPC Drum Original</b>	3133, 3133 L, 3133 LD, 3227, 3227 L, 3227 LD, 3320, 3322, 3322 S, 3415	
2300033	85017128	<b>OPC Drum Access By Katun</b> 12 Drums per Master Carton	3133, 3133 L, 3133 LD, 3227, 3227 L, 3227 LD, 3320, 3322, 3322 S, 3415	<i>Priced per Drum, sold per Drum.</i>
2300033	85014313	<b>OPC Drum Access By Katun</b> 12 Drums per Master Carton	3133, 3133 L, 3133 LD, 3227, 3227 L, 3227 LD, 3320, 3322, 3322 S, 3415	<i>Priced per Drum, sold per Drum.</i>
2300013	85010167 	<b>OPC Drum</b> 12 Drums per Master Carton	3213, 3213 L, 3213 S, 3413, 3413 S, 3713, 3713 S	<i>Priced per Drum, sold per Drum.</i>
A2199510	85010167 	<b>OPC Drum</b> 12 Drums per Master Carton	3213, 3213 L, 3213 S, 3413, 3413 S, 3713, 3713 S	<i>Priced per Drum, sold per Drum.</i>
65882020	85013412	<b>OPC Drum Original</b>	3412	
66082010	85016487 	<b>OPC Drum</b> 20 Drums per Master Carton	3417	<i>Priced per Drum, sold per Drum.</i>
2300035	85017029 	<b>OPC Drum</b> 12 Drums per Master Carton	3522, 3522 td, 3527, 3527 t, 3527 td, 3535, 3535 t, 3535 td, 3632, 3640, 3722, 3722 td, 3732, 3732 td, 3740, 3740 t, 3740 td	<i>Priced per Drum, sold per Drum.</i>

OEM PN	KATUN PN	DESCRIPTION	MODEL NO.
<b>Photoreceptors</b>			
2300035	85013358	<b>OPC Drum Original</b>	3522, 3522 td, 3527, 3527 t, 3527 td, 3535, 3535 t, 3535 td, 3632, 3640, 3722, 3722 td, 3732, 3732 td, 3740, 3740 t, 3740 td
66282020	85016487 	<b>OPC Drum</b> 20 Drums per Master Carton	3523, 3618  <i>Priced per Drum, sold per Drum.</i>
A2309510	85019540 	<b>OPC Drum</b> 12 Drums per Master Carton	3525, 4525, D 435, D 435 s, D 445, D 3525  <i>Priced per Drum, sold per Drum.</i>
A2309510	85018457	<b>OPC Drum Original</b>	3525, 4525, D 435, D 435 s, D 445, D 3525
889782	85018463	<b>Imaging Unit Original</b>	3612, 3612 S
2300014	85016406	<b>OPC Drum Original</b>	3715, 3715 +, 3718, 3718 +, 3913, 3913 S
2300014	85015760	<b>OPC Drum Access By Katun</b> 20 Drums per Master Carton	3715, 3715 +, 3718, 3718 +, 3913, 3913 S  <i>Priced per Drum, sold per Drum.</i>
78682010	85009132 	<b>As2Se3 Drum</b> 6 Drums per Master Carton	4285, 4592  <i>Priced per Drum, sold per Drum.</i>
54429510	85502701 	<b>As2Se3 Drum</b> Tighter electrical tolerance and higher surface quality. 6 Drums per Master Carton	4300, 4310, 4325 z, 7125 S  <i>Priced per Drum, sold per Drum.</i>
54429510 <i>Final Inventory</i>	85017480 	<b>As2Se3 Drum</b> 6 Drums per Master Carton	4300, 4310, 4325 z, 7125 S  <i>Priced per Drum, sold per Drum.</i>
54429510	85505335	<b>As2Se3 Drum Access By Katun</b> 6 Drums per Master Carton	4300, 4310, 4325 z, 7125 S  <i>Priced per Drum, sold per Drum.</i>
2300045	85016933 	<b>OPC Drum</b> 12 Drums per Master Carton	4345, 4355, 4365, 4651, 4660, 4670, 4851, 4860, 4870  <i>Priced per Drum, sold per Drum.</i>
A2489510	85016933 	<b>OPC Drum</b> 12 Drums per Master Carton	4345, 4355, 4365, 4651, 4660, 4670, 4851, 4860, 4870  <i>Priced per Drum, sold per Drum.</i>
N/P/N	85503138 	<b>SeTe Drum</b> 6 Drums per Master Carton	8120, 8122, 8122 S  <i>Priced per Drum, sold per Drum.</i>
A1099510	85016439	<b>OPC Drum Original</b> 40 K	C 406
A1669510	85016415	<b>OPC Drum Original</b>	C 503, C 503 D, C 503 De

For use in  
**Nashuatec**  
 Copiers

**Central/Eastern Europe**  
 Telephone: 31(0)183-696969  
 Fax: 31(0)183-629055  
 E-mail: order@edc.katun.com

OEM PN	KATUN PN	DESCRIPTION	MODEL NO.
<b>Photoreceptors</b>			
209911	85015956	<b>OPC Drum Unit Original</b>	D 420
410423	85018458	<b>OPC Drum Unit Original</b>	D 422, D 427
N/P/N	85022264 	<b>Photoconductor Unit Rebuild Kit</b> Kit Contains: <ul style="list-style-type: none"> <li>• (1) OPC Drum</li> <li>• (1) Drum Cleaning Blade</li> <li>• (1) Drum Unit Gear Kit</li> <li>• (1) Black Developer</li> </ul> 1 OPC Kit per Master Carton	D 422, D 427
N/P/N	85023020 	<b>Photoconductor Unit Rebuild Kit</b> Kit Contains: <ul style="list-style-type: none"> <li>• (1) OPC Drum</li> <li>• (1) Drum Cleaning Blade</li> </ul> 1 OPC Kit per Master Carton	D 422, D 427
209890	85016414	<b>OPC Drum Unit Original</b>	D 425
2300640	85019726 	<b>OPC Drum</b> 6 Drums per Master Carton	D 440, D 3640, D 4850
A1339510	85019726 	<b>OPC Drum</b> 6 Drums per Master Carton	D 440, D 3640, D 4850
A2949510	85018281 	<b>OPC Drum</b> 6 Drums per Master Carton	D 455, D 465, D 485, D 555, D 570, D 4105, D 5505, D 8505, D 10505
B0649510	85018281 	<b>OPC Drum</b> 6 Drums per Master Carton	D 6005, D 7505

*Priced per OPC Kit, sold per OPC Kit.*

*Priced per OPC Kit, sold per OPC Kit.*



*Priced per Drum, sold per Drum.*

*Priced per Drum, sold per Drum.*

*Priced per Drum, sold per Drum.*





*Priced per Drum, sold per Drum.*







OEM PN	KATUN PN	DESCRIPTION	MODEL NO.	
<b>Picker Fingers</b>				
A7150079	85013182 	<b>Picker Finger</b>	2407	<i>Priced per Picker Finger, sold in Bags of 10.</i>
A0069002	85012822 	<b>Picker Finger</b>	3018, 3115, 3120, 3133, 3133 L, 3133 LD, 3222, 3227, 3227 L, 3227 LD, 3320, 3322, 3415, 7120	<i>Priced per Set, 5 Picker Fingers per Set.</i>
A0079005	85242357 	<b>Picker Finger</b>	3035, 3135 D, 3943, 3943 d, 4050, 7150, 7150 C, 7150 D	<i>Priced per Set, 6 Picker Fingers per Set.</i>
28120470	85013100 	<b>Picker Finger</b>	3118, 3417, 3515, 3523, 3530, 3618, 3916, 3916 D, 3916 L, 3916 R, 3916 S	<i>Priced per Picker Finger, sold in Packages of 10.</i>
AD025019	85015662 	<b>Drum Picker Finger</b>	3522, 3522 td, 3527, 3527 t, 3527 td, 3535, 3535 t, 3535 td, 3632, 3640, 3722, 3722 td, 3732, 3732 td, 3740, 3740 t, 3740 td	<i>Priced per Picker Finger, sold in Bags of 6.</i>
AE044019	85015257 	<b>Upper Picker Finger</b>	3522, 3522 td, 3527, 3527 t, 3527 td, 3535, 3535 t, 3535 td, 3632, 3640, 3722, 3722 td, 3732, 3732 td, 3740, 3740 t, 3740 td, 4851, 4860, 4870, D 440, D 555, D 570, D 3640, D 4850	<i>Priced per Set, 5 Picker Fingers per Set.</i>
AD025021	85018635 	<b>Drum Picker Finger</b>	3525, 4525, D 435, D 435 s, D 445, D 3525	<i>Priced per Picker Finger, sold in Boxes of 6.</i>
61720750	85014643 	<b>Upper Picker Finger B</b>	3540, 4460, 4680	<i>Priced per Picker Finger, sold in Packages of 7.</i>
78620520	85015661 	<b>Lower Picker Finger</b>	4285, 4460, 4592, 4680	<i>Priced per Picker Finger, sold in Bags of 10.</i>
54429006	85012859 	<b>Upper Picker Finger</b>	4300, 4310, 4325 z, 4510 z, 4550 z, 5120	<i>Priced per Set, 6 Picker Fingers per Set.</i>
AD025018	85015660 	<b>Drum Picker Finger</b>	4345, 4355, 4365, 4651, 4660, 4670, 4851, 4860, 4870, D 455, D 465	<i>Priced per Picker Finger, sold in Packages of 6.</i>
A0969500	85015257 	<b>Upper Picker Finger</b>	4345, 4355, 4365, 4651, 4660, 4670, D 455, D 465	<i>Priced per Set, 5 Picker Fingers per Set.</i>
52159002	85012859 	<b>Upper Picker Finger</b>	5130, 5131, 7125, 7125 II, 7125 S, 7130	<i>Priced per Set, 6 Picker Fingers per Set.</i>
29820380	85014608 	<b>Picker Finger</b>	8112, 8112 RE	<i>Priced per Picker Finger, sold in Packages of 6.</i>

For use in  
**Nashuatec**  
 Copiers

**Central/Eastern Europe**  
 Telephone: 31(0)183-696969  
 Fax: 31(0)183-629055  
 E-mail: order@edc.katun.com















OEM PN	KATUN PN	DESCRIPTION	MODEL NO.	
<b>Picker Fingers</b>				
42528100	85013100 	<b>Picker Finger</b>	8120, 8122, 8122 S	<i>Priced per Picker Finger, sold in Packages of 10.</i>
AE044022	85017588 	<b>Picker Finger</b>	D 435, D 435 s, D 445	<i>Priced per Picker Finger, sold in Boxes of 5.</i>
AE044028	85017588 	<b>Upper Picker Finger</b>	D 435, D 435 s, D 445	<i>Priced per Picker Finger, sold in Boxes of 5.</i>
AD025020	85015660 	<b>Drum Picker Finger</b>	D 440, D 3640, D 4850	<i>Priced per Picker Finger, sold in Packages of 6.</i>
AD025022	85015660 	<b>Drum Picker Finger</b>	D 485, D 555, D 570, D 4105, D 5505, D 8505, D 10505	<i>Priced per Picker Finger, sold in Packages of 6.</i>

















OEM PN	KATUN PN	DESCRIPTION	MODEL NO.
<b>Rollers, Fuser/Heat</b>			
AE011065	85023852 	<b>Upper Fuser Roller</b> <b>TRITON BLUE™</b>	1505, 1805, 1805 D
AE011058	85023853 	<b>Upper Fuser Roller</b> <b>TRITON BLUE™</b>	2705, D 2205, D 2705
AE011035	85013837 	<b>Upper Fuser Roller</b> <b>TRITON™ II</b> Improved Toner Release Characteristics	3018, 3115, 3120, 3222, 3320, 3322, 3322 S, 3415, 8115
AE011035	85014850	<b>Upper Fuser Roller</b> <b>Access By Katun</b>	3018, 3115, 3120, 3222, 3320, 3322, 3322 S, 3415, 8115
N/P/N	85014363 	<b>Upper Fuser Roller</b> <b>Assembly</b> <b>ALUMANA™</b> Patented TEFLON® coating with reinforcing oxides extends life. Kit Contains: • (1) Upper Fuser Roller • (2) Upper Fuser Roller Bearing • (2) Heat Insulating Sleeve	3035, 3135 D, 3943, 3943 d, 4050, 4300, 4310, 4325 z, 4510 z, 4550 z, 5120, 5130, 5131, 7125, 7130, 7140, 7150, 7150 C, 7150 D, D 209
AE011001	85014362 	<b>Upper Fuser Roller</b> <b>ALUMANA™</b> Patented TEFLON® coating with reinforcing oxides extends life.	3035, 3135 D, 3943, 3943 d, 4050, 7150, 7150 C, 7150 D
AE011001	85014847	<b>Upper Fuser Roller</b> <b>Access By Katun</b>	3035, 3135 D, 3943, 3943 d, 4050, 7150, 7150 C, 7150 D
73920390	85636841 	<b>Upper Fuser Roller</b> <b>DURAPREM™ II</b>	3114, 3114 L, 8112, 8112 RE
73920390	85014842	<b>Upper Fuser Roller</b> <b>Access By Katun</b>	3114, 3114 L, 8112, 8112 RE
65420090	85012578 	<b>Upper Fuser Roller</b> <b>TRITON™ II</b> Improved Toner Release Characteristics	3118, 3515, 3530, 3916, 3916 D, 3916 L, 3916 R, 3916 S, 8120, 8122, 8122 S
65420090	85014841	<b>Upper Fuser Roller</b> <b>Access By Katun</b>	3118, 3515, 3530, 3916, 3916 D, 3916 L, 3916 R, 3916 S, 8120, 8122, 8122 S
AE011002	85010637 	<b>Upper Fuser Roller</b> <b>DURACON™ II</b>	3133, 3133 L, 3133 LD, 3227, 3227 L, 3227 LD, 7120
AE011002	85014848	<b>Upper Fuser Roller</b> <b>Access By Katun</b>	3133, 3133 L, 3133 LD, 3227, 3227 L, 3227 LD, 7120
AE011033	85011994 	<b>Upper Fuser Roller</b> <b>DURACON™ II</b>	3213, 3213 L, 3213 S, 3413, 3413 S, 3713, 3713 S
65820070	85012450 	<b>Upper Fuser Roller</b> OEM Type	3412
66220150	85012578 	<b>Upper Fuser Roller</b> <b>TRITON™ II</b> Improved Toner Release Characteristics	3417, 3523, 3618
66220150	85014841	<b>Upper Fuser Roller</b> <b>Access By Katun</b>	3417, 3523, 3618

For use in  
**Nashuatec**  
 Copiers

**Central/Eastern Europe**  
 Telephone: 31(0)183-696969  
 Fax: 31(0)183-629055  
 E-mail: order@edc.katun.com







OEM PN	KATUN PN	DESCRIPTION	MODEL NO.
<b>Rollers, Fuser/Heat</b>			
AE011024	85019794 	<b>Upper Fuser Roller</b> <b>TRITON™ II</b> Improved Toner Release Characteristics	3522, 3522 td, 3527, 3527 t, 3527 td, 3722, 3722 td
AE011024	85014792	<b>Upper Fuser Roller</b> <b>Access By Katun</b>	3522, 3522 td, 3527, 3527 t, 3527 td, 3722, 3722 td
AE011064	85021945 	<b>Upper Fuser Roller</b> For use only in the models listed	3525, 4525, D 3525
AE011071	85021945 	<b>Upper Fuser Roller</b> For use only in the models listed	3525, 4525, D 3525
AE011027	85019793 	<b>Upper Fuser Roller</b> <b>TRITON™ II</b> Improved Toner Release Characteristics	3535, 3535 t, 3535 td, 3632, 3732, 3732 td
AE011027	85014791	<b>Upper Fuser Roller</b> <b>Access By Katun</b>	3535, 3535 t, 3535 td, 3632, 3732, 3732 td
67320030	85012550 	<b>Upper Fuser Roller</b> <b>DURACON™ II</b>	3540
AE011045	85016079 	<b>Upper Fuser Roller</b> OEM Type	3640, 3740, 3740 td
A2194081	85015920 	<b>Upper Fuser Roller</b> OEM Type	3715
A2984081	85015920 	<b>Upper Fuser Roller</b> OEM Type	3715 +, 3913, 3913 S
A2454100	85015920 	<b>Upper Fuser Roller</b> OEM Type	3718
A2994100	85015920 	<b>Upper Fuser Roller</b> OEM Type	3718 +
AE011032 <i>Final Inventory</i>	85011285 	<b>Upper Fuser Roller</b> <b>ALUMANA™</b> Patented TEFLON® coating with reinforcing oxides extends life.	4280, 4280 rdh
52059004	85014362 	<b>Upper Fuser Roller</b> <b>ALUMANA™</b> Patented TEFLON® coating with reinforcing oxides extends life.	4300, 4310, 4325 z, 4510 z, 4550 z, 5120
52059004	85014847	<b>Upper Fuser Roller</b> <b>Access By Katun</b>	4300, 4310, 4325 z, 4510 z, 4550 z, 5120
AE011042	85012373 	<b>Upper Fuser Roller</b> <b>ALUMANA™</b> Patented TEFLON® coating with reinforcing oxides extends life.	4345, 4355, 4365, 4651, 4660, 4670, 4851, 4860, 4870
AE011042	85014849	<b>Upper Fuser Roller</b> <b>Access By Katun</b>	4345, 4355, 4365, 4651, 4660, 4670, 4851, 4860, 4870
61720411	85012316 	<b>Upper Fuser Roller</b> <b>ALUMANA™</b> Patented TEFLON® coating with reinforcing oxides extends life.	4460





















OEM PN	KATUN PN	DESCRIPTION	MODEL NO.
<b>Rollers, Fuser/Heat</b>			
AE011037 <i>Final Inventory</i>	85011285 	<b>Upper Fuser Roller</b> <b>ALUMANA™</b> Patented TEFLON® coating with reinforcing oxides extends life.	4580 rdh, 4582
68320141	85014751 	<b>Upper Fuser Roller</b> <b>ALUMANA™</b> Patented TEFLON® coating with reinforcing oxides extends life.	4680
AE011003	85014362 	<b>Upper Fuser Roller</b> <b>ALUMANA™</b> Patented TEFLON® coating with reinforcing oxides extends life.	5130, 5131, 7125, 7125 II, 7125 S, 7130, 7140, D 209
AE011003	85014847	<b>Upper Fuser Roller</b> <b>Access By Katun</b>	5130, 5131, 7125, 7125 II, 7125 S, 7130, 7140, D 209
A0179525	85636746 	<b>Upper Fuser Roller</b> <b>DURAPREM™ II</b>	7112
AE010024	85018756 	<b>Upper Fuser Roller</b> Silicone Based	C 503, C 503 D, C 503 De
AE010018	85019178 	<b>Upper Fuser Roller</b> Silicone Based	C 606, C 606 E
AE010035	85018754 	<b>Upper Fuser Roller</b> Silicone Based	CS 506, CS 506 d, CS 506 de
A2504110	85018470 	<b>Upper Fuser Roller</b> <b>TRITON™ II</b>	D 415 S, D 418
A2504111	85018470 	<b>Upper Fuser Roller</b> <b>TRITON™ II</b>	D 415 S, D 418
G0204170	85023404 	<b>Upper Fuser Roller</b> <b>TRITON BLUE™</b>	D 420
G0204170	85015917	<b>Upper Fuser Roller</b> <b>Access By Katun</b>	D 420
AE011048	85018752 	<b>Upper Fuser Roller</b> <b>TRITON™ II</b>	D 422, D 427
A2244170	85017529 	<b>Upper Fuser Roller</b> <b>TRITON™ II</b> Improved Toner Release Characteristics	D 425
A2244170	85015918	<b>Upper Fuser Roller</b> <b>Access By Katun</b>	D 425
AE011041	85017530 	<b>Upper Fuser Roller</b> <b>TRITON™ II</b> Improved Toner Release Characteristics	D 435, D 435 s, D 445
AE011041	85016692	<b>Upper Fuser Roller</b> <b>Access By Katun</b>	D 435, D 435 s, D 445
AE011059	85017530 	<b>Upper Fuser Roller</b> <b>TRITON™ II</b> Improved Toner Release Characteristics	D 435, D 435 s, D 445

For use in  
**Nashuatec**  
 Copiers

**Central/Eastern Europe**  
 Telephone: 31(0)183-696969  
 Fax: 31(0)183-629055  
 E-mail: order@edc.katun.com





















OEM PN	KATUN PN	DESCRIPTION	MODEL NO.
<b>Rollers, Fuser/Heat</b>			
AE011036	85017531 	<b>Upper Fuser Roller</b> <b>TRITON™ II</b> Improved Toner Release Characteristics	D 440, D 3640, D 4850
AE011044	85023107 	<b>Upper Fuser Roller</b> <b>TRITON™ II</b>	D 455, D 465, D 555, D 570
AE011049	85023678 	<b>Upper Fuser Roller</b> <b>TRITON BLUE™</b>	D 485, D 4105
AE011049	85018916	<b>Upper Fuser Roller</b> <b>Access By Katun</b>	D 485, D 4105
AE011056	85023678 	<b>Upper Fuser Roller</b> <b>TRITON BLUE™</b>	D 485, D 4105, D 8505, D 10505
AE011056	85018916	<b>Upper Fuser Roller</b> <b>Access By Katun</b>	D 485, D 4105, D 8505, D 10505
AE011061	85022311 	<b>Upper Fuser Roller</b>	D 1205, D 1305, D 1305 F
AE011069	85023246 	<b>Upper Fuser Roller</b>	D 6005, D 7505



OEM PN	KATUN PN	DESCRIPTION	MODEL NO.
<b>Rollers, Pressure</b>			
AE020100	85022556 	<b>Lower Pressure Roller MICROSLEEVE™</b>	1505, 1805, 1805 D
AE020118	85022955 	<b>Lower Pressure Roller MICROSLEEVE™</b>	2705, D 2205, D 2705
AE020016	85020957 	<b>Lower Pressure Roller MICROSLEEVE™</b>	3018, 3115, 3120, 3222, 3320, 3322, 3322 S, 3415
AE020019	85636838 	<b>Lower Pressure Roller MICROSLEEVE™</b>	3035, 3135 D, 3943, 3943 d, 4050, 7125 II, 7125 S, 7140, 7150, 7150 C, 7150 D, D 209
29820052	85636842 	<b>Lower Pressure Roller</b>	3114, 3114 L, 8112, 8112 RE
75858592	85014104 	<b>Lower Pressure Roller MICROSLEEVE™</b>	3118, 3515, 3523, 3530, 3618, 3916, 3916 D, 3916 L, 3916 R, 3916 S, 8120, 8122, 8122 S
75720122	85011324 	<b>Lower Pressure Roller</b>	3118, 3515, 3523, 3530, 3916, 3916 D, 3916 L, 3916 R, 3916 S, 8120, 8122, 8122 S
AE020030	85021558 	<b>Lower Pressure Roller MICROSLEEVE™</b>	3133, 3133 L, 3133 LD
AE020024	85011075 	<b>Lower Pressure Roller MICROSLEEVE™</b>	3213, 3213 L, 3213 S, 3413, 3413 S, 3713, 3713 S
65820010	85016788 	<b>Lower Pressure Roller</b>	3412
66020100	85013739 	<b>Lower Pressure Roller MICROSLEEVE™</b> PFA Sleeve extends life.	3417
66068450	85013739 	<b>Lower Pressure Roller MICROSLEEVE™</b> PFA Sleeve extends life.	3417
AE020050	85013738 	<b>Lower Pressure Roller MICROSLEEVE™</b>	3522, 3522 td, 3527, 3527 t, 3527 td, 3535, 3535 t, 3535 td, 3632, 3640, 3722, 3722 td, 3732, 3732 td, 3740, 3740 t, 3740 td
AE020108	85021633 	<b>Lower Pressure Roller MICROSLEEVE™</b>	3525, 4525, D 3525
A1904082	85016730 	<b>Lower Pressure Roller</b>	3715
A2984082	85016730 	<b>Lower Pressure Roller</b>	3715 +, 3913, 3913 S
AE020020	85011053 	<b>Lower Pressure Roller MICROSLEEVE™</b>	4172
AE020023	85011053 	<b>Lower Pressure Roller MICROSLEEVE™</b>	4280, 4280 rdh
AE020059	85018873 	<b>Lower Pressure Roller MICROSLEEVE™</b>	4345, 4355, 4365, 4651, 4660, 4670

For use in  
**Nashuatec**  
 Copiers



**Central/Eastern Europe**  
 Telephone: 31(0)183-696969  
 Fax: 31(0)183-629055  
 E-mail: order@edc.katun.com

OEM PN	KATUN PN	DESCRIPTION	MODEL NO.
<b>Rollers, Pressure</b>			
61720450	85020964 	<b>Lower Pressure Roller MICROSLEEVE™</b>	4460
68320190	85020964 	<b>Lower Pressure Roller MICROSLEEVE™</b>	4680
AE020078	85018873 	<b>Lower Pressure Roller MICROSLEEVE™</b>	4851, 4860, 4870
52194621	85011053 	<b>Lower Pressure Roller MICROSLEEVE™</b>	4965, 6160
AE020015	85021557 	<b>Lower Pressure Roller MICROSLEEVE™</b>	5130, 5131, 7125, 7130
AE020006	85010021 	<b>Lower Pressure Roller MICROSLEEVE™</b> PFA Sleeve extends life.	7112
72120031	85014104 	<b>Lower Pressure Roller MICROSLEEVE™</b>	8120, 8122, 8122 S
72120031	85011324 	<b>Lower Pressure Roller</b>	8120, 8122, 8122 S
AE020066	85018755 	<b>Lower Pressure Roller</b> Silicone Based	C 503, C 503 D, C 503 De
AE020088	85019179 	<b>Lower Pressure Roller</b> Silicone Based	C 606, C 606 E
AE020110	85018753 	<b>Lower Pressure Roller</b> Silicone Based	CS 506, CS 506 d, CS 506 de
G0294120	85018515 	<b>Lower Pressure Roller MICROSLEEVE™</b>	D 415 S, D 418
G0204180	85016078 	<b>Lower Pressure Roller MICROSLEEVE™</b>	D 420
AE020086	85019886 	<b>Lower Pressure Roller MICROSLEEVE™</b>	D 422, D 427
G0204280	85016794 	<b>Lower Pressure Roller</b>	D 425
AE020074	85017027 	<b>Lower Pressure Roller MICROSLEEVE™</b>	D 435, D 435 s, D 445
AE020055	85013738 	<b>Lower Pressure Roller MICROSLEEVE™</b>	D 440, D 3640
AE022078	85017593 	<b>Lower Pressure Roller MICROSLEEVE™</b>	D 455, D 465, D 555, D 570, D 5505
AE020087	85019876 	<b>Lower Pressure Roller MICROSLEEVE™</b>	D 485, D 4105
AE020107	85022954 	<b>Lower Pressure Roller MICROSLEEVE™</b>	D 1205, D 1305, D 1305 F







Katun Performance Product

© 2004 Katun Corporation

OEM PN	KATUN PN	DESCRIPTION	MODEL NO.
<b>Rollers, Pressure</b>			
AE020072	85013738 	Lower Pressure Roller MICROSLEEVE™	D 4850
AE020112	85023403 	Lower Pressure Roller MICROSLEEVE™	D 6005, D 7505

For use in  
**Nashuatec**  
 Copiers

**Central/Eastern Europe**  
 Telephone: 31(0)183-696969  
 Fax: 31(0)183-629055  
 E-mail: order@edc.katun.com

OEM PN	KATUN PN	DESCRIPTION	MODEL NO.
<b>Seals</b>			
AA152142	85011640 	V Ring	3035, 3135 D
			<i>Priced per Seal, sold in Bags of 4.</i>
A0079006	85013733 	Cleaning Unit Seal	3035, 3135 D, 3943, 3943 d, 4050, 7150, 7150 C, 7150 D
75768080	85011980 	Cleaning Unit Lower Seal Assembly	3118, 3515, 3916, 3916 D, 3916 L, 3916 R, 3916 S
52193326	85011640 	V Ring	3740 td
			<i>Priced per Seal, sold in Bags of 4.</i>



Central/Eastern Europe  
Telephone: 31(0)183-696969  
Fax: 31(0)183-629055  
E-mail: [order@edc.katun.com](mailto:order@edc.katun.com)

For use in  
**Nashuatec**  
Copiers

OEM PN	KATUN PN	DESCRIPTION	MODEL NO.
-----------	-------------	-------------	--------------

## Springs

72916070	85524654 	<b>Corona Wire Spring</b> Stainless Steel Transfer, Separation Transfer	2310, 8108, 8108 C 3412	<i>Priced per Spring, sold in Bags of 10.</i>
----------	---	--	----------------------------	---

For use in  
**Nashuatec**  
Copiers

**Central/Eastern Europe**  
Telephone: 31(0)183-696969  
Fax: 31(0)183-629055  
E-mail: [order@edc.katun.com](mailto:order@edc.katun.com)

OEM PN	KATUN PN	DESCRIPTION	MODEL NO.
-----------	-------------	-------------	--------------

## Thermal Control Devices

G0204185	85017282 	Thermistor	D 420, D 425
----------	---	------------	--------------









For use in  
**Nashuatec**  
 Copiers

**Central/Eastern Europe**  
 Telephone: 31(0)183-696969  
 Fax: 31(0)183-629055  
 E-mail: order@edc.katun.com

OEM PN	KATUN PN	DESCRIPTION	MODEL NO.
--------	----------	-------------	-----------

## Toners/Toner Cartridges

2961425	85017099 	<b>Black Toner</b> 216 g / Cartridge Equivalent to Type 2105D, 2205D, 2305D This toner is labled for use in Ricoh copiers. 6 Cartridges per Master Carton	D 425	<i>Priced per Carton, 6 Cartridges per Carton.</i>
N/P/N	85023140 	<b>Black Toner</b> 700 g / Cartridge Equivalent to Type 3100D, 3200D Robust thermal characteristics resolve short fuser life. Consistent electrical properties result in uniform image density throughout developer life. This cartridge is labelled for use in Ricoh copiers. This cartridge can be used in the equivalent Nashuatec, Lanier, and Gestetner models only. 1 Carton (4 Cartridges) per Master Carton	D 435, D 435 s, D 445	<i>Priced per Cartridge, sold in Cartons of 4.</i>
N/P/N	85023139 	<b>Black Toner</b> 1220 g / Cartridge Equivalent to Type 5100D, 5200D This cartridge is labelled for use in Ricoh copiers. This cartridge can be used in the equivalent Nashuatec and Lanier models only. 1 Carton (4 Cartridges) per Master Carton	D 455, D 465	<i>Priced per Cartridge, sold in Cartons of 4.</i>
DT50BLK	85023036 	<b>Black Toner</b> 1220 g / Cartridge Equivalent to Type 6110D, 6210D This cartridge is labelled for use in Ricoh copiers. This cartridge can be used in the equivalent Nashuatec and Lanier models only. 1 Box (4 Cartridges) per Master Carton	D 6005, D 7505	<i>Priced per Cartridge, sold in Boxes of 4.</i>
885321	85023858	<b>Black Toner Original</b>	DSc 224, DSc 232	
885322	85023860	<b>Yellow Toner Original</b>	DSc 224, DSc 232	
885323	85023862	<b>Magenta Toner Original</b>	DSc 224, DSc 232	
885324	85023859	<b>Cyan Toner Original</b>	DSc 224, DSc 232	





## General Information

### Credit Terms and Ordering Information

#### Credit Terms

Standard credit terms are net-30-days from date of invoice. To open a net-30-day account, please contact the Katun Credit Department. Until your credit application is approved, orders will be shipped upon receipt of cash in advance or a confirmed, Sight Draft, or via C.O.D. (Nominal C.O.D. handling charges will apply.)

Katun offers a 3% cash-with-order (CWO) discount. Katun will calculate the 3% discount, promptly inform you of the total charges, and ship your order immediately upon receipt of your payment.

#### Place all orders with Katun (E.D.C.) B.V. via:

- **Telephone: 31(0) 183–696969**
- **Fax: 31(0) 183–629055**
- **E-mail: order@edc.katun.com**
- **Address:**

**Katun (E.D.C.) B.V.**  
**Edisonweg 44**  
**4207 HG Gorinchem**  
**The Netherlands**

Reference Katun part numbers on all orders.

Prices are in Euro, EX WORKS Gorinchem, The Netherlands.

Katun business hours are from 8:30 to 17.00 hours.

Katun has a € 350 minimum order. A € 35 charge will be added to orders under the minimum.

#### Wire transfer funds to:

ABN–AMRO Bank  
Daalsesingel 71  
Postbus 2059  
3500 GB Utrecht  
The Netherlands  
Account Number: 55 70 74 134  
Swift I.D.: ABN ANL 2A  
IBAN: NL51ABNA0557074134

## General Shipping Information and Product Return Policies

### Shipping and Handling

Katun can provide you with alternatives for shipping. We will attempt to select the most convenient and cost-effective carrier for you. However, if you have a preferred carrier, please inform your Katun Customer Service Representative.



## Central/Eastern Europe

Telephone: 31(0)183-696969

Fax: 31(0)183-629055

E-mail: [order@edc.katun.com](mailto:order@edc.katun.com)

Hazardous material shipments will be billed accordingly. A nominal handling charge is incorporated into our shipping costs.

## Product Return Policies

- Katun **must** preauthorize all returns. For return procedures and a return, contact the Customer Service Department at 31(0) 183–696969.
- Toner, toner cartridges, digital duplicator inks and masters, and thermal transfer ribbons with personalized labels cannot be returned to Katun for credit unless a valid warranty claim exists.
- Returns and refused shipments are subject to a minimum 10% restocking charge.
- With the exception of warranty claims, merchandise returned more than 90 days from the invoice date will not be accepted.
- Merchandise which has been written on, marked, relabeled, or placed in other than original Katun packaging will not be accepted.
- All warranty claims submitted to Katun *must* be accompanied by a completed Distributor Choice Warranty Claim Form (included in this catalog). Customers must indicate a warranty choice on the form:
  - (a) Technical Evaluation/ Replacement or technical Evaluation/ Credit: Ship the product and the completed form to:  

**Katun (E.D.C.) B.V.**  
**Edisonweg 44**  
**4207 HG**  
**Gorinchem**  
**The Netherlands**
  - (b) Automatic Replacement: send the completed form to your customer service representative.



## Allgemeine Hinweise

### Zahlungsbedingungen und Bestellinformationen

Die übliche Zahlungsweise ist bar innerhalb von 30 Tagen ab Rechnungsdatum. Zur Eröffnung eines Kontos wenden Sie sich bitte an die Katun Kreditabteilung. Bis zur Gewährung Ihres Kredits erfolgt der Versand von Bestellungen bei Vorkasse oder bei Erhalt eines bestätigten, Sichtwechsel oder gegen Nachnahme (unter Berechnung einer geringen Nachnahmegebühr).

Katun gewährt 3 % Skonto für Barzahlung bei Bestellung. Katun wird den Skontobetrag errechnen, Ihnen den Gesamtbetrag mitteilen und Ihre Bestellung unverzüglich nach Erhalt Ihrer Zahlung zum Versand aufgeben.

Bitte richten Sie alle Bestellungen an Katun (E.D.C.) B.V. unter:

- **Telefon: 31 (0) 183–696969**
- **Fax: 31 (0) 183–629055**
- **E-mail: order@edc.katun.com**
- **Adresse:**

**Katun (E.D.C.) B.V.**  
**Edisonweg 44**  
**NL-4207 HG Gorinchem**  
**Niederlande**

Bitte bei allen Bestellungen die Katun Artikelnummern angeben. Preise verstehen sich in Euro, ab Werk Gorinchem, Niederlande.

Katun Geschäftszeit ist 8.30 - 17.00 Uhr. Für alle Bestellungen gilt ein Mindestbestellwert von € 350. Bei Bestellungen unter dem Mindestbestellwert wird ein Zuschlag von €35 berechnet.

#### Bankverbindung:

ABN AMRO Bank  
Daalsesingel 71  
Postbus 2059  
NL-3500 GB Utrecht  
Niederlande  
Kontonummer: 55 70 74 134  
Bankleitzahl: ABN ANL 2A  
IBAN: NL51ABNA0557074134

### Versand und Warenrücksendung

#### Bearbeitung und Versand

Katun bietet verschiedene Versandmethoden an. Wir bemühen uns, die für Sie günstigste und praktischste Versandart zu wählen. Falls Sie eine bestimmte Versandart/Firma vorziehen, teilen Sie dies bitte Ihrem Katun Repräsentanten mit.



## Central/Eastern Europe

Telephone: 31(0)183-696969

Fax: 31(0)183-629055

E-mail: [order@edc.katun.com](mailto:order@edc.katun.com)

Versandkosten für Gefahrgüter werden entsprechend berechnet. Eine geringe Bearbeitungsgebühr ist in unseren Versandgebühren enthalten.

## Warenrücksendung

- Nur von Katun vorher genehmigte Waren- rücksendungen können bearbeitet werden. Bitte lassen Sie sich vom Kundendienst unter der Telefonnummer 31 (0) 183-696969 genaue Anweisungen geben.
- Bei Warenrücksendungen werden 10 % Rücknahmegebühren in Abzug gebracht.
- Toner, Drucker-/Faxkartuschen, Tinten für digitale Duplikatoren sowie Thermo-Transfer-Bänder mit Firmenetiketten sind vom Umtausch ausgeschlossen, es sei denn, es liegt ein Garantiefall vor.
- Ware, die nach Ablauf von 90 Tagen ab Rechnungsdatum zurückgeschickt wird, kann nicht zurückgenommen werden (mit Ausnahme von Reklamationen).
- Ware, deren Verpackung markiert, etikettiert oder beschriftet wurde, oder Ware ohne Originalverpackung kann nicht zurückgenommen werden.
- Alle Garantieansprüche müssen von einem ausgefüllten Händler -Garantieformular begleitet sein ( Formular in diesem Katalog enthalten). Geben Sie Ihren Regulierungswunsch auf dem Formular an:
  - (a) Technische Bewertung/Ersatz oder Technische Bewertung/Gutschrift: schicken Sie das Produkt und das vollständig ausgefüllte Formular an:

**Katun (E.D.C.) B.V.**  
**Edisonweg 44**  
**NL-4207 HG Gorinchem**  
**Niederlande**
  - (b) Ersatz ohne Bewertung: schicken Sie das vollständig ausgefüllte Formular an Ihren Ansprechpartner der Auftragsbearbeitung.

## DISTRIBUTOR CHOICE WARRANTY CLAIM FORM

*Please print all information. For prompt processing of your claim, please complete all sections. Your feedback is important to the ongoing improvement of Katun products. Thank you.*

### I. WARRANTY CHOICE

*Please check one. See Section 2 on reverse side for additional information.*

Technical Evaluation/Replacement       Technical Evaluation/Credit       Automatic Replacement

### II. CUSTOMER INFORMATION

Customer Number: \_\_\_\_\_ Date Shipped: \_\_\_\_\_

Company Name: \_\_\_\_\_ Delivery Date: \_\_\_\_\_

Address: \_\_\_\_\_

City: \_\_\_\_\_ State/Province: \_\_\_\_\_

Country: \_\_\_\_\_ Postal Code: \_\_\_\_\_

Your Name: \_\_\_\_\_ Title: \_\_\_\_\_

### III. PRODUCT INFORMATION

Katun PN	Quantity	Description	Serial/Lot Number
1) _____	_____	_____	_____
2) _____	_____	_____	_____
3) _____	_____	_____	_____
4) _____	_____	_____	_____
5) _____	_____	_____	_____

### IV. DETAILED REASON(S) FOR CLAIM

Provide specific information for each product claimed, explaining the reason for claim in as much detail as possible. Include machine models, machine log information, and copy/print counts. **See Section 3 on reverse side for additional specific requirements for photoreceptors.**

1) \_\_\_\_\_

2) \_\_\_\_\_

3) \_\_\_\_\_

4) \_\_\_\_\_

5) \_\_\_\_\_

#### **FOR KATUN USE ONLY**

Product Warranty Claim No.: \_\_\_\_\_

Pieces: \_\_\_\_\_

Received By: \_\_\_\_\_

Date: \_\_\_\_\_

## Central/Eastern Europe

Telephone: 31(0)183-696969

Fax: 31(0)183-629055

E-mail: order@edc.katun.com

## PLEASE READ AND COMPLY WITH ALL THESE REQUIREMENTS TO EXPEDITE THE PROCESSING OF YOUR CLAIM.

### 1. General Instructions

A completed copy of this form must accompany all product warranty claims. Please indicate date of product delivery for determination of warranty coverage time period. *Your feedback is important to the ongoing improvement of Katun products. Please complete all sections on the reverse side.*

### 2. Distributor Choice Warranty Claim Options

Please indicate your choice of Technical Evaluation/Replacement, Technical Evaluation/Credit, or Automatic Replacement. **NOTE:** Automatic Replacement claims must be filed within 90 days of product delivery date, and must not exceed US\$500/€ 550.

If no choice is indicated:

- (a) If product is included with this form, this claim will be treated as Technical Evaluation/Replacement.
- (b) If no product is included with this form, and the claim is less than US\$500/€ 550, this claim will be treated as Automatic Replacement.
- (c) If no product is included with this form, and the claim is more than US\$500/€ 550, the claim is invalid.

### 3. Specific Requirements

If damage (for example, a chip or scratch on a photoreceptor) is noted "out-of-box," DO NOT INSTALL THE PRODUCT. No copy/print samples are required. Installing a product with out-of-box damage could void the warranty.

*Include applicable copy/print samples with all claims.* If a photoreceptor is suspected to be defective after machine installation, please attach to this form the copy/print samples indicated below. This will allow a thorough evaluation of the claim. Ensure that neither the form nor copy/print samples will contact the photoreceptor surface during shipment.

**FOR PHOTORECEPTORS USED IN COPIERS,** include:

- (a) Three "sky shot" (open platen; black) copies;
- (b) Three white copies; and
- (c) Three copies of a test pattern.

**NOTE:** If the defect is not visible on the copies indicated above, please attach three copies which clearly show the defect.

**FOR PHOTORECEPTORS USED IN PRINTERS AND PLAIN PAPER FACSIMILES,** include three prints which clearly show the defect.

**IMPORTANT:** The Katun product warranty does not cover damage by operator, technician, or machine (including rotational scratches, gouges, scuff marks, or line scratches).

### 4. Shipping Instructions

ALL PRODUCT RETURNS MUST BE PROPERLY PACKAGED. This includes packaging in the correct individual product box and in a second container with adequate protective packaging material. This is required by all carriers.

**NOTE:** Products damaged in transit to Katun due to inadequate packaging cannot be covered by the Katun product warranty, and will be returned.

**Ship Technical Evaluation claims, freight prepaid, to the address specifically indicated for this purpose in the "General Information" section of the Katun On-Line Catalogue and current printed catalogues.** Katun cannot accept responsibility for product warranty claims sent to any other address. **Send Automatic Replacement Claims to your Katun Customer Service Representative.**

## HÄNDLER-GARANTIEFORMULAR

*Das Formular bitte in Druckschrift ausfüllen. Um eine umgehende Bearbeitung Ihrer Reklamation zu ermöglichen, tragen Sie bitte alle Angaben ein.*

*Ihr Feedback trägt zur weiteren Verbesserung von Katun-Produkten bei. Vielen Dank.*

### I. REGULIERUNGSWUNSCH

*Bitte nur einen ankreuzen. Weitere Informationen finden Sie in Abschnitt 2 auf der Rückseite.*

Technische Bewertung/Ersatz     Technische Bewertung/Gutschrift     Ersatz ohne Bewertung

### II. KUNDENINFORMATIONEN

Kunden-Nr.: \_\_\_\_\_ Versanddatum: \_\_\_\_\_

Firmenname: \_\_\_\_\_ Lieferdatum: \_\_\_\_\_

Straße: \_\_\_\_\_

Postleitzahl: \_\_\_\_\_ Ort: \_\_\_\_\_

Land: \_\_\_\_\_

Ihr Name: \_\_\_\_\_ Titel/Funktion: \_\_\_\_\_

### III. PRODUKTINFORMATIONEN

	Katun-Artikel-Nr.	Menge	Bezeichnung	Serien-/Lotnummer
1)	_____	_____	_____	_____
2)	_____	_____	_____	_____
3)	_____	_____	_____	_____
4)	_____	_____	_____	_____
5)	_____	_____	_____	_____

### IV. AUS WELCHEM GRUND REKLAMIEREN SIE DIE WARE?

Machen Sie bitte zu jedem reklamierten Artikel so ausführliche und genaue Angaben wie möglich. Des weiteren benötigen wir Angaben zum Gerätemodell, eine Kopie des Bordbuches sowie Informationen bezüglich der Anzahl der erstellten Kopien/Ausdrucke des Produktes. **Bitte beachten Sie Punkt 3 auf der Rückseite mit wichtigen Informationen zur Reklamation von Fotorezeptoren.**

1) \_\_\_\_\_

2) \_\_\_\_\_

3) \_\_\_\_\_

4) \_\_\_\_\_

5) \_\_\_\_\_

#### **NUR FÜR DEN INTERNEN GEBRAUCH**

Reklamations-Nr.: \_\_\_\_\_ Stückzahl: \_\_\_\_\_

Entgegengenommen von: \_\_\_\_\_ Eingangsdatum: \_\_\_\_\_



## Central/Eastern Europe

Telephone: 31(0)183-696969

Fax: 31(0)183-629055

E-mail: order@edc.katun.com

## BITTE BEACHTEN SIE FOLGENDE HINWEISE, UM DIE BEARBEITUNG IHRER REKLAMATION ZU BESCHLEUNIGEN.

### 1. Allgemeine Hinweise

Verwenden Sie diesen Mängelbericht bei allen Reklamationen. Geben Sie zur Bestimmung der Garantiefrist bitte das Lieferdatum des Produktes an. *Ihr Feedback trägt zur weiteren Verbesserung von Katun-Produkten bei. Bitte tragen Sie alle Angaben auf der Rückseite vollständig ein.*

### 2. Händler-Garantieoption

Geben Sie bitte Ihren Regulierungswunsch an (Technische Bewertung/Ersatz, Technische Bewertung/Gutschrift oder Ersatz ohne Bewertung.) **BITTE BEACHTEN:** Reklamationen ohne Bewertung müssen innerhalb von 90 Tagen nach dem Lieferdatum des Produktes geltend gemacht werden und dürfen einen Wert von USD 500/Euro 550 nicht überschreiten.

Wenn keine Wahl getroffen wurde:

- (a) Wenn diesem Formular das Produkt beigelegt wurde, wird diese Reklamation als Technische Bewertung/Ersatz bearbeitet.
- (b) Wenn diesem Formular kein Produkt beigelegt wurde und der Wert der Reklamation weniger als USD 500/ Euro 550 beträgt, wird diese Reklamation als Ersatz ohne Bewertung bearbeitet.
- (c) Wenn diesem Formular kein Produkt beigelegt wurde und der Wert der Reklamation mehr als USD 500/ Euro 550 beträgt, besteht kein Anspruch auf Reklamation.

### 3. Spezielle Anforderungen

Wenn Schäden (z.B. Splitter oder Kratzer an einem Fotorezeptor) bereits „beim Auspacken“ festgestellt werden, dann **INSTALLIEREN SIE DAS PRODUKT NICHT.** Testkopien sind nicht erforderlich. Die Installation eines Produktes mit bereits bestehendem Schaden könnte zum Erlöschen Ihrer Garantieansprüche führen.

*Fügen Sie allen Reklamationen entsprechende Testkopien bei.* Wenn ein Fotorezeptor nach der Installation einen Defekt aufzuweisen scheint, legen Sie diesem Formular bitte die nachstehend beschriebenen Testkopien bei, um eine genaue Beurteilung der Mängel zu ermöglichen. Das Formular sowie die Testkopien dürfen bei der Rücksendung auf keinen Fall mit der Oberfläche des Fotorezeptors in Berührung kommen.

**FÜR FOTOREZEPTOREN, DIE IN KOPIERERN BENUTZT WURDEN,** folgende Testkopien beilegen:

- (a) 3 schwarze Kopien (bei offener Vorlagenglas-Abdeckung),
- (b) 3 weiße Kopien und
- (c) 3 Testkopien (vom Testbogen).

**BITTE BEACHTEN:** Ist der Defekt auf diesen Mustern nicht sichtbar, legen Sie bitte 3 Kopien bei, auf denen er deutlich zu erkennen ist.

**FÜR FOTOREZEPTOREN, DIE IN DRUCKERN UND NORMALPAPIER-FAXGERÄTEN BENUTZT WURDEN,** legen Sie bitte 3 Kopien bei, auf denen der Defekt deutlich zu erkennen ist.

**WICHTIG:** Schäden, die durch falsche Bedienung des Endanwenders, durch den Techniker oder das Gerät verursacht wurden (d. h. umlaufende Kratzer, Streifen, Abrieb oder querlaufende Kratzer), sind von der Katun Qualitätsgarantie ausgeschlossen.

### 4. Versandrichtlinien

ALLE TEILE, DIE AN UNS ZURÜCKGESANDT WERDEN, MÜSSEN SACHGEMÄSS VERPACKT SEIN, d. h. in dem entsprechenden Einzelkarton und einem zweiten Karton mit entsprechendem Verpackungsmaterial. Dies betrifft jeglichen Transportweg!

**BITTE BEACHTEN:** Teile, die nicht sachgemäß verpackt werden und uns aus diesem Grunde defekt erreichen, sind von der Katun-Qualitätsgarantie ausgeschlossen und werden nicht angenommen.

**Schicken Sie Ihre Reklamation zur technischen Bewertung (frachtfrei) an die für diese Zwecke im Katun-Online-Katalog und dem gültigen regulären Katalog unter den „allgemeinen Hinweisen“ angegebene Adresse.** Katun übernimmt keinerlei Verantwortung für Reklamationen, die an eine andere Adresse als die oben genannte geschickt werden. **Schicken Sie Reklamation zum Ersatz ohne Bewertung an Ihren Katun-Ansprechpartner.**

