

Katun Products for use in

Sharp

Table of Contents

	<i>Page</i>
Copy Machine Equivalency List	i
Descriptions of Katun Product Brands and Technologies	v
Beschreibungen der Produktmarken und Technologien von Katun	ix
Personalized Product Agreement	xiii
Vereinbarung Über Bestellung Von Produkten Mit Ihrem Firmenetikett	xv
Fax Order Form	xvii
Fax-Bestellformular	xix
Toners and Developers	1
Photoreceptors	8
Memory Upgrades	13
Parts	
For use in Models:	
AL 1000, AL 1200	14
AL F 880	14
AR 120 E, AR 121 E, AR 150, AR 150 E, AR 151, AR 151 E, AR 156, AR F 151, AR F 152	14
AR 122 E, AR 122 E N, AR 123 E, AR 152 E, AR 152 E N, AR 153 E, AR 153 E N, AR 157 E, AR 157 E N	16
AR 122 EN	16
AR 160, AR 161, AR 200, AR 200 S, AR 200 SE, AR 205	17
AR 162, AR 163, AR 201, AR 206, AR 207, AR F 201	18
AR 168 D	19
AR 168 S	19
AR 235, AR 275	19
AR 250, AR 286, AR 336	20
AR 280, AR 285, AR 335	23
AR 281	26
AR 287, AR 337	29
AR 405, AR 407	31
AR 501, AR 505, AR 507	35
AR 651	38
AR 810	38
AR 5015	39
AR 5040	40
AR 5125, AR 5132	42
AR C 150, AR C 250	45
AR C 160, AR C 270	46
AR C 260	47
AR C 260 M	47
AR C 860	47
AR C 861, AR C 862	48
AR M 160	49
AR M 205	49
AR M 208	50
AR M 236	50
AR M 237	50



Central/Eastern Europe

Telephone: 31(0)183-696969

Fax: 31(0)183-629055

E-mail: order@edc.katun.com

For use in Models:

AR M 276	51
AR M 277	51
AR M 350, AR M 450	51
AR M 350 N	52
AR M 350 NB	52
AR M 350 U	52
AR M 350 UB	52
AR M 450 N	52
AR M 450 N+	53
AR M 450 NB	53
AR M 450 U	54
AR M 450 U+	54
AR M 450 UB	55
AR M 550 N, AR M 550 U	55
AR M 620 N, AR M 620 U	55
AR M 700 N, AR M 700 U	56
CX 7500, CX 7700	56
DM 1500	56
DM 1505	56
DM 2000, DM 2005, DM 2010, DM 2015	57
SD 2060, SD 3062	57
SD 2075, SD 3076	61
SD 2260	62
SD 2275	65
SD 4085	67
SF 740, SF 741	68
SF 750	69
SF 755, SF 756, SF 760	69
SF 770, SF 771, SF 780, SF 781, SF 7400	70
SF 810, SF 810 CN, SF 811, SF 811 CN, SF 820, SF 850	70
SF 815, SF 815 CN, SF 816, SF 825, SF 826	71
SF 900, SF 901	71
SF 1016, SF 1018, SF 1020, SF 2116, SF 2118	72
SF 1025, SF 2022, SF 2022 N, SF 2027, SF 2027 N	74
SF 1116	77
SF 1120	80
SF 2010	80
SF 2014	80
SF 2018	82
SF 2020, SF 2120, SF 2220, SF 2320	82
SF 2025, SF 2030, SF 2040	84
SF 2035	88
SF 2050, SF 2052	92
SF 2114, SF 2214	97
SF 2216	99
SF 2218	101
SF 2314	103
SF 2414, SF 2514	104
SF 2530	106
SF 2540	108
SF 6100, Z 72	111

For use in Models:

SF 7100, SF 7200	111
SF 7300, SF 7350	111
SF 7320, SF 7370	113
SF 7500	115
SF 7700, SF 7750	115
SF 7800, SF 7830, SF 7850	116
SF 7900, SF 8300, SF 8350, SF 8400	118
SF 8100, SF 8260	120
SF 8200	120
SF 8500, SF 8570, SF 8800, SF 8870	121
SF 8600, SF 9300	123
SF 9400	124
SF 9500, SF 9550	124
SF 9600	125
SF 9700, SF 9750, SF 9800	126
Z 25	127
Z 27	128
Z 30	128
Z 50, Z 52, Z 55, Z 70, Z 85, Z 85 II, Z 87, Z 88	128
Z 60	128
Z 810, Z 830, Z 845	129

For use in Accessories:

Document Feeder	129
Paper Feed Unit	131
Pedestal	132
Cassette Module	133
Duplex Unit	134
Finisher	134
Fax Module	134
Lct	134
Manual Feeder	136
Sorter	136

Kits	137
-------------------	-----

OEM Part Number Cross-Reference	I
--	---

General Information	XXVII
----------------------------------	-------

Allgemeine Hinweise	XXIX
----------------------------------	------

Distributor Choice Warranty Claim Form	XXXI
---	------

HÄNDLER-GARANTIEFORMULAR	XXXIII
---------------------------------------	--------

Copy Machine Equivalency List

Central/Eastern Europe
 Telephone: 31(0)183-696969
 Fax: 31(0)183-629055
 E-mail: order@edc.katun.com

Sharp	Lanier Worldwide	Olivetti Lexikon	Telesystems	Xerox
AL 1000		COPIA 9910 -A		WorkCentre XD 100
		COPIA 9910 -B		WorkCentre XD 102
		COPIA 9912 -A		WorkCentre XD 103 f
		COPIA 9912 -B		WorkCentre XD 104
				WorkCentre XD 105 f
				WorkCentre XD 120 f
AL 1200		COPIA 9910 -A		WorkCentre XD 100
		COPIA 9910 -B		WorkCentre XD 102
		COPIA 9912 -A		WorkCentre XD 103 f
		COPIA 9912 -B		WorkCentre XD 104
				WorkCentre XD 105 f
				WorkCentre XD 120 f
				WorkCentre XD 155 df
AL 1520		COPIA 9915 -A		
		COPIA 9915 -B		
AL 1521		COPIA 9915 -F		
AR 120 E		D-COPIA 120		
AR 121 E		d-COPIA 12		
AR 150 E		D-COPIA 150		
AR 161	5216			
AR 205	5220			
AR C 860	5506 DC			
AR C 861	5606 DC-E			
AR C 862	5606 DC-E			
AR F 151				WorkCentre Pro 16 fx
CX 7500			COPYMAT F-X 10	
SD 4085	7385			
SF 710		COPIA 1500		
SF 721		COPIA 1550		
SF 730		COPIA 1600		
SF 740		COPIA 1400		
SF 741		COPIA 1450	COPYMAT 30-40	
SF 750			COPYMAT 20-40	
SF 755			COPYMAT 20-41	
SF 756			COPYMAT 20-42	
SF 760		COPIA 7030	COPYMAT 20-50	
SF 770		COPIA 1700	COPYMAT 40-30	
SF 771		COPIA 1710		
SF 780		COPIA 1800	COPYMAT 40-50	
SF 781		COPIA 1810		
SF 811			COPYMAT 50-30	
SF 815		COPIA 2510	COPYMAT 60-30	
SF 820			COPYMAT 50-50	
SF 825		COPIA 2550	COPYMAT 60-50	
SF 850			COPYMAT 50-31	
SF 900			COPYMAT 70-50	
SF 2010	6610			5309
SF 2014				5614
SF 2114	6614			5614 Z
SF 2116	6716			
SF 2118	6718			
SF 2214	6714			5614 ZSD
SF 2216	7216			
	7316			

Copy Machine Equivalency List

Sharp	Lanier Worldwide	Olivetti Lexikon	Telesystems	Xerox
SF 2414	7214			
SF 2514	7314			
SF 6100			COPYMAT 10-55	5009 R/E
SF 7100			COPYMAT 20-43	
SF 7300	6113		COPYMAT 30-45	
SF 7320	6413			
SF 7350	6213		COPYMAT 30-46	
SF 7370	6514			
SF 7400			COPYMAT 40-31	
SF 7500			COPYMAT 30-60	
SF 7700			COPYMAT 40-35	
SF 7750			COPYMAT 40-60	
SF 7800			COPYMAT 40-65	
SF 7850			COPYMAT 40-66	
SF 8100			COPYMAT 50-60	
SF 8200			COPYMAT 60-60	
SF 8260			COPYMAT 60-61	
SF 8300			COPYMAT 50-65	
SF 8350			COPYMAT 50-66	
SF 8400			COPYMAT 50-85	
SF 8500			COPYMAT 60-65	
SF 8570			COPYMAT 60-68	
SF 8600			COPYMAT 70-60	
SF 8800			COPYMAT 70-65	
SF 8870			COPYMAT 70-68	
SF 9300			COPYMAT 70-70	
SF 9400			COPYMAT 70-78	
SF 9500			COPYMAT 80-60	
SF 9550			COPYMAT 80-70	
SF 9600			COPYMAT 80-40	
SF 9700			COPYMAT 80-65	
SF 9750			COPYMAT 80-75	
SF 9800			COPYMAT 80-76	
Z 20				5201
Z 21				XC 351
				XC 356
Z 25				5305
Z 26				XC 355
Z 27				5306
Z 30			COPYMAT 10-20	5220
Z 50			COPYMAT 10-40	5008 S
Z 55				5008
				5009
				5240
Z 60			COPYMAT TRI COLOR	
Z 70			COPYMAT 10-50	5008 R/E
Z 88				5280
				5310
Z 810				XC 811
Z 830				XC 830
Z 845				XC 1040
				XC 1245
AR- DE 5	SS- 516 -1			

Copy Machine Equivalency List

Central/Eastern Europe
Telephone: 31(0)183-696969
Fax: 31(0)183-629055
E-mail: order@edc.katun.com

Sharp	Lanier Worldwide	Olivetti Lexikon	Telesystems	Xerox
AR- DE 6	SS- 516 -2			
AR- SP 2	ADF- 516			
AR-C XJ 170	FIERY- XJ 170 PLUS			
AR-C XJ 300	FIERY- XJ 300 PLUS			
FIERY- XJ BP 100	FIERY- XJ BP 100			
SF- 461		ADF- 501		
SF- A 15	ADF- 16			
SF- CM 14	CD- 14			
SF- MF 15	SFB- 16			

Descriptions of Katun Product Brands and Technologies

Katun Performance Products

Katun Performance is our complete line of office automation products that combine our highest quality level with consistent, reliable performance and competitive pricing - and provide excellent overall value.

Katun Performance products meet strict quality guidelines and have been 100% tested and approved according to the Katun 360° Certification process, which includes environmental testing, forward and reverse compatibility testing, model application testing, and component compatibility testing. In addition, all Katun Performance products are warranted to be free from functional defects in material and workmanship for one year and come with the highest level of Katun technical support.

To locate Katun Performance products, look for the Katun Performance icon  throughout this catalog.

Access by Katun Products

Access by Katun is a line of selected products that address the unique pricing or product needs of specific markets. Access by Katun products provide market acceptable quality and market competitive pricing. The Access by Katun product line complements the Katun Performance line by providing a value proposition based primarily on specific market needs.

Access by Katun products come with a limited level of product support and a one-year warranty. Although Access by Katun products provide some price advantages, remember that Katun Performance products always provide excellent overall value.

Original Products

Select OEM brand products that Katun offers to meet certain market needs

Fuser Roller Coating Technologies

Minco Manufacturing, Inc., a wholly owned subsidiary of Katun Corporation, is a world-leading manufacturer of fuser rollers for use in plain paper copiers, facsimiles, and printers. The product development relationship between Katun, Minco, and DuPont, the exclusive manufacturer of genuine TEFLON[®] brand coatings, has produced numerous advanced fuser roller coating technologies, including:

DURAPREM[™] II upper fuser rollers are manufactured with a heat-resistant, nonstick TEFLON[®] brand coating that provides increased surface hardness for extended potential life. A proprietary finishing process produces an exceptionally smooth surface, which contributes to these rollers' excellent fusing performance and toner release in machines using negative-charge toner.

DURACON[™] II upper fuser rollers are manufactured with a heat-resistant, nonstick TEFLON[®] brand coating that includes patented conductive additives for static dissipation. These rollers provide excellent fusing performance, toner release, and long life, primarily in machines using positive-charge toner.

ALUMANA[™] upper fuser rollers are manufactured with extremely hard, tough primer and midcoat layers for maximum resistance to wear and abrasion. The ceramic ALUMANA coating combines a DuPont-patented polymer blend with reinforcing oxides for enhanced durability. These heavy-duty rollers are specifically designed to meet the demands of hostile fuser station environments and higher-speed machines using either positive-charge or negative-charge toner.

TRITON[™] II upper fuser rollers are manufactured with an advanced TEFLON[®] brand coating that provides improved fusing performance and nonstick characteristics in comparison to conventional fluoropolymer coatings. Unique static-dissipative particulates within the TRITON II coating, together with enhanced manufacturing processes, contribute to these rollers' superior abrasion-resistance and excellent toner release. These rollers provide extended potential life in selected machines using either positive-charge or negative-charge toner.

Central/Eastern Europe

Telephone: 31(0)183-696969

Fax: 31(0)183-629055

E-mail: order@edc.katun.com

TRITON BLUE™ upper fuser rollers deliver excellent performance for machine applications that are tough on fuser rollers. Manufactured with an advanced TEFLON® brand coating that provides improved fusing performance and nonstick characteristics in comparison to conventional fluoropolymer coatings, TRITON BLUE™ fuser rollers combine improved wear resistance with superior abrasion-resistance and excellent toner release.

REVOLUTION™ upper fuser rollers utilize a PFA sleeve coating that is more environmentally friendly than standard spray technology, while still achieving uniform coating thickness and even heat distribution. These fuser rollers provide proper fusing, excellent abrasion resistance and long life, even during extensive copy runs.

TUF/SIL™ upper fuser rollers are manufactured with a layer of silicone rubber that effectively regulates heat flow to the toner, plus an outermost layer that consists of a specially blended TEFLON® brand coating providing excellent toner release and abrasion-resistance. This combination ensures reduced toner offsetting and improved, more consistent copy quality under certain demanding machine usage conditions. These rollers provide a high-performance, cost-effective solution for selected machines required to consistently produce the best possible copy quality.

MICROSLEEVE™ lower pressure rollers, with nonstick PFA sleeves 50, 70, or 100 microns in thickness, provide excellent wear-resistance for improved copy quality over an extended life. A-Series MICROSLEEVE™ lower pressure rollers are designed specifically for machines utilizing lower fuser cleaning rollers. Their unique surface texture reduces toner buildup and improves cleaning efficiency within the fuser station.

All Katun fuser rollers are designed specifically for their intended applications and manufactured to exacting quality standards, ensuring their excellent performance and long life.

Fuser Cleaning Roller Coating Technologies

Katun has introduced unique fuser cleaning roller technologies for machines requiring efficient removal and absorption of excess toner and contaminants, as well as continuous silicone oil lubrication of critical fuser station parts. For many machines, the ideal parts combination for achieving optimum copy quality and maximum parts life includes a specially designed Katun fuser cleaning roller.

FIBRA™ fuser cleaning rollers incorporate a uniform network of special fibers that aggressively remove excess toner and contaminants from the contacted surface. By efficiently depositing toner and contaminants beneath its outermost surface, the unique FIBRA network also helps maintain a continuous lubricative flow of silicone oil from the roller's internal tank to critical fuser station parts.

FIBRA™ II fuser cleaning rollers incorporate a unique configuration of highly heat-resistant fibers to greatly enhance cleaning performance, especially in hostile fuser station environments. Efficient absorption of excess toner and contaminants, together with continuous silicone oil lubrication of critical fuser station parts, effectively reduce parts and service expenses associated with the fuser station.

TEFLON® is a registered trademark of E.I. DuPont de Nemours and Company used under license by Katun Corporation.



Personalized Product Program

Katun offers an extremely cost-effective way for office equipment dealers/distributors to ensure repeat business and strengthen relations with customers. The **Personalized Product program** enables dealers/distributors to provide high-quality Katun Performance imaging supplies (toner, fax and printer toner cartridges, digital duplicator inks and masters and thermal transfer ribbons) with their business name and /or logo, plus contact information, so end-users always know whom to call to reorder. For a one-time, nominal set-up fee, Katun designs and produces full-color labels to customer specifications and applies them to packaging at no extra charge. Only end-user-replaceable Katun Performance products are eligible under the program. Enrollment is simple and easy. Just complete the agreement form and submit it to your Katun sales representative or visit the [Personalized Products](#) page for more program and enrollment information.

Beschreibungen der Produktmarken und Technologien von Katun

Katun Performance-Produkte

Katun Performance ist unsere umfangreiche Produktreihe von Büromaschinenprodukten, die sich durch hohe Qualität sowie durch beständige, zuverlässige Leistung und attraktive Preise auszeichnen. Mit diesen Produkten soll der Nutzwert für den Kunden maximiert werden.

Katun Performance -Produkte erfüllen strenge Qualitätsstandards und wurden alle im Rahmen des 360° -Zertifizierungsverfahrens von Katun getestet und freigegeben. Die Produkte durchlaufen dabei Prüfungen der Umweltverträglichkeit, der Kompatibilität, der Modellanwendungen und der Komponentenkompatibilität. Darüber hinaus wird bei allen Katun Performance-Produkten ein Jahr lang gewährleistet, dass diese frei von funktionalen Material- und Verarbeitungsfehlern sind. Selbstverständlich steht Ihnen auch der hochwertige technische Support von Katun zur Verfügung.

Um die Katun Performance-Produkte zu finden, halten Sie in diesem Katalog nach dem Namen Performance  und dem entsprechenden Symbol Ausschau.

Originalprodukte

Sie können verschiedene OEM-Produkte auswählen, die Katun aufgrund der Nachfrage auf dem Markt in sein Produktangebot aufgenommen hat.

Beschichtungstechnologien für Heizwalzen

Minco Manufacturing Incorporated, eine hundertprozentige Tochtergesellschaft der Katun Corporation, ist einer der weltweit führenden Hersteller von Heizwalzen für Kopierer, Faxgeräte und Drucker. Die enge Zusammenarbeit zwischen Katun, Minco und DuPont, dem alleinigen Hersteller originaler TEFLON[®] - Beschichtungen, hat zur Entwicklung von zahlreichen neuartigen Beschichtungsmaterialien für Heizwalzen geführt:

DURAPREM[™] II Heizwalzen sind mit einer temperaturbeständigen TEFLON[®] - Antihaf-Beschichtung ausgestattet und besitzen daher eine größere Oberflächenhärte für eine potenziell längere Lebensdauer. Die nach einem speziellen Finish-Verfahren hergestellte, außerordentlich glatte Walzenoberfläche bietet hervorragende Fixier- und Antihaf-Eigenschaften in Geräten mit negativ geladenem Toner.

DURACON[™] II Heizwalzen sind mit einer temperaturbeständigen TEFLON[®] - Antihaf-Beschichtung ausgestattet, der patentierte, elektrisch leitfähige Inhaltsstoffe beigemischt sind, um das Ableiten von sich bildender statischer Ladung zu ermöglichen. Diese Heizwalzen zeichnen sich durch ihre hervorragenden Fixier- und Antihaf-Eigenschaften sowie eine lange Nutzungsdauer aus, besonders in Geräten mit positiv geladenem Toner.

ALUMANA[™] Heizwalzen besitzen eine äußerst harte, widerstandsfähige Grund- und Zwischenschicht für eine höchstmögliche Verschleißfestigkeit und Haltbarkeit. Die ALUMANA Keramiksicht beinhaltet eine patentierte Polymer-Mischung von DuPont mit Verstärkungsoxiden für eine erhöhte Widerstandsfähigkeit.

Diese robusten Heizwalzen sind speziell für anspruchsvolle Betriebsbedingungen in der Fixierstation und für schnellere Kopierer mit positiv oder negativ geladenem Toner konstruiert.

TRITON[™] II Heizwalzen zeichnen sich durch ihre hochwertige TEFLON[®] -Beschichtung aus, die herkömmlichen Fluorpolymer-Beschichtungen in Bezug auf Fixier- und Antihaf-Eigenschaften überlegen ist. Spezielle antistatisch wirkende Partikel in der TRITON II-Beschichtung und hohe Fertigungsstandards tragen zu den ausgezeichneten Antihaf-Eigenschaften und der hervorragenden Verschleißfestigkeit dieser Heizwalzen bei.

Sie bieten potentiell längere Laufzeiten in ausgewählten Geräten sowohl mit positiv als auch mit negativ geladenem Toner.

Central/Eastern Europe

Telephone: 31(0)183-696969

Fax: 31(0)183-629055

E-mail: order@edc.katun.com

Die TRITON BLUE™ Oberen Heizwalzen bieten eine hervorragende Leistung in Maschinenanwendungen, bei denen die Heizwalzen stark beansprucht werden. Die TRITON BLUE™ Heizwalzen werden mit einer fortschrittlichen TEFLON®-Beschichtung hergestellt, die eine höhere Heizleistung und bessere Antihaft-Eigenschaften im Vergleich zu herkömmlichen Fluorpolymerbeschichtungen bietet. Darüber hinaus zeichnen sich diese Heizwalzen durch eine hohe Verschleißfestigkeit aus.

REVOLUTION™ Obere Heizwalzen zeichnen sich durch eine PFA-Beschichtung aus, die umweltfreundlicher ist als die traditionelle Sprühtechnologie. Gleichzeitig werden eine einheitliche Beschichtungsdicke und eine gleichmäßige Hitzeverteilung sichergestellt. Zu den Vorteilen dieser Heizwalzen gehören eine optimale Fixierung, eine hervorragende Verschleißfestigkeit und eine lange Lebensdauer auch bei umfangreichen Druckläufen.

TUF/SIL™ Heizwalzen besitzen eine Silikonbeschichtung, die für eine effiziente regulierte Wärmeableitung an den Toner sorgt, sowie eine besonders zusammengesetzte TEFLON®-Beschichtung mit ausgezeichneten Antihaft-Eigenschaften und hoher Verschleißfestigkeit. Dies führt zu weniger Toner-Offsetting-Problemen und gewährleistet auch unter anspruchsvollen Betriebsbedingungen eine gleichbleibend hohe Kopienqualität. Die TEFLON®/SILIKON Heizwalzen bieten ein sehr gutes Preis-/Leistungsverhältnis für ausgewählte Geräte, die höchste Qualitätsansprüche in Bezug auf die Kopienqualität stellen.

MICROSLEEVE™ Presswalzen mit Antihaft-PFA-Ummantelung in den Stärken 50, 70 und 100 µm bieten eine außergewöhnliche Haltbarkeit und damit eine langfristig bessere Kopienqualität und längere Nutzungsdauer. Die Presswalzen der MICROSLEEVE™ A-Serie sind speziell für den Einsatz in Geräten gedacht, bei denen eine Reinigung der unteren Presswalze mittels Reinigungswalze stattfindet. Ihre besondere Oberflächenstruktur reduziert Tonerablagerungen und verbessert die Reinigungswirkung in der Fixierstation.

Alle Heizwalzen von Katun wurden speziell im Hinblick auf deren Einsatzzweck entwickelt und erfüllen höchste Qualitätsstandards. Nicht umsonst zeichnen sie sich durch eine herausragende Leistung und eine lange Nutzungsdauer aus.

Beschichtungstechnologien für Reinigungswalzen

Katun hat spezielle Reinigungswalzen für Geräte entwickelt, die eine wirksame Beseitigung von Tonerresten und Schmutz sowie eine kontinuierliche Versorgung wichtiger Teile der Fixierstation mit Silikonöl erfordern. Durch den Einsatz einer Katun Reinigungswalze kann bei vielen Geräten eine optimale Kopienqualität und eine größtmögliche Nutzungsdauer der Komponenten erzielt werden.

FIBRA™ Reinigungswalzen entfernen Tonerreste und Schmutzpartikel durch ein spezielles Fasernetz effizient von der Walzenoberfläche. Während das FIBRA-Fasernetz die Verschmutzungen wirkungsvoll in seiner Oberfläche aufnimmt, sorgt es zugleich für eine Dauerversorgung wichtiger Teile der Fixierstation mit Silikonöl aus dem Vorratstank im Walzeninneren.

FIBRA™II Reinigungswalzen besitzen ein neuartiges, hitzebeständiges Fasernetz, mit denen besonders unter anspruchsvollen Betriebsbedingungen eine erheblich verbesserte Reinigungswirkung erzielt wird.

Durch die wirksame Aufnahme von Tonerresten und Schmutzstoffen bei gleichzeitiger Dauerversorgung wichtiger Teile in der Fixierstation mit Silikonöl können die Austausch- und Servicekosten für die Fixierstation erheblich gesenkt werden.

TEFLON® ist ein eingetragenes Warenzeichen von E.I. DuPont de Nemours and Company und wird von der Katun Corporation unter Lizenz verwendet.

Firmenetiketten-Programm

Katun bietet Händlern einen äußerst kostengünstigen Weg, ihre Kunden an sich zu binden und Kundenbeziehungen zu verbessern. Das **Firmenetiketten-Programm** erlaubt es Händlern, qualitativ hochwertige Verbrauchsmaterialien von Katun Performance (Toner, Drucker-/Faxkartuschen, Tinten für Digitalkopierer und Thermotransferrollen) mit ihrem Firmennamen und/oder Logo sowie mit Kontaktinformationen zu versehen. So wissen Verbraucher immer, bei wem sie Produkte nachbestellen können. Für eine einmalige, geringe Bearbeitungsgebühr entwirft und produziert Katun Performance vollfarbige Etiketten nach Ihren eigenen Angaben. Diese werden kostenfrei auf die entsprechenden Verpackungen aufgebracht. Unter dieses Programm fallen nur Produkte, die vom Endverbraucher nachbestellt werden können. Die Teilnahme an dem Programm ist ganz einfach. Füllen Sie einfach die Vereinbarung aus und senden Sie diese an Ihren Katun- Ansprechpartner oder besuchen Sie uns auf unserer Homepage-unter Firmenetiketten-Programm für weitere Information zu diesem Programm und den Teilnahmebedingungen.

Personalized Product Agreement

Customer Information

Customer Number: _____ Phone Number: _____
 Contact Name: _____ Fax Number: _____
 Title: _____ Katun Representative: _____

Customer agrees to:

- Provide pertinent information, a scanable copy of your company logo, or other desired label artwork, and color specifications for the labels.
- Pay a one-time, nominal setup fee upon approval of the label design. (Ask your sales representative for details.)
- Order in full master carton quantities.

Katun agrees to:

- Create a personalized, full-color label design to your specifications, per the information provided on page two of this form, for a one-time, nominal setup fee and send a proof for approval within a minimum of 7 days of receipt of this agreement.
- Produce labels printed with the customer's approved design on white label stock, and affix them over the Katun Performance logo* on copier toner, printer/fax toner cartridge, digital duplicator ink/master packaging.
- Ship initial order within one week after the customer approves their Personalized Product label proof. Reorders will also ship within one week.

Projected Personalized Product Purchases

<i>Katun Part Number**</i>	<i>OEM Line</i>	<i>Product/Model Description</i>	<i>Minimum Order Quantity</i>	<i>Projected Monthly Order***</i>
P			<i>One master carton</i>	
P			<i>One master carton</i>	
P			<i>One master carton</i>	
P			<i>One master carton</i>	
P			<i>One master carton</i>	
P			<i>One master carton</i>	

Signature: _____ **Date:** _____

*Only Katun Performance products can be personalized.

**The Personalized Product part number is the regular Katun Performance part number with a 'P' added at the end. See the Katun catalog for master carton quantities.

*****Projection only.** You are not committed to ordering the quantity you list on this form.

NOTE: Products with personalized labels cannot be returned to Katun for credit unless a valid warranty claim exists.

Please Also Complete Page 2

Central/Eastern Europe

Telephone: 31(0)183-696969

Fax: 31(0)183-629055

E-mail: order@edc.katun.com

Information for Personalized Product Label

Please list *only* the information you want to appear on your Personalized Product label.

Company Name: _____

Street Address: _____

City: _____

State/Province: _____ **Postal Code:** _____

Phone Number: _____ **Fax Number:** _____

Other: _____

Label Artwork

- **Attach a copy of your company logo and/or any other requested graphic elements.** Artwork may be full color or black and white. We prefer original-quality artwork 4" x 4" (100mm x 100mm) or larger, but will accept a business card or sheet of company letterhead.
- **Please indicate your color preferences.** In the space below, please indicate the color(s) you want to use for all text, your company logo, and any other graphic elements. If appropriate, please supply accurate samples to be matched or specify Pantone or PMS color numbers. **NOTE:** Your labels will be printed on a thermal-transfer printer at a resolution of 300 dpi. Therefore color photographs cannot be printed and some colors may be difficult to match precisely.

Label Sizes

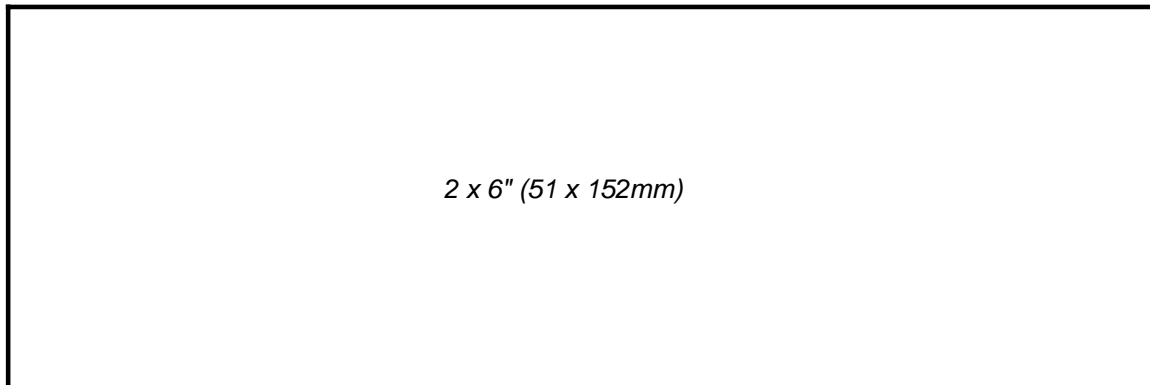
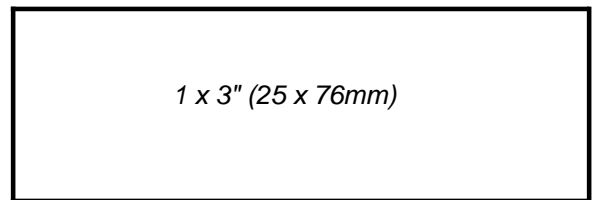
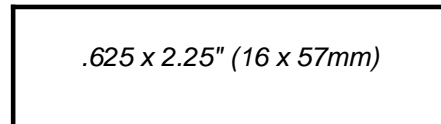
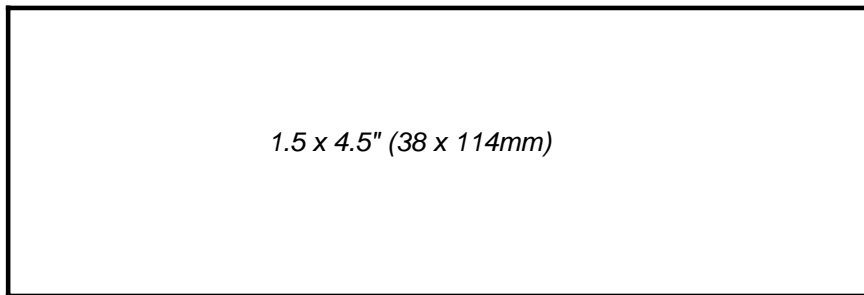

Vereinbarung über Bestellung von Produkten mit Ihrem Firmenetikett

Kundeninformationen

Kundennummer: _____ Telefon: _____
 Ansprechpartner: _____ Fax: _____
 Position: _____ Ihr Katun-Repräsentant: _____

Der Kunde ist einverstanden:

- Katun die benötigten Informationen vorzulegen (ein zum Scannen geeignetes Muster Ihres Firmenlogos bzw. Muster anderer gewünschter Grafikelemente sowie Farbspezifikationen für die Etiketten);
- nach Genehmigung des Etiketten-Layouts eine einmalige, geringe Bearbeitungsgebühr zu entrichten. Weitere Informationen erhalten Sie von Ihrem Katun-Repräsentanten;
- Toner in den jeweiligen Verpackungseinheiten/Umkartons zu bestellen.

Katun verpflichtet sich:

- ein Vollfarbetikett nach den Kundenangaben zu entwerfen (siehe Seite 2 dieses Formulars). Hierfür wird eine einmalige, geringe Bearbeitungsgebühr erhoben. Nach Eingang dieser Vereinbarung bei Katun erhält der Kunde innerhalb von ca. sieben Werktagen einen Korrekturabzug.
- Etiketten in Standardgröße mit dem vom Kunden genehmigten Layout auf weißem Etikettenpapier zu drucken und über dem Katun Performance-Logo* auf der Verpackung von Toner für Kopierer, Tonerkartuschen für Drucker/Faxgeräte, Tinte bzw. deren Umkartons für digitale Duplikatoren anzubringen.
- den Toner-Erstauftrag innerhalb von einer Woche nach Genehmigung des firmeneigenen Etiketts zu versenden. Nachbestellungen werden ebenfalls innerhalb einer Woche erledigt.

Erwartete Abnahmemenge von Produkten mit Ihrem Firmenetikett

Katun Artikelnummer**	Maschinenlinie	Produkt-/Modellbeschreibung	Mindestmenge	Erwartete monatliche Bestellung***
P			Ein Umkarton	
P			Ein Umkarton	
P			Ein Umkarton	
P			Ein Umkarton	
P			Ein Umkarton	
P			Ein Umkarton	

Unterschrift: _____ Datum: _____

*Nur Katun Performance Produkte können mit Firmenetiketten bestellt werden.

**Die Artikelnummer für Produkte mit Ihrem Firmenetikett ist die normale Katun Performance Artikelnummer, der ein "P" am Ende nachgestellt ist. Sehen Sie die Umkartonmengen im Katun-Katalog nach.

***Nur Schätzungen. Sie sind nicht verpflichtet, die hier angegebene Menge abzunehmen.

HINWEIS: Produkte mit Firmenetiketten können nur bei einer berechtigten Reklamation gutgeschrieben werden.

Füllen Sie bitte auch Seite 2 aus.

Bestellinformationen für firmeneigenes Etikett

Geben Sie bitte *nur* die Informationen an, die auf dem Etikett erscheinen sollen.

Name der Firma: _____

Strasse: _____

PLZ/Ort: _____

Telefon: _____ Fax: _____

Sonstiges: _____

Layout des Etiketts

- **Bitte legen Sie kein Muster Ihres Firmenlogos sowie ggf. Muster anderer gewünschter Grafikelemente bei.** Geeignet sind Grafiken in Farbe oder Schwarzweiß, vorzugsweise Originale mit einer Mindestgröße von 100 x 100 mm. Wir können auch Ihre Visitenkarte oder Ihren Briefkopf verarbeiten.
- **Bitte geben Sie die gewünschten Farben an.** Tragen Sie unten bitte die Farbe(n) für alle Textelemente, Ihr Firmenlogo sowie andere grafische Elemente ein. Legen Sie ggf. ein Farbmuster bei, oder geben Sie die Pantone- bzw. PMS-Farbnummern an.
HINWEIS: Ihre Firmenetiketten werden auf einem Thermodrucker mit einer Auflösung von 300 DPI erstellt. Es können daher keine Farbfotos gedruckt werden, und bestimmte Farben können u. U. nicht exakt wiedergegeben werden.



Etikettengrößen

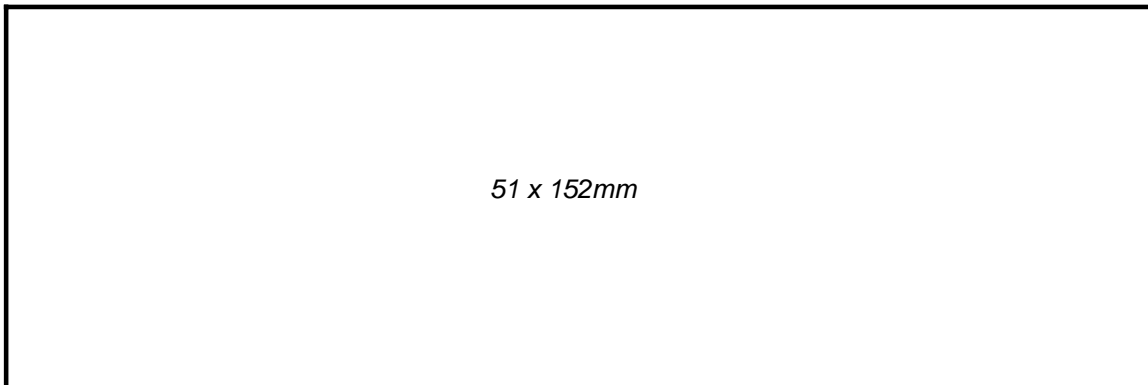
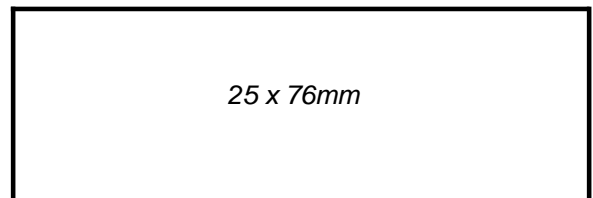
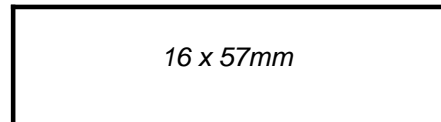
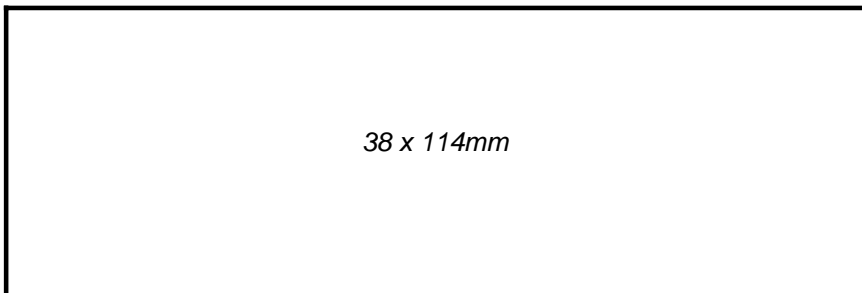

Fax Order Form

Customer Number	_____	Order Date	_____
Company Name	_____	Purchase Order	_____
Ship To Address	_____	Payment Terms	_____
	_____	Ship Via	_____

Contact Name	_____	Phone	_____
(print)	_____	Fax	_____

(Be sure to copy this blank form for future use.)

LINE NO.	KATUN PN	DESCRIPTION	QUANTITY ORDERED	UNIT PRICE	TOTAL AMOUNT
1					
2					
3					
4					
5					
6					
7					
8					
9					
10					
11					
12					
13					
14					
15					
16					
17					
18					
19					
20					

Fax-Bestellformular

Kunden-Nr.	_____	Bestelldatum	_____
Firma	_____	Bestell-Nr.	_____
Lieferanschrift	_____	Zahlungsbedingungen	_____
	_____	Versandart	_____



Name	_____	Telefon-Nr.	_____
(Bitte in Druckschrift)	_____	Fax-Nr.	_____

(Kopieren Sie dieses Blanko-Formular für zukünftige Bestellungen.)

POS.	KATUN ART.-NR	BESCHREIBUNG	MENGE	STÜCKPREIS	GESAMT-BETRAG
1					
2					
3					
4					
5					
6					
7					
8					
9					
10					
11					
12					
13					
14					
15					
16					
17					
18					
19					
20					

For use in
Sharp
Copiers







Central/Eastern Europe
Telephone: 31(0)183-696969
Fax: 31(0)183-629055
E-mail: order@edc.katun.com

OEM PN	KATUN PN	DESCRIPTION	MODEL NO.
Toners and Developers			
AL-80TD	45018534	Black TD Cartridge Original	AL 840, AL 841, AL F 880
AL-100TD	45017930	Copier Toner Cartridge Original 290 g / Assembly	AL 1000, AL 1200, AL 1551 CS, SN 1045
N/P/N	45021362 	Black Toner Kit 225 g / Bottle Includes: • (1) Pour Spout 10 Bottles per Master Carton	AL 1000, AL 1200, AR 122 E, AR 122 E N, AR 122 EN, AR 123 E, AR 151, AR 152 E, AR 152 E N, AR 153 E, AR 153 E N, AR 156, AR 157 E, AR 157 E N, AR 162, AR 163, AR 201, AR 206, AR 207, AR F 152, AR F 201 <i>Priced per Carton, 10 Bottles per Carton.</i>
AR-150LT	45021362 	Black Toner Kit 225 g / Bottle Includes: • (1) Pour Spout 10 Bottles per Master Carton	AR 120 E, AR 150, AR 150 E, AR F 151 <i>Priced per Carton, 10 Bottles per Carton.</i>
AR-152LD	45022037	Black Developer Original 170 g / Bag	AR 122 E, AR 122 E N, AR 122 EN, AR 123 E, AR 151, AR 152 E, AR 152 E N, AR 153 E, AR 153 E N, AR 156, AR 157 E, AR 157 E N, AR F 152
AR-152LT	45022036	Black Toner Cartridge Original 210 g / Cartridge	AR 122 E, AR 122 E N, AR 122 EN, AR 123 E, AR 151, AR 152 E, AR 152 E N, AR 153 E, AR 153 E N, AR 156, AR 157 E, AR 157 E N, AR F 152
AR-200LT	45018441 	Black Toner Refill Kit 610 g / Bottle Includes: • (3) Pour Spout 10 Bottles per Master Carton	AR 160, AR 161, AR 200, AR 200 S, AR 200 SE, AR 205 <i>Priced per Carton, 10 Bottles per Carton.</i>
AR-200LT	45018155	Black Toner Refill Kit Original 610 g / Cartridge • (1) Waste Toner Bottle	AR 160, AR 161, AR 200, AR 200 S, AR 200 SE, AR 205 <i>Priced per Cartridge, sold in Boxes of 10.</i>
AR-201DV	45021588	Black Developer Original 400 g / Bag	AR 162, AR 163, AR 201, AR 206, AR 207, AR F 201
AR-201FT	45023158	Black Toner Cartridge Original	AR 162, AR 163, AR 201, AR 206, AR 207, AR F 201
AR-202CD	45021588	Black Developer Original 400 g / Bag	AR 162, AR 163, AR 201, AR 207, AR M 160, AR M 205

You can personalize select Katun Performance products. See the front of the catalog for details. Already enrolled in the Personalized Product program? Just add 'P' to the Katun PN and order by the master carton.

OEM PN	KATUN PN	DESCRIPTION	MODEL NO.
-----------	-------------	-------------	--------------

Toners and Developers

AR-336LD	45017359	Black Developer Original 800 g / Bag	AR 250, AR 281, AR 286, AR 287, AR 335, AR 336, AR 337
AR-400LT	45017562 	Black Toner 700 g / Cartridge 10 Cartridges per Master Carton	AR 250, AR 281, AR 286, AR 287, AR 336, AR 337, AR 405, AR 407
AR-400LT	45018519 	Black Toner 700 g / Cartridge 10 Cartridges per Master Carton	AR 250, AR 281, AR 286, AR 287, AR 336, AR 337, AR 405, AR 407
AR-330LT	45017562 	Black Toner 700 g / Cartridge 10 Cartridges per Master Carton	AR 280, AR 285, AR 335
AR-330LT	45018519 	Black Toner 700 g / Cartridge 10 Cartridges per Master Carton	AR 280, AR 285, AR 335
AR-500LT	45018351 	Black Toner 700 g / Cartridge 10 Cartridges per Master Carton	AR 505, AR 507
AR-532LD1	45017683	Black Developer Original 850 g / Bag	AR 5125, AR 5132
AR-532LT1	45017681	Black Toner Original 600 g / Cartridge	AR 5125, AR 5132
AR-202ET	45023158	Black Toner Cartridge Original	AR M 160, AR M 205
SD-360DV1	45013588	Black Developer Original 1000 g / Bag	SD 2060, SD 3062
SD-360LD	45013588	Black Developer Original 1000 g / Bag	SD 2060, SD 3062, SF 2050, SF 2052
SD-360LT	45016904 	Black Toner 930 g / Cartridge 10 Cartridges per Master Carton	SD 2060, SD 3062, SF 2050, SF 2052
SD-360T	45013539	Black Toner Original 930 g / Cartridge	SD 2060, SD 3062, SF 2050, SF 2052
SD-365CD	45017356	Black Developer Original 850 g / Bag	SD 2260

*Priced per Carton,
10 Cartridges per Carton.*

*Priced per Cartridge,
sold per Cartridge.*

*Priced per Carton,
10 Cartridges per Carton.*

*Priced per Cartridge,
sold per Cartridge.*







*Priced per Carton,
10 Cartridges per Carton.*

*Priced per Carton,
10 Cartridges per Carton.*

You can personalize select Katun Performance products. See the front of the catalog for details. Already enrolled in the Personalized Product program? Just add 'P' to the Katun PN and order by the master carton.

For use in
Sharp
Copiers

Central/Eastern Europe
Telephone: 31(0)183-696969
Fax: 31(0)183-629055
E-mail: order@edc.katun.com

OEM PN	KATUN PN	DESCRIPTION	MODEL NO.
Toners and Developers			
SD-365DV	45017356	Black Developer Original 850 g / Bag	SD 2260
SD-365LD	45017356	Black Developer Original 850 g / Bag	SD 2260
SD-365LT	45016904 	Black Toner 930 g / Cartridge 10 Cartridges per Master Carton	SD 2260
SD-365LT	45017355	Black Toner Original 930 g / Cartridge	SD 2260
SF- 76LT	45808181 	Black Toner 200 g / Bottle 20 Bottles per Master Carton	SF 755, SF 756, SF 760, SF 7100
A3SF116LT	45014477 	Black Toner 240 g / Bottle 10 Bottles per Master Carton	SF 1016, SF 1018
SF-116T	45014477 	Black Toner 240 g / Bottle 10 Bottles per Master Carton	SF 1016, SF 1018, SF 1020, SF 1120
SF-125LT	45014472 	Black Toner 260 g / Bottle 1 Box (10 Bottles) per Master Carton	SF 1025
SF-222DV1	45013572	Black Developer Original 850 g / Bag	SF 1025, SF 2022, SF 2022 N, SF 2027, SF 2027 N
SF-126LT	45016681 	Black Toner 240 g / Bottle Includes One Toner Hopper Key 10 Bottles per Master Carton	SF 1116
SF-214LT1	45021512 	Black Toner 184 g / Bottle Refill Bottle 1 Box (10 Bottles) per Master Carton	SF 2014, SF 2114, SF 2214
SF-214T1	45013543	Black Toner Original 232 g / Cartridge	SF 2014, SF 2114, SF 2214
SF-216DV1	45013586	Black Developer Original 530 g / Bag	SF 2020, SF 2116, SF 2118, SF 2120

*Priced per Carton,
10 Cartridges per Carton.*

*Priced per Carton,
20 Bottles per Carton.*

*Priced per Carton,
10 Bottles per Carton.*

*Priced per Carton,
10 Bottles per Carton.*

*Priced per Carton,
10 Bottles per Carton.*

*Priced per Carton,
10 Bottles per Carton.*

*Priced per Carton,
10 Bottles per Carton.*

You can personalize select Katun Performance products. See the front of the catalog for details. Already enrolled in the Personalized Product program? Just add 'P' to the Katun PN and order by the master carton.



OEM PN	KATUN PN	DESCRIPTION	MODEL NO.
Toners and Developers			
SF-216LD1	45013586	Black Developer Original 530 g / Bag	SF 2020, SF 2116, SF 2118, SF 2120
SF-216LT1	45013249 	Black Toner 200 g / Cartridge 10 Cartridges per Master Carton	SF 2020, SF 2116, SF 2118, SF 2120
SF-216LT1	45013546	Black Toner Original 200 g / Cartridge	SF 2020, SF 2116, SF 2118, SF 2120
SF-222T1	45013461	Black Toner Original 320 g / Cartridge	SF 2022, SF 2022 N, SF 2027
SF-222DV1	45013262 	Black Developer 850 g / Bottle 10 Bottles per Master Carton	SF 2022, SF 2022 N, SF 2027, SF 2027 N
SF-222LD1	45012962 	Black Developer 850 g / Bottle 10 Bottles per Master Carton	SF 2022, SF 2022 N, SF 2027, SF 2027 N
SF-222LT1	45015363 	Black Toner 320 g / Cartridge 10 Cartridges per Master Carton	SF 2022, SF 2022 N, SF 2027, SF 2027 N
SF-230DV1	45018154	Black Developer Original 850 g / Bag	SF 2025, SF 2030, SF 2530
SF-230LT1	45013242 	Black Toner 600 g / Cartridge 10 Cartridges per Master Carton	SF 2025, SF 2030, SF 2530
SF-230T1	45015375	Black Toner Original 600 g / Cartridge	SF 2025, SF 2030, SF 2530
SF-235DV1	45013573	Black Developer Original 850 g / Bag	SF 2035
SF-235LD1	45013573	Black Developer Original 850 g / Bag	SF 2035
SF-235LT1	45015364 	Black Toner 320 g / Cartridge 10 Cartridges per Master Carton	SF 2035
SF-235LT1	45013542	Black Toner Original 320 g / Cartridge	SF 2035

*Priced per Carton,
10 Cartridges per Carton.*

*Priced per Bottle,
sold per Bottle.*

*Priced per Carton,
10 Bottles per Carton.*

*Priced per Carton,
10 Cartridges per Carton.*









*Priced per Carton,
10 Cartridges per Carton.*

*Priced per Carton,
10 Cartridges per Carton.*









You can personalize select Katun Performance products. See the front of the catalog for details. Already enrolled in the Personalized Product program? Just add 'P' to the Katun PN and order by the master carton.

For use in
Sharp
Copiers

Central/Eastern Europe
Telephone: 31(0)183-696969
Fax: 31(0)183-629055
E-mail: order@edc.katun.com

OEM PN	KATUN PN	DESCRIPTION	MODEL NO.
Toners and Developers			
SF-240LT1	45013242 	Black Toner 600 g / Cartridge 10 Cartridges per Master Carton	SF 2040, SF 2540 <i>Priced per Carton, 10 Cartridges per Carton.</i>
SF-240ST1	45015373	Black Toner Original 600 g / Cartridge	SF 2040, SF 2540
SF-226DV	45016870	Black Developer Original 530 g / Bag	SF 2216
SF-226LT	45016681 	Black Toner 240 g / Bottle Includes One Toner Hopper Key 10 Bottles per Master Carton	SF 2216, SF 2218, SF 2220, SF 2320 <i>Priced per Carton, 10 Bottles per Carton.</i>
SF-226LT	45018371 	Black Toner 240 g / Cartridge 10 Cartridges per Master Carton	SF 2216, SF 2218, SF 2220, SF 2320 <i>Priced per Carton, 10 Cartridges per Carton.</i>
SF-226LT	45016868	Black Toner Original 240 g / Cartridge	SF 2216, SF 2218, SF 2220, SF 2320
SF-226T	45019728 	Black Toner 240 g / Cartridge 10 Cartridges per Master Carton	SF 2216, SF 2218, SF 2220, SF 2320 <i>Priced per Cartridge, sold per Cartridge.</i>
SF-234DV	45016866	Black Developer Original 560 g / Bag	SF 2314, SF 2414, SF 2514
SF-234LT	45017246 	Black Toner 200 g / Cartridge 10 Cartridges per Master Carton	SF 2314, SF 2414, SF 2514 <i>Priced per Carton, 10 Cartridges per Carton.</i>
SF-234LT	45016865	Black Toner Original 200 g / Cartridge	SF 2314, SF 2414, SF 2514
N/P/N	45015567 	Black Toner 150 g / Bottle 10 Bottles per Master Carton	SF 6100, Z 50, Z 52, Z 55, Z 70, Z 72, Z 85, Z 85 II, Z 87, Z 88 <i>Priced per Carton, 10 Bottles per Carton.</i>
N/P/N	45015568 	Black Developer 200 g / Bottle 10 Bottles per Master Carton	SF 6100, Z 50, Z 52, Z 55, Z 70, Z 72, Z 85, Z 85 II, Z 87, Z 88 <i>Priced per Carton, 10 Bottles per Carton.</i>
SF-730CT1	45021513 	Black Toner 260 g / Bottle 10 Bottles per Master Carton	SF 7300, SF 7320, SF 7350, SF 7370 <i>Priced per Carton, 10 Bottles per Carton.</i>

You can personalize select Katun Performance products. See the front of the catalog for details. Already enrolled in the Personalized Product program? Just add 'P' to the Katun PN and order by the master carton.

OEM PN	KATUN PN	DESCRIPTION	MODEL NO.	
Toners and Developers				
SF-730CT1	45013329	Black Toner Original 260 g / Bottle	SF 7300, SF 7320, SF 7350, SF 7370	
SF-730LD1	45013356	Black Developer Original 400 g / Bag	SF 7300, SF 7320, SF 7350, SF 7370	
SF-770DV1	45818137 	Black Developer 800 g / Bottle 10 Bottles per Master Carton	SF 7700, SF 7750	<i>Priced per Bottle, sold per Bottle.</i>
SF-770MT1	45807831 	Black Toner 180 g / Bottle Includes: • (10) Waste Toner Bottle 10 Bottles per Master Carton	SF 7700, SF 7750	<i>Priced per Carton, 10 Bottles per Carton.</i>
SF-771LD1	45817804 	Black Developer 800 g / Bottle 10 Bottles per Master Carton	SF 7700, SF 7750	<i>Priced per Carton, 10 Bottles per Carton.</i>
SF-780CT1	45011359 	Black Toner 210 g / Cartridge 10 Cartridges per Master Carton	SF 7800, SF 7830, SF 7850	<i>Priced per Carton, 10 Cartridges per Carton.</i>
SF-780LD1	45013571	Black Developer Original 550 g / Bag	SF 7800, SF 7830, SF 7850	
SF-830CT1	45009715 	Black Toner 250 g / Cartridge 10 Cartridges per Master Carton	SF 7900, SF 8300, SF 8350, SF 8400	<i>Priced per Carton, 10 Cartridges per Carton.</i>
SF-830DV1	45012973 	Black Developer 600 g / Bottle 10 Bottles per Master Carton	SF 7900, SF 8300, SF 8350, SF 8400	<i>Priced per Bottle, sold per Bottle.</i>
SF-830LD1	45012858 	Black Developer 600 g / Bottle 10 Bottles per Master Carton	SF 7900, SF 8300, SF 8350, SF 8400	<i>Priced per Carton, 10 Bottles per Carton.</i>
SF-811CT1	45807826 	Black Toner 280 g / Bottle 10 Bottles per Master Carton	SF 8100, SF 8260	<i>Priced per Carton, 10 Bottles per Carton.</i>
SF-880CT1	45021514 	Black Toner 250 g / Bottle 20 Bottles per Master Carton	SF 8500, SF 8570, SF 8800, SF 8870	<i>Priced per Carton, 20 Bottles per Carton.</i>
SF-880CT1	45013350	Black Toner Original 250 g / Bottle	SF 8500, SF 8570, SF 8800, SF 8870	







You can personalize select Katun Performance products. See the front of the catalog for details. Already enrolled in the Personalized Product program? Just add 'P' to the Katun PN and order by the master carton.

For use in
Sharp
 Copiers

Central/Eastern Europe
 Telephone: 31(0)183-696969
 Fax: 31(0)183-629055
 E-mail: order@edc.katun.com

OEM PN	KATUN PN	DESCRIPTION	MODEL NO.
Toners and Developers			
ZT-20TD1	45013644	Black T/D Cartridge Original 950 g / Cartridge	Z 20, Z 21, Z 25, Z 26, Z 27
ZT-30DC1 <i>Final Inventory</i>	45013980	Black T/D Cartridge Original 988 g / Cartridge	Z 30
ZT-50DC1	45013698	Black T/D Cartridge Original 1140 g / Cartridge	Z 50, Z 52, Z 55, Z 70, Z 72, Z 85, Z 85 II, Z 87, Z 88
ZT-81TD1	45017939	Black T/D Cartridge Original	Z 810, Z 830, Z 845











You can personalize select Katun Performance products. See the front of the catalog for details. Already enrolled in the Personalized Product program? Just add 'P' to the Katun PN and order by the master carton.









OEM PN	KATUN PN	DESCRIPTION	MODEL NO.	
Photoreceptors				
AL-100DR	45017931	OPC Drum Cartridge Original	AL 1000, AL 1200, AL 1215, AL 1530 CS, AL 1540 CS, AL 1551 CS, SN 1045	
N/P/N	45019844 	Drum Cartridge Rebuild Kit Kit Contains: <ul style="list-style-type: none"> • (1) OPC Drum • (1) Drum Cleaning Blade • (1) Drum Fixing Plate • (1) Cleaning Unit F/R Side Seals 12 OPC Kits per Master Carton	AL 1000, AL 1200, AR 120 E, AR 150, AR 150 E, AR 151, AR 156, AR F 151, AR F 152, DM 1500, DM 1505	<i>Priced per OPC Kit, sold per OPC Kit.</i>
N/P/N	45018639 	OPC Drum Kit Kit Contains: <ul style="list-style-type: none"> • (1) OPC Drum • (1) Drum Fixing Plate 20 OPC Kits per Master Carton	AL 1000, AL 1200, DM 1500, DM 1505	<i>Priced per OPC Kit, sold per OPC Kit.</i>
AR-150LR	45018639 	OPC Drum Kit Kit Contains: <ul style="list-style-type: none"> • (1) OPC Drum • (1) Drum Fixing Plate 20 OPC Kits per Master Carton	AR 120 E, AR 150, AR 150 E, AR F 151	<i>Priced per OPC Kit, sold per OPC Kit.</i>
AR-152DM	45018639 	OPC Drum Kit Kit Contains: <ul style="list-style-type: none"> • (1) OPC Drum • (1) Drum Fixing Plate 20 OPC Kits per Master Carton	AR 121 E, AR 122 E, AR 122 E N, AR 122 EN, AR 123 E, AR 151, AR 152 E, AR 152 E N, AR 153 E, AR 153 E N, AR 156, AR 157 E, AR 157 E N, AR F 152	<i>Priced per OPC Kit, sold per OPC Kit.</i>
AR-152DR	45018639 	OPC Drum Kit Kit Contains: <ul style="list-style-type: none"> • (1) OPC Drum • (1) Drum Fixing Plate 20 OPC Kits per Master Carton	AR 122 E, AR 122 E N, AR 122 EN, AR 123 E, AR 151, AR 152 E, AR 152 E N, AR 153 E, AR 153 E N, AR 156, AR 157 E, AR 157 E N, AR 168 D, AR 168 S, AR F 152	<i>Priced per OPC Kit, sold per OPC Kit.</i>
AR-201DM	45017936 	OPC Drum Kit Kit Contains: <ul style="list-style-type: none"> • (1) OPC Drum • (1) Drum Fixing Plate 20 OPC Kits per Master Carton	AR 160, AR 161, AR 162, AR 163, AR 200, AR 200 S, AR 200 SE, AR 201, AR 205, AR 206, AR 207, AR F 201, DM 2000, DM 2005, DM 2010, DM 2015	<i>Priced per OPC Kit, sold per OPC Kit.</i>
AR-201DM	45023163	OPC Drum Kit Original	AR 160, AR 161, AR 162, AR 163, AR 200, AR 200 S, AR 200 SE, AR 201, AR 205, AR 206, AR 207, AR F 201, DM 2000, DM 2005, DM 2010, DM 2015	
AR-201DR	45017936 	OPC Drum Kit Kit Contains: <ul style="list-style-type: none"> • (1) OPC Drum • (1) Drum Fixing Plate 20 OPC Kits per Master Carton	AR 160, AR 161, AR 162, AR 163, AR 200, AR 200 S, AR 200 SE, AR 201, AR 205, AR 206, AR 207, AR F 201, DM 2000, DM 2005, DM 2010, DM 2015	<i>Priced per OPC Kit, sold per OPC Kit.</i>



For use in
Sharp
Copiers

Central/Eastern Europe
Telephone: 31(0)183-696969
Fax: 31(0)183-629055
E-mail: order@edc.katun.com







OEM PN	KATUN PN	DESCRIPTION	MODEL NO.	
Photoreceptors				
N/P/N	45019524 	Drum Cartridge Rebuild Kit Kit Contains: • (1) OPC Drum • (1) Drum Cleaning Blade • (1) Drum Fixing Plate • (1) Cleaning Unit F/R Side Seals 12 OPC Kits per Master Carton	AR 160, AR 161, AR 162, AR 163, AR 200, AR 200 S, AR 200 SE, AR 201, AR 205, AR 206, AR 207, AR F 201, DM 2000, DM 2005, DM 2010, DM 2015	<i>Priced per OPC Kit, sold per OPC Kit.</i>
AR-200DM	45018156	OPC Drum Cartridge Original	AR 160, AR 161, AR 200, AR 200 S, AR 200 SE, AR 205	
AR-200LR	45017936 	OPC Drum Kit Kit Contains: • (1) OPC Drum • (1) Drum Fixing Plate 20 OPC Kits per Master Carton	AR 160, AR 161, AR 200, AR 200 S, AR 200 SE, AR 205	<i>Priced per OPC Kit, sold per OPC Kit.</i>
AR-270DM	45021674 	OPC Drum 20 Drums per Master Carton	AR 235, AR 275	<i>Priced per Drum, sold per Drum.</i>
N/P/N	45021825 	OPC Drum Kit Kit Contains: • (1) OPC Drum • (1) Drum Cleaning Blade 12 OPC Kits per Master Carton	AR 235, AR 275	<i>Priced per OPC Kit, sold per OPC Kit.</i>
AR-336DM	45017933 	OPC Drum 12 Drums per Master Carton	AR 250, AR 280, AR 285, AR 286, AR 287, AR 335, AR 336, AR 337	<i>Priced per Drum, sold per Drum.</i>
AR-330DM	45017933 	OPC Drum 12 Drums per Master Carton	AR 280, AR 285, AR 335	<i>Priced per Drum, sold per Drum.</i>
AR-331DM	45017933 	OPC Drum 12 Drums per Master Carton	AR 281	<i>Priced per Drum, sold per Drum.</i>
AR-400DM	45017801 	OPC Drum 12 Drums per Master Carton	AR 405, AR 407	<i>Priced per Drum, sold per Drum.</i>
AR-500DM	45017935 	OPC Drum 12 Drums per Master Carton	AR 501, AR 505, AR 507	<i>Priced per Drum, sold per Drum.</i>
AR-810DM	45023019 	OPC Drum 460 K 500 K This drum is packaged for use in Toshiba, but is approved for use in these Sharp models. 6 Drums per Master Carton	AR 651 AR 810	<i>Priced per Drum, sold per Drum.</i>

OEM PN	KATUN PN	DESCRIPTION	MODEL NO.	
Photoreceptors				
AR-532DM	45017802 	OPC Drum 12 Drums per Master Carton	AR 5125, AR 5132	<i>Priced per Drum, sold per Drum.</i>
AR-C16DR	45023639 	OPC Drum Black 20 Drums per Master Carton	AR C 160, AR C 270	<i>Priced per Drum, sold per Drum.</i>
AR-202DM	45023163	OPC Drum Kit Original	AR M 160, AR M 205	
AR-271DM	45021674 	OPC Drum 20 Drums per Master Carton	AR M 236, AR M 237, AR M 276, AR M 277	<i>Priced per Drum, sold per Drum.</i>
AR-450DR	45021676 	OPC Drum 20 Drums per Master Carton	AR M 350, AR M 350 N, AR M 350 NB, AR M 350 U, AR M 350 UB, AR M 450, AR M 450 N, AR M 450 N+, AR M 450 NB, AR M 450 U, AR M 450 U+, AR M 450 UB	<i>Priced per Drum, sold per Drum.</i>
AR-451DM	45021676 	OPC Drum 20 Drums per Master Carton	AR M 350, AR M 450, AR M 450 N, AR M 450 N+, AR M 450 NB, AR M 450 U, AR M 450 U+, AR M 450 UB	<i>Priced per Drum, sold per Drum.</i>
SD-365DM	45015297 	OPC Drum 12 Drums per Master Carton	SD 2060, SD 2260, SD 3062	<i>Priced per Drum, sold per Drum.</i>
SF-216DM	45015434 	OPC Drum Kit Kit Contains: <ul style="list-style-type: none"> • (1) OPC Drum • (1) Drum Cleaning Blade • (2) Drum Picker Finger • (2) Drum Picker Finger Spring 12 OPC Kits per Master Carton	SF 1016, SF 1018, SF 1020, SF 1120, SF 2020, SF 2116, SF 2118, SF 2120	<i>Priced per OPC Kit, sold per OPC Kit.</i>
SF-222DM	45015845 	OPC Drum 12 Drums per Master Carton	SF 1025, SF 2022, SF 2027	<i>Priced per Drum, sold per Drum.</i>
SF-222DM	45015315	OPC Drum Access By Katun 12 Drums per Master Carton	SF 1025, SF 2022, SF 2027	<i>Priced per Drum, sold per Drum.</i>
SF-226DM	45016430 	OPC Drum Kit Kit Contains: <ul style="list-style-type: none"> • (1) OPC Drum • (1) Drum Cleaning Blade • (2) Drum Picker Finger 12 OPC Kits per Master Carton	SF 1116, SF 2216, SF 2218, SF 2220, SF 2320	<i>Priced per OPC Kit, sold per OPC Kit.</i>

For use in
Sharp
Copiers



Central/Eastern Europe
Telephone: 31(0)183-696969
Fax: 31(0)183-629055
E-mail: order@edc.katun.com

OEM PN	KATUN PN	DESCRIPTION	MODEL NO.	
Photoreceptors				
SF-214DK2	45012543 	OPC Drum Kit Kit Contains: • (1) OPC Drum • (1) Drum Cleaning Blade • (3) Screw 12 OPC Kits per Master Carton	SF 2014, SF 2114, SF 2214	<i>Priced per OPC Kit, sold per OPC Kit.</i>
SF-230DM	45014314 	OPC Drum 12 Drums per Master Carton	SF 2025, SF 2030, SF 2530	<i>Priced per Drum, sold per Drum.</i>
SF-230DM	45015374	OPC Drum Original	SF 2025, SF 2030, SF 2530	
SF-235DM	45015846 	OPC Drum 12 Drums per Master Carton	SF 2035	<i>Priced per Drum, sold per Drum.</i>
SF-240DM	45014315 	OPC Drum 12 Drums per Master Carton	SF 2040, SF 2540	<i>Priced per Drum, sold per Drum.</i>
SF-250DM	45012934 	OPC Drum 12 Drums per Master Carton	SF 2050, SF 2052	<i>Priced per Drum, sold per Drum.</i>
SF-234DM	45016672 	OPC Drum Kit Kit Contains: • (1) OPC Drum • (1) Drum Cleaning Blade 12 OPC Kits per Master Carton	SF 2314, SF 2414, SF 2514	<i>Priced per OPC Kit, sold per OPC Kit.</i>
N/P/N	45012768 	OPC Drum 12 Drums per Master Carton	SF 6100, Z 50, Z 52, Z 55, Z 70, Z 72, Z 85, Z 85 II, Z 87, Z 88	<i>Priced per Drum, sold per Drum.</i>
SF-730DR	45503720 	OPC Drum Kit Kit Contains: • (1) OPC Drum • (1) Drum Cleaning Blade • (1) Separation Tape 12 OPC Kits per Master Carton	SF 7300, SF 7320, SF 7350, SF 7370	<i>Priced per OPC Kit, sold per OPC Kit.</i>
SF-730DR	45017767	OPC Drum Kit Access By Katun Kit Contains: • (1) OPC Drum • (1) Separation Tape • (1) Drum Cleaning Blade 12 Drums per Master Carton	SF 7300, SF 7320, SF 7350, SF 7370	<i>Priced per Drum, sold per Drum.</i>
SF-770DR	45502779 	OPC Drum Kit Kit Contains: • (1) OPC Drum • (1) Drum Cleaning Blade 12 OPC Kits per Master Carton	SF 7700, SF 7750, SF 8100, SF 8260	<i>Priced per OPC Kit, sold per OPC Kit.</i>

OEM PN	KATUN PN	DESCRIPTION	MODEL NO.	
Photoreceptors				
SF-770DR <i>Final Inventory</i>	45013519	OPC Drum Kit Original Kit Contains: • (1) Drum Cleaning Blade • (1) OPC Drum	SF 7700, SF 7750, SF 8100, SF 8260	
SF-770DR	45009316	OPC Drum Kit Access By Katun Kit Contains: • (1) OPC Drum • (1) Drum Cleaning Blade 12 OPC Kits per Master Carton	SF 7700, SF 7750, SF 8100, SF 8260	<i>Priced per OPC Kit, sold per OPC Kit.</i>
SF-780DR	45000930 	OPC Drum Cartridge	SF 7800, SF 7830, SF 7850	
SF-780DR	45013518	OPC Drum Cartridge Original	SF 7800, SF 7830, SF 7850	
N/P/N	45010627 	OPC Drum Kit Kit Contains: • (1) OPC Drum • (1) Drum Cleaning Blade 12 Kits per Master Carton	SF 7800, SF 7830, SF 7850	<i>Priced per Kit, sold per Kit.</i>
SF-830DR	45502786 	OPC Drum 12 Drums per Master Carton	SF 7900, SF 8300, SF 8350, SF 8400, SF 8500, SF 8570, SF 8800, SF 8870	<i>Priced per Drum, sold per Drum.</i>
SF-970DR	45502753 	As2Se3 Drum 6 Drums per Master Carton	SF 9500, SF 9550, SF 9700, SF 9750, SF 9800	<i>Priced per Drum, sold per Drum.</i>
N/P/N	45015980 	OPC Drum 20 Drums per Master Carton	Z 30	<i>Priced per Drum, sold per Drum.</i>
ZT-81DR	45017374	OPC Drum Cartridge Original	Z 810, Z 830, Z 845	
N/P/N	45018577 	OPC Drum Kit Kit Contains: • (1) OPC Drum • (1) Drum Cleaning Blade 20 OPC Kits per Master Carton	Z 810, Z 830, Z 845	<i>Priced per OPC Kit, sold per OPC Kit.</i>

For use in
Sharp
 Copiers

Central/Eastern Europe
 Telephone: 31(0)183-696969
 Fax: 31(0)183-629055
 E-mail: order@edc.katun.com

OEM PN	KATUN PN	DESCRIPTION	MODEL NO.
Memory Upgrades			
N/P/N	45017668 	Memory Upgrade Board- 32 MB Printer Controller Memory	AR- PB 2
N/P/N <i>Final Inventory</i>	45017667 	Memory Upgrade Board- 16 MB Printer Controller Memory	AR- PB 2
N/P/N <i>Final Inventory</i>	45017665 	Memory Upgrade Board- 32 MB Printer Controller Memory	AR- PB 8

For current memory upgrade pricing, visit our on-line catalogue at www.katun.com or contact your customer service representative.

OEM PN	KATUN PN	DESCRIPTION	MODEL NO.
--------	----------	-------------	-----------

Parts for use in Sharp AL 1000, AL 1200

DWIR-0466CSZZ	45375548 	Corona Wire Spool 50 m / Spool 70µ Oxidized Transfer, Separation	AL 1000, AL 1200	
N/P/N	45019180 	Drum Cleaning Blade Includes: Front & Rear Side Seals	AL 1000, AL 1200	
41330 540600	45019610 	Lower Pressure Roller	AL 1000, AL 1200	
NROLR0028QSZZ	45019610 	Lower Pressure Roller	AL 1000, AL 1200	
NROLR0922FCZZ	45016478 	Manual Paper Feed Roller	AL 1000, AL 1200	
CGUMM0286FC31	45009690 	Manual Paper Feed Tire Tire Only	AL 1000, AL 1200	<i>Priced per Tire, sold in Bags of 10.</i>
CGUMM0288FC31	45014266 	Manual Paper Pickup Tire Tire Only	AL 1000, AL 1200	<i>Priced per Tire, sold in Bags of 10.</i>
CROLP0015QS01	45023035 	Paper Feed Roller Tire Only	AL 1000, AL 1200	<i>Priced per Tire, sold in Bags of 4.</i>
NROLI0014QSZZ	45015641 	Upper Fuser Roller OEM Type	AL 1000, AL 1200	
41330 533800	45020088 	Upper Fuser Roller Bushing	AL 1000, AL 1200	<i>Priced per Bushing, sold in Bags of 10.</i>
NBRGP0567FCZZ	45020088 	Upper Fuser Roller Bushing	AL 1000, AL 1200	<i>Priced per Bushing, sold in Bags of 10.</i>

Parts for use in Sharp AL F 880















NROLZ7051XCZZ	45016478 	Paper Feed Roller	AL F 880	
---------------	---	--------------------------	----------	--

Parts for use in Sharp AR 120 E, AR 121 E, AR 150, AR 150 E, AR 151, AR 151 E, AR 156, AR F 151, AR F 152











AR-150CB	45020845 	Cleaning Blade Kit	AR 120 E, AR 150, AR 150 E, AR F 151	<i>Priced per Kit, 10 Blades per Kit.</i>
----------	---	---------------------------	--------------------------------------	---

For use in
Sharp
Copiers



Central/Eastern Europe
Telephone: 31(0)183-696969
Fax: 31(0)183-629055
E-mail: order@edc.katun.com

OEM PN	KATUN PN	DESCRIPTION	MODEL NO.
Parts for use in Sharp AR 120 E, AR 121 E, AR 150, AR 150 E, AR 151, AR 151 E, AR 156, AR F 151, AR F 152			
DWIR-0466CSZZ	45375548 	Corona Wire Spool 50 m / Spool 70µ Oxidized Transfer, Separation	AR 120 E, AR 121 E, AR 150, AR 150 E, AR 151, AR 151 E, AR 156, AR F 151, AR F 152
MSPRT0513FCZZ	45524654 	Corona Wire Spring Stainless Steel Various Applications	AR 121 E, AR 151, AR 151 E, AR 156, AR F 152 <i>Priced per Spring, sold in Bags of 10.</i>
N/P/N	45019180 	Drum Cleaning Blade Includes: Front & Rear Side Seals	AR 120 E, AR 150, AR 150 E, AR F 151
UCLEZ0013QSZZ	45019180 	Drum Cleaning Blade Includes: Front & Rear Side Seals	AR 121 E, AR 151, AR 151 E, AR 156, AR F 152
41330 540600	45019610 	Lower Pressure Roller	AR F 151
NROLR0028QSZZ	45019610 	Lower Pressure Roller	AR 120 E, AR 121 E, AR 150, AR 150 E, AR 151, AR 151 E, AR 156, AR F 151, AR F 152
NROLR0922FCZZ	45016478 	Manual Paper Feed Roller	AR 120 E, AR 121 E, AR 150, AR 150 E, AR 151, AR 151 E, AR 156, AR F 151, AR F 152
CGUMM0286FC31	45009690 	Manual Paper Feed Tire Tire Only	AR 150, AR F 151 <i>Priced per Tire, sold in Bags of 10.</i>
CGUMM0288FC31	45014266 	Manual Paper Pickup Tire Tire Only	AR 150, AR F 151 <i>Priced per Tire, sold in Bags of 10.</i>
CROLP0015QS01	45023035 	Paper Feed Roller Tire Only	AR 120 E, AR 121 E, AR 150, AR 150 E, AR F 151, AR F 152 <i>Priced per Tire, sold in Bags of 4.</i>
NROLI0014QSZ2	45015641 	Upper Fuser Roller OEM Type	AR 120 E, AR 150, AR 150 E, AR F 151
NROLI0014QSZZ	45015641 	Upper Fuser Roller OEM Type	AR 121 E, AR 151, AR 151 E, AR 156, AR F 152
41330 533800	45020088 	Upper Fuser Roller Bushing	AR F 151 <i>Priced per Bushing, sold in Bags of 10.</i>
NBRGP0567FCZZ	45020088 	Upper Fuser Roller Bushing	AR 120 E, AR 121 E, AR 150, AR 150 E, AR 151, AR 151 E, AR 156, AR F 151, AR F 152 <i>Priced per Bushing, sold in Bags of 10.</i>

















OEM PN	KATUN PN	DESCRIPTION	MODEL NO.	
Parts for use in Sharp AR 122 E, AR 122 E N, AR 123 E, AR 152 E, AR 152 E N, AR 153 E, AR 153 E N, AR 157 E, AR 157 E N				
DWIR-0466CSZZ	45375548 	Corona Wire Spool 50 m / Spool 70µ Oxidized Transfer, Separation	AR 122 E, AR 122 E N, AR 123 E, AR 152 E, AR 152 E N, AR 153 E, AR 153 E N, AR 157 E, AR 157 E N	
6LA58 639600	45019180 	Drum Cleaning Blade Includes: Front & Rear Side Seals	AR 122 E, AR 122 E N, AR 123 E, AR 153 E, AR 153 E N	
N/P/N	45019180 	Drum Cleaning Blade Includes: Front & Rear Side Seals	AR 123 E, AR 153 E, AR 153 E N, AR 157 E, AR 157 E N	
41330 540600	45019610 	Lower Pressure Roller	AR 122 E, AR 122 E N, AR 123 E, AR 153 E, AR 153 E N	
NROLR0028QSZZ	45019610 	Lower Pressure Roller	AR 122 E, AR 122 E N, AR 123 E, AR 152 E, AR 152 E N, AR 153 E, AR 153 E N, AR 157 E, AR 157 E N	
NROLR0922FCZZ	45016478 	Manual Paper Feed Roller	AR 123 E, AR 153 E, AR 153 E N, AR 157 E, AR 157 E N	
CROLP0015QS01	45023035 	Paper Feed Roller Tire Only	AR 122 E, AR 122 E N, AR 123 E, AR 152 E, AR 152 E N, AR 153 E, AR 153 E N, AR 157 E, AR 157 E N	<i>Priced per Tire, sold in Bags of 4.</i>
NROLI0014QSZ3	45015641 	Upper Fuser Roller OEM Type	AR 122 E, AR 122 E N, AR 123 E, AR 152 E, AR 152 E N, AR 153 E, AR 153 E N, AR 157 E, AR 157 E N	
41330 533800	45020088 	Upper Fuser Roller Bushing	AR 122 E, AR 122 E N, AR 123 E, AR 153 E, AR 153 E N	<i>Priced per Bushing, sold in Bags of 10.</i>
NBRGP0567FCZZ	45020088 	Upper Fuser Roller Bushing	AR 122 E, AR 122 E N, AR 123 E, AR 152 E, AR 152 E N, AR 153 E, AR 153 E N, AR 157 E, AR 157 E N	<i>Priced per Bushing, sold in Bags of 10.</i>

Parts for use in Sharp AR 122 EN

DWIR-0466CSZZ	45375548 	Corona Wire Spool 50 m / Spool 70µ Oxidized Transfer, Separation	AR 122 EN
6LA58 639600	45019180 	Drum Cleaning Blade Includes: Front & Rear Side Seals	AR 122 EN

For use in
Sharp
Copiers

Central/Eastern Europe
Telephone: 31(0)183-696969
Fax: 31(0)183-629055
E-mail: order@edc.katun.com

OEM PN	KATUN PN	DESCRIPTION	MODEL NO.	
Parts for use in Sharp AR 122 EN				
41330 540600	45019610 	Lower Pressure Roller	AR 122 EN	
NROLR0028QSZZ	45019610 	Lower Pressure Roller	AR 122 EN	
CROLP0015QS01	45023035 	Paper Feed Roller Tire Only	AR 122 EN	<i>Priced per Tire, sold in Bags of 4.</i>
NROLI0014QSZ3	45015641 	Upper Fuser Roller OEM Type	AR 122 EN	
41330 533800	45020088 	Upper Fuser Roller Bushing	AR 122 EN	<i>Priced per Bushing, sold in Bags of 10.</i>
NBRGP0567FCZZ	45020088 	Upper Fuser Roller Bushing	AR 122 EN	<i>Priced per Bushing, sold in Bags of 10.</i>
Parts for use in Sharp AR 160, AR 161, AR 200, AR 200 S, AR 200 SE, AR 205				
AR-200CB	45019531 	Cleaning Blade Kit Includes: Front & Rear Side Seals	AR 160, AR 161, AR 200, AR 200 S, AR 200 SE, AR 205	<i>Priced per Kit, 10 Blades per Kit.</i>
DWIR-0466CSZZ	45375548 	Corona Wire Spool 50 m / Spool 70µ Oxidized Transfer, Separation	AR 160, AR 161, AR 200, AR 205	
UCLEZ0009QSZ1	45017810 	Drum Cleaning Blade	AR 160, AR 161, AR 200, AR 200 S, AR 200 SE, AR 205	
NROLR0031QSZZ	45018363 	Lower Pressure Roller MICROSLEEVE™	AR 160, AR 161	
NROLR0031QSZ1	45019860 	Lower Pressure Roller MICROSLEEVE™	AR 200, AR 200 S, AR 200 SE, AR 205	
NROLR0922FCZZ	45016478 	Manual Paper Feed Roller	AR 160, AR 161, AR 200, AR 200 S, AR 200 SE, AR 205	
CGUMM0286FC31	45009690 	Manual Paper Feed Tire Tire Only	AR 160, AR 161, AR 200, AR 200 S, AR 200 SE, AR 205	<i>Priced per Tire, sold in Bags of 10.</i>
CGUMM0288FC31	45014266 	Manual Paper Pickup Tire Tire Only	AR 160, AR 161, AR 200, AR 200 S, AR 200 SE, AR 205	<i>Priced per Tire, sold in Bags of 10.</i>
CROLP1115FC01	45014266 	Manual Pickup Roller Tire Only	AR 160, AR 161, AR 200, AR 200 S, AR 200 SE, AR 205	<i>Priced per Tire, sold in Bags of 10.</i>

















Katun Performance Product

© 2004 Katun Corporation

26 October 2004

For the most current product and pricing information, visit the Katun On-Line Catalog at www.katun.com.















Prices, terms and conditions are subject to change without notice.

OEM PN	KATUN PN	DESCRIPTION	MODEL NO.	
Parts for use in Sharp AR 160, AR 161, AR 200, AR 200 S, AR 200 SE, AR 205				
PGUMM0012QSZZ	45022795 	Paper Feed Tire Green Tire For PN:CSFTZ0066RS71	AR 160, AR 161, AR 200, AR 200 S, AR 200 SE, AR 205	<i>Priced per Tire, sold in Bags of 10.</i>
AR-160UH	45018350 	Upper Fuser Roller	AR 160, AR 161, AR 200, AR 200 S, AR 200 SE, AR 205	
NROLI0030QSZZ	45018350 	Upper Fuser Roller	AR 160, AR 161, AR 200, AR 200 S, AR 200 SE, AR 205	
NBRGP0567FCZZ	45020088 	Upper Fuser Roller Bushing	AR 160, AR 161, AR 200, AR 200 S, AR 200 SE, AR 205	<i>Priced per Bushing, sold in Bags of 10.</i>
Parts for use in Sharp AR 162, AR 163, AR 201, AR 206, AR 207, AR F 201				
AR-200CB	45019531 	Cleaning Blade Kit Includes: Front & Rear Side Seals	AR 162, AR 163, AR 201, AR 206, AR 207	<i>Priced per Kit, 10 Blades per Kit.</i>
DWIR-0466CSZZ	45375548 	Corona Wire Spool 50 m / Spool 70µ Oxidized Transfer, Separation	AR 162, AR 163, AR 201, AR 206, AR 207, AR F 201	
UCLEZ0009QSZ1	45017810 	Drum Cleaning Blade	AR 162, AR 163, AR 201, AR 206, AR 207, AR F 201	
NROLR0031QSZ1	45019860 	Lower Pressure Roller MICROSLEEVE™	AR 162, AR 163, AR 201, AR 206, AR 207, AR F 201	
NROLR0922FCZZ	45016478 	Manual Paper Feed Roller	AR 162, AR 163, AR 201, AR 206, AR 207, AR F 201	
CROLP1115FC01	45014266 	Manual Pickup Roller Tire Only	AR 162, AR 163, AR 201, AR 206, AR 207, AR F 201	<i>Priced per Tire, sold in Bags of 10.</i>
PGUMM0012QSZZ	45022795 	Paper Feed Tire Green Tire For PN:CSFTZ0066RS71	AR 162, AR 163, AR 201, AR 206, AR 207, AR F 201	<i>Priced per Tire, sold in Bags of 10.</i>
AR-160UH	45018350 	Upper Fuser Roller	AR 163, AR 207	
NROLI0030QSZZ	45018350 	Upper Fuser Roller	AR 162, AR 163, AR 201, AR 206, AR 207, AR F 201	
NBRGP0567FCZZ	45020088 	Upper Fuser Roller Bushing	AR 162, AR 163, AR 201, AR 206, AR 207, AR F 201	<i>Priced per Bushing, sold in Bags of 10.</i>



For use in
Sharp
Copiers











Central/Eastern Europe
Telephone: 31(0)183-696969
Fax: 31(0)183-629055
E-mail: order@edc.katun.com

OEM PN	KATUN PN	DESCRIPTION	MODEL NO.
Parts for use in Sharp AR 168 D			
DWIR-0466CSZZ	45375548 	Corona Wire Spool 50 m / Spool 70µ Oxidized Transfer, Separation	AR 168 D
UCLEZ0013QSZZ	45019180 	Drum Cleaning Blade Includes: Front & Rear Side Seals	AR 168 D
NROLR0028QSZZ	45019610 	Lower Pressure Roller	AR 168 D
PGUMM0012QSZZ	45022795 	Paper Feed Tire Green Tire For PN:CSFTZ0066RS71	AR 168 D
NROLI0014QSZ3	45015641 	Upper Fuser Roller OEM Type	AR 168 D
NBRGP0567FCZZ	45020088 	Upper Fuser Roller Bushing	AR 168 D
<i>Priced per Tire, sold in Bags of 10.</i>			
<i>Priced per Bushing, sold in Bags of 10.</i>			
Parts for use in Sharp AR 168 S			
DWIR-0466CSZZ	45375548 	Corona Wire Spool 50 m / Spool 70µ Oxidized Transfer, Separation	AR 168 S
UCLEZ0013QSZZ	45019180 	Drum Cleaning Blade Includes: Front & Rear Side Seals	AR 168 S
NROLR0028QSZZ	45019610 	Lower Pressure Roller	AR 168 S
PGUMM0012QSZZ	45022795 	Paper Feed Tire Green Tire For PN:CSFTZ0066RS71	AR 168 S
NROLI0014QSZ3	45015641 	Upper Fuser Roller OEM Type	AR 168 S
NBRGP0567FCZZ	45020088 	Upper Fuser Roller Bushing	AR 168 S
<i>Priced per Tire, sold in Bags of 10.</i>			
<i>Priced per Bushing, sold in Bags of 10.</i>			
Parts for use in Sharp AR 235, AR 275			
AR-270CB	45020916 	Cleaning Blade Kit	AR 235, AR 275
<i>Priced per Kit, 10 Blades per Kit.</i>			
UCLEZ0011QSZZ	45020915 	Drum Cleaning Blade	AR 235, AR 275
NBRGY0022QSZZ	45015954 	Lower Fuser Roller Bearing	AR 235, AR 275

















Katun Performance Product

© 2004 Katun Corporation

















OEM PN	KATUN PN	DESCRIPTION	MODEL NO.
Parts for use in Sharp AR 235, AR 275			
NROLR0083QSZZ	45021694 	Lower Pressure Roller	AR 235, AR 275
NROLR1051FCZZ	45012886 	Manual Paper Feed Roller Tire Only	AR 235, AR 275 <i>Priced per Tire, sold in Bags of 10.</i>
NROLR0053QSZZ	45021697 	Upper Fuser Roller	AR 235, AR 275
Parts for use in Sharp AR 250, AR 286, AR 336			
AR-330KB	45022595 	160K PM Kit Kit Contains: <ul style="list-style-type: none"> • (1) Upper Fuser Roller Gear • (1) Upper Fuser Roller • (1) Developer Unit Seal • (1) Lower Pressure Roller • (1) Toner Reception Seal 	AR 250, AR 286, AR 336
AR-400KB	45022596 	180K PM Kit Kit Contains: <ul style="list-style-type: none"> • (1) Upper Fuser Roller Gear • (1) Upper Fuser Roller • (1) Developer Unit Seal • (1) Lower Pressure Roller • (1) Toner Reception Seal 	AR 336
AR-330KA	45018881 	80K PM Kit Kit Contains: <ul style="list-style-type: none"> • (1) Drum Cleaning Blade • (1) Charge Plate Assembly • (2) Drum Picker Finger • (2) Waste Toner Bottle • (4) Upper Picker Finger • (2) Lower Picker Finger • (1) Corona Screen Grid 	AR 250, AR 286, AR 336
AR-400KA	45018881 	90k PM KIT Kit Contains: <ul style="list-style-type: none"> • (1) Drum Cleaning Blade • (1) Charge Plate Assembly • (2) Drum Picker Finger • (2) Waste Toner Bottle • (4) Upper Picker Finger • (2) Lower Picker Finger • (1) Corona Screen Grid 	AR 250, AR 286, AR 336
NBRGY0093FCZZ	45576205 	Bearing Various Applications	AR 250, AR 286, AR 336
NBRGY0131FCZZ	45576204 	Bearing Various Applications	AR 250, AR 286, AR 336
NBRGY0466FCZZ	45576233 	Bearing Various Applications	AR 250, AR 286, AR 336

For use in
Sharp
Copiers

Central/Eastern Europe
Telephone: 31(0)183-696969
Fax: 31(0)183-629055
E-mail: order@edc.katun.com













OEM PN	KATUN PN	DESCRIPTION	MODEL NO.
Parts for use in Sharp AR 250, AR 286, AR 336			
NBRGY0599FCZZ	45576217 	Bearing	AR 250, AR 286, AR 336
AR-330CB	45020066 	Cleaning Blade Kit	AR 250, AR 286, AR 336 <i>Priced per Kit, 10 Blades per Kit.</i>
AR-330TU	45018554 	Corona Screen Grid	AR 250, AR 286, AR 336
LPLTM5393FCZZ	45018554 	Corona Screen Grid	AR 250, AR 286, AR 336
DWIR-0466CSZZ	45375548 	Corona Wire Spool 50 m / Spool 70µ Oxidized Charge	AR 250, AR 286, AR 336
DWIR-0550CSZZ	45375120 	Corona Wire Spool 50 m / Spool 60µ 0.3µ Gold Plated Transfer, Separation	AR 336
MSPRT0513FCZZ	45524654 	Corona Wire Spring Stainless Steel Various Applications	AR 250, AR 286, AR 336 <i>Priced per Spring, sold in Bags of 10.</i>
PSHEP4617FCZZ	45018032 	Developer Unit Seal	AR 250, AR 286, AR 336
AR-330BL	45018036 	Drum Cleaning Blade	AR 250, AR 286, AR 336
UCLEZ0149FCZ1	45018036 	Drum Cleaning Blade	AR 250, AR 286, AR 336
CDAIU0451FC51	45020110 	Drum Picker Finger Assembly	AR 250, AR 286 <i>Priced per Picker Finger, sold in Packages of 2.</i>
CDAIU0451FC52	45020110 	Drum Picker Finger Assembly	AR 336 <i>Priced per Picker Finger, sold in Packages of 2.</i>
N/P/N	45019752 	Feed Roller Replacement Kit New Style Kit Contains: • (1) Paper Feed Roller • (1) Paper Pickup Roller • (1) Reverse Roller	AR 250, AR 286, AR 336
LBSHZ0330FCZZ	45012446 	Heat Insulating Sleeve	AR 250, AR 286, AR 336 <i>Priced per Heat Sleeve, sold in Bags of 10.</i>



OEM PN	KATUN PN	DESCRIPTION	MODEL NO.
Parts for use in Sharp AR 250, AR 286, AR 336			
SF-240DU	45012446 	Heat Insulating Sleeve	AR 250, AR 286, AR 336
			<i>Priced per Heat Sleeve, sold in Bags of 10.</i>
PTME-0174FCZ1	45018041 	Lower Picker Finger	AR 250, AR 286, AR 336
			<i>Priced per Picker Finger, sold in Boxes of 10.</i>
AR-330HR	45018283 	Lower Pressure Roller MICROSLEEVE™	AR 250, AR 286, AR 336
NROLI1206FCZZ	45018283 	Lower Pressure Roller MICROSLEEVE™	AR 250, AR 286, AR 336
AR-330LH	45017526 	Lower Pressure Roller Kit Kit Contains: • (1) Lower Pressure Roller MICROSLEEVE™ • (2) Lower Picker Finger	AR 250, AR 286, AR 336
NROLR1241FCZZ	45021483 	Manual Paper Feed Roller Tire Only	AR 250, AR 286, AR 336
			<i>Priced per Tire, sold in Bags of 10.</i>
NROLR1240FCZZ	45021458 	Manual Pickup Roller Tire Only	AR 250, AR 286, AR 336
			<i>Priced per Tire, sold in Bags of 10.</i>
NROLR1220FCZZ	45021479 	Manual Reverse Roller Tire Only	AR 250, AR 286, AR 336
			<i>Priced per Tire, sold in Bags of 10.</i>
AR-330JL	45018864 	Ozone Filter	AR 250, AR 286, AR 336
PFILZ0265FCZ1	45018864 	Ozone Filter	AR 250, AR 286, AR 336
NROLR1218FCZZ	45018450 	Paper Feed Roller	AR 250, AR 286, AR 336
NROLR1219FCZZ	45018451 	Paper Pickup Roller	AR 250, AR 286, AR 336
NROLR1219FCZZ	45021458 	Paper Pickup Roller Tire Only	AR 250, AR 286, AR 336
			<i>Priced per Tire, sold in Bags of 10.</i>
NROLR1229FCZZ	45018452 	Reverse Roller	AR 250, AR 286, AR 336
RDTCT0134FCZZ	45017285 	Thermistor Main	AR 250, AR 286, AR 336
RDTCT0135FCZZ	45017286 	Thermistor Sub	AR 250, AR 286, AR 336
UCLEZ0158FCZZ	45019959 	Toner Reception Seal	AR 250, AR 336

For use in
Sharp
Copiers

Central/Eastern Europe
Telephone: 31(0)183-696969
Fax: 31(0)183-629055
E-mail: order@edc.katun.com

OEM PN	KATUN PN	DESCRIPTION	MODEL NO.
Parts for use in Sharp AR 250, AR 286, AR 336			
AR-330HU	45016803 	Upper Fuser Roller OEM Type	AR 250, AR 286, AR 336
NGERH1214FCZZ	45012819 	Upper Fuser Roller Gear	AR 250, AR 286, AR 336
AR-330UH	45016918 	Upper Fuser Roller Kit Kit Contains: <ul style="list-style-type: none"> • (1) Upper Fuser Roller REVOLUTION™ • (1) Upper Fuser Roller Gear • (4) Upper Picker Finger 	AR 250, AR 286, AR 336
PTME-0168FCZZ	45013096 	Upper Picker Finger	AR 250, AR 286, AR 336
PRNGP0015FCZZ	45012311 	V Ring	AR 250, AR 286, AR 336
AR-330TB	45017921 	Waste Toner Bottle	AR 250, AR 286, AR 336
CYOK-0053FC01	45017921 	Waste Toner Bottle	AR 250, AR 286, AR 336
Parts for use in Sharp AR 280, AR 285, AR 335			
AR-330KB	45022595 	160K PM Kit Kit Contains: <ul style="list-style-type: none"> • (1) Upper Fuser Roller Gear • (1) Upper Fuser Roller • (1) Developer Unit Seal • (1) Lower Pressure Roller • (1) Toner Reception Seal 	AR 280, AR 285, AR 335
AR-330KA	45018881 	80K PM Kit Kit Contains: <ul style="list-style-type: none"> • (1) Drum Cleaning Blade • (1) Charge Plate Assembly • (2) Drum Picker Finger • (2) Waste Toner Bottle • (4) Upper Picker Finger • (2) Lower Picker Finger • (1) Corona Screen Grid 	AR 280, AR 285, AR 335
NBRGY0093FCZZ	45576205 	Bearing Various Applications	AR 280, AR 285, AR 335
NBRGY0131FCZZ	45576204 	Bearing Various Applications	AR 280, AR 285, AR 335
NBRGY0466FCZZ	45576233 	Bearing Various Applications	AR 280, AR 285, AR 335
NBRGY0599FCZZ	45576217 	Bearing	AR 280, AR 285, AR 335

*Priced per Picker Finger,
sold in Packages of 10.*

*Priced per Bag,
4 Seals per Bag.*



















Katun Performance Product

© 2004 Katun Corporation

OEM PN	KATUN PN	DESCRIPTION	MODEL NO.
Parts for use in Sharp AR 280, AR 285, AR 335			
AR-330CB	45020066 	Cleaning Blade Kit	AR 280, AR 285, AR 335
			<i>Priced per Kit, 10 Blades per Kit.</i>
AR-330TU	45018554 	Corona Screen Grid	AR 280, AR 285, AR 335
LPLTM5393FCZZ	45018554 	Corona Screen Grid	AR 280, AR 285, AR 335
DWIR-0466CSZZ	45375548 	Corona Wire Spool 50 m / Spool 70µ Oxidized Charge	AR 280, AR 285, AR 335
MSPRT0513FCZZ	45524654 	Corona Wire Spring Stainless Steel Various Applications	AR 280, AR 285, AR 335
			<i>Priced per Spring, sold in Bags of 10.</i>
PSHEP4617FCZZ	45018032 	Developer Unit Seal	AR 280, AR 285, AR 335
AR-330BL	45018036 	Drum Cleaning Blade	AR 280, AR 285, AR 335
UCLEZ0149FCZ1	45018036 	Drum Cleaning Blade	AR 280, AR 285, AR 335
CDAIU0451FC51	45020110 	Drum Picker Finger Assembly	AR 280, AR 285, AR 335
			<i>Priced per Picker Finger, sold in Packages of 2.</i>
N/P/N	45019752 	Feed Roller Replacement Kit New Style Kit Contains: • (1) Paper Feed Roller • (1) Paper Pickup Roller • (1) Reverse Roller	AR 280, AR 285, AR 335
LBSHZ0330FCZZ	45012446 	Heat Insulating Sleeve	AR 280, AR 285, AR 335
			<i>Priced per Heat Sleeve, sold in Bags of 10.</i>
SF-240DU	45012446 	Heat Insulating Sleeve	AR 280, AR 285, AR 335
			<i>Priced per Heat Sleeve, sold in Bags of 10.</i>
PTME-0174FCZ1	45018041 	Lower Picker Finger	AR 280, AR 285, AR 335
			<i>Priced per Picker Finger, sold in Boxes of 10.</i>
AR-330HR	45018283 	Lower Pressure Roller MICROSLEEVE™	AR 280, AR 285, AR 335
NROLI1206FCZZ	45018283 	Lower Pressure Roller MICROSLEEVE™	AR 280, AR 285, AR 335

For use in
Sharp
Copiers











Central/Eastern Europe
Telephone: 31(0)183-696969
Fax: 31(0)183-629055
E-mail: order@edc.katun.com

OEM PN	KATUN PN	DESCRIPTION	MODEL NO.
Parts for use in Sharp AR 280, AR 285, AR 335			
AR-330LH	45017526 	Lower Pressure Roller Kit Kit Contains: • (1) Lower Pressure Roller MICROSLEEVE™ • (2) Lower Picker Finger	AR 280, AR 285, AR 335
NROLR1241FCZZ	45021483 	Manual Paper Feed Roller Tire Only	AR 280, AR 285, AR 335 <i>Priced per Tire, sold in Bags of 10.</i>
NROLR1240FCZZ	45021458 	Manual Pickup Roller Tire Only	AR 280, AR 285, AR 335 <i>Priced per Tire, sold in Bags of 10.</i>
NROLR1220FCZZ	45021479 	Manual Reverse Roller Tire Only	AR 280, AR 285, AR 335 <i>Priced per Tire, sold in Bags of 10.</i>
AR-330JL	45018864 	Ozone Filter	AR 280, AR 285, AR 335
PFILZ0265FCZ1	45018864 	Ozone Filter	AR 280, AR 285, AR 335
NROLR1218FCZZ	45018450 	Paper Feed Roller	AR 280, AR 285, AR 335
NROLR1219FCZZ	45018451 	Paper Pickup Roller	AR 280, AR 285, AR 335
NROLR1219FCZZ	45021458 	Paper Pickup Roller Tire Only	AR 280, AR 285, AR 335 <i>Priced per Tire, sold in Bags of 10.</i>
NROLR1229FCZZ	45018452 	Reverse Roller	AR 280, AR 285, AR 335
RDTCT0134FCZZ	45017285 	Thermistor Main	AR 280, AR 285, AR 335
RDTCT0135FCZZ	45017286 	Thermistor Sub	AR 280, AR 285, AR 335
UCLEZ0158FCZZ	45019959 	Toner Reception Seal	AR 280, AR 285, AR 335
AR-330HU	45016803 	Upper Fuser Roller OEM Type	AR 280, AR 285, AR 335
NGERH1214FCZZ	45012819 	Upper Fuser Roller Gear	AR 280, AR 285, AR 335
AR-330UH	45016918 	Upper Fuser Roller Kit Kit Contains: • (1) Upper Fuser Roller REVOLUTION™ • (1) Upper Fuser Roller Gear • (4) Upper Picker Finger	AR 280, AR 285, AR 335



Katun Performance Product

© 2004 Katun Corporation

















OEM PN	KATUN PN	DESCRIPTION	MODEL NO.
Parts for use in Sharp AR 280, AR 285, AR 335			
PTME-0168FCZZ	45013096 	Upper Picker Finger	AR 280, AR 285, AR 335
			<i>Priced per Picker Finger, sold in Packages of 10.</i>
PRNGP0015FCZZ	45012311 	V Ring	AR 280, AR 285, AR 335
			<i>Priced per Bag, 4 Seals per Bag.</i>
AR-330TB	45017921 	Waste Toner Bottle	AR 280, AR 285, AR 335
CYOK-0053FC01	45017921 	Waste Toner Bottle	AR 280, AR 285, AR 335
Parts for use in Sharp AR 281			
AR-330KB	45022595 	160K PM Kit Kit Contains: <ul style="list-style-type: none"> • (1) Upper Fuser Roller Gear • (1) Upper Fuser Roller • (1) Developer Unit Seal • (1) Lower Pressure Roller • (1) Toner Reception Seal 	AR 281
AR-330KA	45018881 	80K PM Kit Kit Contains: <ul style="list-style-type: none"> • (1) Drum Cleaning Blade • (1) Charge Plate Assembly • (2) Drum Picker Finger • (2) Waste Toner Bottle • (4) Upper Picker Finger • (2) Lower Picker Finger • (1) Corona Screen Grid 	AR 281
AR-400KA	45018881 	90k PM KIT Kit Contains: <ul style="list-style-type: none"> • (1) Drum Cleaning Blade • (1) Charge Plate Assembly • (2) Drum Picker Finger • (2) Waste Toner Bottle • (4) Upper Picker Finger • (2) Lower Picker Finger • (1) Corona Screen Grid 	AR 281
NBRGY0093FCZZ	45576205 	Bearing Various Applications	AR 281
NBRGY0131FCZZ	45576204 	Bearing Various Applications	AR 281
NBRGY0466FCZZ	45576233 	Bearing Various Applications	AR 281
NBRGY0599FCZZ	45576217 	Bearing	AR 281

For use in
Sharp
Copiers

Central/Eastern Europe
Telephone: 31(0)183-696969
Fax: 31(0)183-629055
E-mail: order@edc.katun.com

OEM PN	KATUN PN	DESCRIPTION	MODEL NO.
Parts for use in Sharp AR 281			
AR-330CB	45020066 	Cleaning Blade Kit	AR 281
			<i>Priced per Kit, 10 Blades per Kit.</i>
AR-330TU	45018554 	Corona Screen Grid	AR 281
LPLTM5393FCZZ	45018554 	Corona Screen Grid	AR 281
MSPRT0513FCZZ	45524654 	Corona Wire Spring Stainless Steel Various Applications	AR 281
			<i>Priced per Spring, sold in Bags of 10.</i>
PSHEP4617FCZZ	45018032 	Developer Unit Seal	AR 281
AR-330BL	45018036 	Drum Cleaning Blade	AR 281
UCLEZ0149FCZ1	45018036 	Drum Cleaning Blade	AR 281
CDAIU0451FC51	45020110 	Drum Picker Finger Assembly	AR 281
			<i>Priced per Picker Finger, sold in Packages of 2.</i>
N/P/N	45019752 	Feed Roller Replacement Kit New Style Kit Contains: • (1) Paper Feed Roller • (1) Paper Pickup Roller • (1) Reverse Roller	AR 281
LBSHZ0330FCZZ	45012446 	Heat Insulating Sleeve	AR 281
			<i>Priced per Heat Sleeve, sold in Bags of 10.</i>
SF-240DU	45012446 	Heat Insulating Sleeve	AR 281
			<i>Priced per Heat Sleeve, sold in Bags of 10.</i>
PTME-0174FCZ1	45018041 	Lower Picker Finger	AR 281
			<i>Priced per Picker Finger, sold in Boxes of 10.</i>
AR-330HR	45018283 	Lower Pressure Roller MICROSLEEVE™	AR 281
NROLI1206FCZZ	45018283 	Lower Pressure Roller MICROSLEEVE™	AR 281
AR-330LH	45017526 	Lower Pressure Roller Kit Kit Contains: • (1) Lower Pressure Roller MICROSLEEVE™ • (2) Lower Picker Finger	AR 281















OEM PN	KATUN PN	DESCRIPTION	MODEL NO.	
Parts for use in Sharp AR 281				
NROLR1241FCZZ	45021483 	Manual Paper Feed Roller Tire Only	AR 281	<i>Priced per Tire, sold in Bags of 10.</i>
NROLR1240FCZZ	45021458 	Manual Pickup Roller Tire Only	AR 281	<i>Priced per Tire, sold in Bags of 10.</i>
NROLR1220FCZZ	45021479 	Manual Reverse Roller Tire Only	AR 281	<i>Priced per Tire, sold in Bags of 10.</i>
AR-330JL	45018864 	Ozone Filter	AR 281	
PFILZ0265FCZ1	45018864 	Ozone Filter	AR 281	
NROLR1218FCZZ	45018450 	Paper Feed Roller	AR 281	
NROLR1219FCZZ	45018451 	Paper Pickup Roller	AR 281	
NROLR1219FCZZ	45021458 	Paper Pickup Roller Tire Only	AR 281	<i>Priced per Tire, sold in Bags of 10.</i>
NROLR1229FCZZ	45018452 	Reverse Roller	AR 281	
RDTCT0134FCZZ	45017285 	Thermistor Main	AR 281	
RDTCT0135FCZZ	45017286 	Thermistor Sub	AR 281	
UCLEZ0158FCZZ	45019959 	Toner Reception Seal	AR 281	
AR-330HU	45016803 	Upper Fuser Roller OEM Type	AR 281	
NGERH1214FCZZ	45012819 	Upper Fuser Roller Gear	AR 281	
AR-330UH	45016918 	Upper Fuser Roller Kit Kit Contains: <ul style="list-style-type: none"> • (1) Upper Fuser Roller REVOLUTION™ • (1) Upper Fuser Roller Gear • (4) Upper Picker Finger 	AR 281	
PTME-0168FCZZ	45013096 	Upper Picker Finger	AR 281	<i>Priced per Picker Finger, sold in Packages of 10.</i>
PRNGP0015FCZZ	45012311 	V Ring	AR 281	<i>Priced per Bag, 4 Seals per Bag.</i>



For use in
Sharp
Copiers

Central/Eastern Europe
Telephone: 31(0)183-696969
Fax: 31(0)183-629055
E-mail: order@edc.katun.com

OEM PN	KATUN PN	DESCRIPTION	MODEL NO.
Parts for use in Sharp AR 281			
AR-330TB	45017921 	Waste Toner Bottle	AR 281
CYOK-0053FC01	45017921 	Waste Toner Bottle	AR 281
Parts for use in Sharp AR 287, AR 337			
AR-330KB	45022595 	160K PM Kit Kit Contains: • (1) Upper Fuser Roller Gear • (1) Upper Fuser Roller • (1) Developer Unit Seal • (1) Lower Pressure Roller • (1) Toner Reception Seal	AR 337
AR-330KA	45018881 	80K PM Kit Kit Contains: • (1) Drum Cleaning Blade • (1) Charge Plate Assembly • (2) Drum Picker Finger • (2) Waste Toner Bottle • (4) Upper Picker Finger • (2) Lower Picker Finger • (1) Corona Screen Grid	AR 287, AR 337
AR-400KA	45018881 	90k PM KIT Kit Contains: • (1) Drum Cleaning Blade • (1) Charge Plate Assembly • (2) Drum Picker Finger • (2) Waste Toner Bottle • (4) Upper Picker Finger • (2) Lower Picker Finger • (1) Corona Screen Grid	AR 287, AR 337
NBRGY0093FCZZ	45576205 	Bearing Various Applications	AR 287, AR 337
NBRGY0131FCZZ	45576204 	Bearing Various Applications	AR 287, AR 337
NBRGY0466FCZZ	45576233 	Bearing Various Applications	AR 287, AR 337
NBRGY0599FCZZ	45576217 	Bearing	AR 287, AR 337
AR-330CB	45020066 	Cleaning Blade Kit	AR 287, AR 337
AR-330TU	45018554 	Corona Screen Grid	AR 287, AR 337
LPLTM5393FCZZ	45018554 	Corona Screen Grid	AR 287, AR 337

*Priced per Kit,
10 Blades per Kit.*

OEM PN	KATUN PN	DESCRIPTION	MODEL NO.
Parts for use in Sharp AR 287, AR 337			
MSPRT0513FCZZ	45524654 	Corona Wire Spring Stainless Steel Various Applications	AR 287, AR 337 <i>Priced per Spring, sold in Bags of 10.</i>
PSHEP4617FCZZ	45018032 	Developer Unit Seal	AR 287, AR 337
AR-330BL	45018036 	Drum Cleaning Blade	AR 287, AR 337
UCLEZ0149FCZ1	45018036 	Drum Cleaning Blade	AR 287, AR 337
N/P/N	45019752 	Feed Roller Replacement Kit New Style Kit Contains: • (1) Paper Feed Roller • (1) Paper Pickup Roller • (1) Reverse Roller	AR 287, AR 337
LBSHZ0330FCZZ	45012446 	Heat Insulating Sleeve	AR 287, AR 337 <i>Priced per Heat Sleeve, sold in Bags of 10.</i>
SF-240DU	45012446 	Heat Insulating Sleeve	AR 287, AR 337 <i>Priced per Heat Sleeve, sold in Bags of 10.</i>
PTME-0174FCZ1	45018041 	Lower Picker Finger	AR 287, AR 337 <i>Priced per Picker Finger, sold in Boxes of 10.</i>
AR-505HR	45018579 	Lower Pressure Roller MICROSLEEVE™	AR 287, AR 337
NROLI1286FCZZ	45018579 	Lower Pressure Roller MICROSLEEVE™	AR 287, AR 337
NROLR1241FCZZ	45021483 	Manual Paper Feed Roller Tire Only	AR 287, AR 337 <i>Priced per Tire, sold in Bags of 10.</i>
NROLR1240FCZZ	45021458 	Manual Pickup Roller Tire Only	AR 287, AR 337 <i>Priced per Tire, sold in Bags of 10.</i>
NROLR1220FCZZ	45021479 	Manual Reverse Roller Tire Only	AR 287, AR 337 <i>Priced per Tire, sold in Bags of 10.</i>
AR-330JL	45018864 	Ozone Filter	AR 287, AR 337
PFILZ0265FCZ1	45018864 	Ozone Filter	AR 287, AR 337
NROLR1218FCZZ	45018450 	Paper Feed Roller	AR 287, AR 337



For use in
Sharp
Copiers

Central/Eastern Europe
Telephone: 31(0)183-696969
Fax: 31(0)183-629055
E-mail: order@edc.katun.com

OEM PN	KATUN PN	DESCRIPTION	MODEL NO.
Parts for use in Sharp AR 287, AR 337			
NROLR1219FCZZ	45018451	Paper Pickup Roller	AR 287, AR 337
NROLR1219FCZZ	45021458	Paper Pickup Roller Tire Only	AR 287, AR 337
NROLR1229FCZZ	45018452	Reverse Roller	AR 287, AR 337
RDTCT0134FCZZ	45017285	Thermistor Main	AR 287, AR 337
RDTCT0135FCZZ	45017286	Thermistor Sub	AR 287, AR 337
UCLEZ0158FCZZ	45019959	Toner Reception Seal	AR 287, AR 337
AR-330HU	45016803	Upper Fuser Roller OEM Type	AR 287, AR 337
NGERH1214FCZZ	45012819	Upper Fuser Roller Gear	AR 287, AR 337
AR-330UH	45016918	Upper Fuser Roller Kit Kit Contains: • (1) Upper Fuser Roller REVOLUTION™ • (1) Upper Fuser Roller Gear • (4) Upper Picker Finger	AR 287, AR 337
PTME-0168FCZZ	45013096	Upper Picker Finger	AR 287, AR 337
PRNGP0015FCZZ	45012311	V Ring	AR 287, AR 337
AR-330TB	45017921	Waste Toner Bottle	AR 287, AR 337
CYOK-0053FC01	45017921	Waste Toner Bottle	AR 287, AR 337

*Priced per Tire,
sold in Bags of 10.*

*Priced per Picker Finger,
sold in Packages of 10.*

*Priced per Bag,
4 Seals per Bag.*













Parts for use in Sharp AR 405, AR 407

AR-330KB	45022595	160K PM Kit Kit Contains: • (1) Upper Fuser Roller Gear • (1) Upper Fuser Roller • (1) Developer Unit Seal • (1) Lower Pressure Roller • (1) Toner Reception Seal	AR 405, AR 407
----------	----------	--	----------------



Katun Performance Product

© 2004 Katun Corporation

OEM PN	KATUN PN	DESCRIPTION	MODEL NO.
Parts for use in Sharp AR 405, AR 407			
AR-400KB	45022596 	180K PM Kit Kit Contains: <ul style="list-style-type: none"> • (1) Upper Fuser Roller Gear • (1) Upper Fuser Roller • (1) Developer Unit Seal • (1) Lower Pressure Roller • (1) Toner Reception Seal 	AR 405
AR-400KA	45018881 	90k PM KIT Kit Contains: <ul style="list-style-type: none"> • (1) Drum Cleaning Blade • (1) Charge Plate Assembly • (2) Drum Picker Finger • (2) Waste Toner Bottle • (4) Upper Picker Finger • (2) Lower Picker Finger • (1) Corona Screen Grid 	AR 405, AR 407
OCW2160P344//	45576233 	Bearing	AR 405, AR 407
NBRGY0093FCZZ	45576205 	Bearing Various Applications	AR 405, AR 407
NBRGY0131FCZZ	45576204 	Bearing Various Applications	AR 405, AR 407
NBRGY0466FCZZ	45576233 	Bearing Various Applications	AR 405, AR 407
NBRGY0599FCZZ	45576217 	Bearing	AR 405, AR 407
AR-330CB	45020066 	Cleaning Blade Kit	AR 405, AR 407
AR-330TU	45018554 	Corona Screen Grid	AR 405, AR 407
LPLTM5393FCZZ	45018554 	Corona Screen Grid	AR 405, AR 407
DWIR-0466CSZZ	45375548 	Corona Wire Spool 50 m / Spool 70μ Oxidized Charge	AR 405
DWIR-0550CSZZ	45375120 	Corona Wire Spool 50 m / Spool 60μ 0.3μ Gold Plated Transfer, Separation	AR 405
MSPRT0513FCZZ	45524654 	Corona Wire Spring Stainless Steel Various Applications	AR 405, AR 407

*Priced per Kit,
 10 Blades per Kit.*

*Priced per Spring,
 sold in Bags of 10.*

For use in
Sharp
Copiers

Central/Eastern Europe
Telephone: 31(0)183-696969
Fax: 31(0)183-629055
E-mail: order@edc.katun.com

OEM PN	KATUN PN	DESCRIPTION	MODEL NO.
Parts for use in Sharp AR 405, AR 407			
NROLR1285FCZZ	45021824	Curl Adjustment Roller	AR 405
PSHEP4617FCZZ	45018032	Developer Unit Seal	AR 405, AR 407
AR-330BL	45018036	Drum Cleaning Blade	AR 405, AR 407
UCLEZ0149FCZ1	45018036	Drum Cleaning Blade	AR 405, AR 407
CDAIU0451FC52	45020110	Drum Picker Finger Assembly	AR 405
N/P/N	45019752	Feed Roller Replacement Kit New Style Kit Contains: • (1) Paper Feed Roller • (1) Paper Pickup Roller • (1) Reverse Roller	AR 405, AR 407
LBSHZ0330FCZZ	45012446	Heat Insulating Sleeve	AR 405, AR 407
SF-240DU	45012446	Heat Insulating Sleeve	AR 405, AR 407
PTME-0174FCZ1	45018041	Lower Picker Finger	AR 405, AR 407
AR-330HR	45018283	Lower Pressure Roller MICROSLEEVE™	AR 405
NROLI1206FCZZ	45018283	Lower Pressure Roller MICROSLEEVE™	AR 405
AR-505HR	45018579	Lower Pressure Roller MICROSLEEVE™	AR 407
NROLI1286FCZZ	45018579	Lower Pressure Roller MICROSLEEVE™	AR 407
AR-330LH	45017526	Lower Pressure Roller Kit Kit Contains: • (1) Lower Pressure Roller MICROSLEEVE™ • (2) Lower Picker Finger	AR 405
NROLR1241FCZZ	45021483	Manual Paper Feed Roller Tire Only	AR 405, AR 407

*Priced per Picker Finger,
sold in Packages of 2.*

*Priced per Heat Sleeve,
sold in Bags of 10.*

*Priced per Heat Sleeve,
sold in Bags of 10.*















*Priced per Picker Finger,
sold in Boxes of 10.*

*Priced per Tire,
sold in Bags of 10.*















Katun Performance Product

© 2004 Katun Corporation

OEM PN	KATUN PN	DESCRIPTION	MODEL NO.
Parts for use in Sharp AR 405, AR 407			
NROLR1240FCZZ	45021458 	Manual Pickup Roller Tire Only	AR 405, AR 407
			<i>Priced per Tire, sold in Bags of 10.</i>
NROLR1220FCZZ	45021479 	Manual Reverse Roller Tire Only	AR 405, AR 407
			<i>Priced per Tire, sold in Bags of 10.</i>
0CW2214P575//	45019289 	Original Document Feed Belt	AR 405, AR 407
0CW2214P339//	45014070 	Original Feed Roller Tire Only	AR 405, AR 407
			<i>Priced per Tire, sold in Bags of 4.</i>
0CW2214P471//	45019943 	Original Pickup Roller Ribbed Tire For Document Feeder	AR 405, AR 407
			<i>Priced per Pickup Roller, sold in Bags of 10.</i>
0CW2231K064//	45019944 	Original Separation Roller	AR 405, AR 407
AR-330JL	45018864 	Ozone Filter	AR 405, AR 407
PFILZ0265FCZ1	45018864 	Ozone Filter	AR 405, AR 407
NROLR1218FCZZ	45018450 	Paper Feed Roller	AR 405, AR 407
NROLR1219FCZZ	45018451 	Paper Pickup Roller	AR 405, AR 407
NROLR1219FCZZ	45021458 	Paper Pickup Roller Tire Only	AR 405, AR 407
			<i>Priced per Tire, sold in Bags of 10.</i>
NROLR1229FCZZ	45018452 	Reverse Roller	AR 405, AR 407
RDTCT0134FCZZ	45017285 	Thermistor Main	AR 405, AR 407
RDTCT0135FCZZ	45017286 	Thermistor Sub	AR 405, AR 407
UCLEZ0158FCZZ	45019959 	Toner Reception Seal	AR 405, AR 407
AR-400HU	45016803 	Upper Fuser Roller OEM Type	AR 405, AR 407
NROLT1277FCZZ	45016803 	Upper Fuser Roller OEM Type	AR 405, AR 407
NGERH1214FCZZ	45012819 	Upper Fuser Roller Gear	AR 405, AR 407

For use in
Sharp
Copiers















Central/Eastern Europe
Telephone: 31(0)183-696969
Fax: 31(0)183-629055
E-mail: order@edc.katun.com

OEM PN	KATUN PN	DESCRIPTION	MODEL NO.
Parts for use in Sharp AR 405, AR 407			
AR-330UH	45016918 	Upper Fuser Roller Kit Kit Contains: • (1) Upper Fuser Roller REVOLUTION™ • (1) Upper Fuser Roller Gear • (4) Upper Picker Finger	AR 405, AR 407
PTME-0168FCZZ	45013096 	Upper Picker Finger	AR 405, AR 407
PRNGP0015FCZZ	45012311 	V Ring	AR 405, AR 407
AR-330TB	45017921 	Waste Toner Bottle	AR 405, AR 407
CYOK-0053FC01	45017921 	Waste Toner Bottle	AR 405, AR 407
Parts for use in Sharp AR 501, AR 505, AR 507			
AR-505KA	45022594 	125K Maintenance Kit Kit Contains: • (1) Charge Plate Assembly • (3) Waste Toner Bottle • (1) Drum Cleaning Blade • (2) Picker Finger • (1) Corona Screen Grid • (4) Upper Picker Finger • (2) Drum Picker Finger • (1) Thermistor Cleaning Roller	AR 505, AR 507
OCW2160P344//	45576233 	Bearing	AR 505, AR 507
NBRGY0131FCZZ	45576204 	Bearing Various Applications	AR 505, AR 507
NBRGY0466FCZZ	45576233 	Bearing Various Applications	AR 505, AR 507
NBRGY0599FCZZ	45576217 	Bearing	AR 505, AR 507
AR-330CB	45020066 	Cleaning Blade Kit	AR 501, AR 505, AR 507
AR-330TU	45018554 	Corona Screen Grid	AR 501, AR 505, AR 507
LPLTM5393FCZZ	45018554 	Corona Screen Grid	AR 505, AR 507

*Priced per Picker Finger,
sold in Packages of 10.*

*Priced per Bag,
4 Seals per Bag.*



















*Priced per Kit,
10 Blades per Kit.*

OEM PN	KATUN PN	DESCRIPTION	MODEL NO.
Parts for use in Sharp AR 501, AR 505, AR 507			
DWIR-0466CSZZ	45375548 	Corona Wire Spool 50 m / Spool 70µ Oxidized Charge	AR 505
MSPRT0513FCZZ	45524654 	Corona Wire Spring Stainless Steel Various Applications	AR 505, AR 507
			<i>Priced per Spring, sold in Bags of 10.</i>
NROLR1285FCZZ	45021824 	Curl Adjustment Roller	AR 501, AR 505, AR 507
PSHEP4617FCZZ	45018032 	Developer Unit Seal	AR 505, AR 507
AR-330BL	45018036 	Drum Cleaning Blade	AR 501, AR 505, AR 507
UCLEZ0149FCZ1	45018036 	Drum Cleaning Blade	AR 501, AR 505, AR 507
N/P/N	45019752 	Feed Roller Replacement Kit New Style Kit Contains: • (1) Paper Feed Roller • (1) Paper Pickup Roller • (1) Reverse Roller	AR 505, AR 507
LBSHZ0330FCZZ	45012446 	Heat Insulating Sleeve	AR 505, AR 507
			<i>Priced per Heat Sleeve, sold in Bags of 10.</i>
SF-240DU	45012446 	Heat Insulating Sleeve	AR 501, AR 505, AR 507
			<i>Priced per Heat Sleeve, sold in Bags of 10.</i>
PTME-0174FCZ1	45018041 	Lower Picker Finger	AR 505, AR 507
			<i>Priced per Picker Finger, sold in Boxes of 10.</i>
AR-505HR	45018579 	Lower Pressure Roller MICROSLEEVE™	AR 501, AR 505, AR 507
NROLI1286FCZZ	45018579 	Lower Pressure Roller MICROSLEEVE™	AR 505, AR 507
NROLR1241FCZZ	45021483 	Manual Paper Feed Roller Tire Only	AR 505, AR 507
			<i>Priced per Tire, sold in Bags of 10.</i>
NROLR1240FCZZ	45021458 	Manual Pickup Roller Tire Only	AR 505, AR 507
			<i>Priced per Tire, sold in Bags of 10.</i>
NROLR1220FCZZ	45021479 	Manual Reverse Roller Tire Only	AR 505, AR 507
			<i>Priced per Tire, sold in Bags of 10.</i>



For use in
Sharp
Copiers



Central/Eastern Europe
Telephone: 31(0)183-696969
Fax: 31(0)183-629055
E-mail: order@edc.katun.com

OEM PN	KATUN PN	DESCRIPTION	MODEL NO.
Parts for use in Sharp AR 501, AR 505, AR 507			
AR-330JL	45018864 	Ozone Filter	AR 501, AR 505, AR 507
PFILZ0265FCZ1	45018864 	Ozone Filter	AR 505, AR 507
NROLR1218FCZZ	45018450 	Paper Feed Roller	AR 505, AR 507
NROLR1219FCZZ	45018451 	Paper Pickup Roller	AR 505, AR 507
NROLR1219FCZZ	45021458 	Paper Pickup Roller Tire Only	AR 505, AR 507
			<i>Priced per Tire, sold in Bags of 10.</i>
OCW2254P302//	45021896 	Pickup Roller Tire Only Ribbed Tire	AR 505, AR 507
			<i>Priced per Tire, sold in Bags of 10.</i>
NROLR1229FCZZ	45018452 	Reverse Roller	AR 505, AR 507
OCW2254K073B/	45022962 	Separation Pad	AR 505, AR 507
OCW2254P301//	45021614 	Separation Roller Tire Only	AR 505, AR 507
			<i>Priced per Tire, sold in Bags of 10.</i>
NBRGC0136FCZZ	45016755 	Sintered Bronze Bushing	AR 505, AR 507
			<i>Priced per Bushing, sold in Packages of 10.</i>
RDTCT0134FCZZ	45017285 	Thermistor Main	AR 505, AR 507
NROLN0874FCZZ	45021425 	Thermistor Cleaning Roller	AR 505, AR 507
UCLEZ0158FCZZ	45019959 	Toner Reception Seal	AR 501, AR 505, AR 507
AR-505HU	45018843 	Upper Fuser Roller	AR 501, AR 505, AR 507
NROLT1283FCZZ	45018843 	Upper Fuser Roller	AR 505, AR 507
PTME-0168FCZZ	45013096 	Upper Picker Finger	AR 501, AR 505, AR 507
			<i>Priced per Picker Finger, sold in Packages of 10.</i>
PTME-0278FCZZ	45018645 	Upper Picker Finger	AR 501, AR 505, AR 507
			<i>Priced per Picker Finger, sold in Bags of 4.</i>
PRNGP0096FCZZ	45012311 	V Ring	AR 505, AR 507
			<i>Priced per Bag, 4 Seals per Bag.</i>















OEM PN	KATUN PN	DESCRIPTION	MODEL NO.
--------	----------	-------------	-----------

Parts for use in Sharp AR 501, AR 505, AR 507

AR-330TB	45017921 	Waste Toner Bottle	AR 501, AR 505, AR 507
CYOK-0053FC01	45017921 	Waste Toner Bottle	AR 505, AR 507



Parts for use in Sharp AR 651

0N4407545610/	45576204 	Bearing Various Applications	AR 651
0N4408510800/	45576233 	Bearing	AR 651
0N6LA27031000	45023549 	Cleaning Web	AR 651
0N4409894220/	45019788 	Drum Cleaning Blade Kit Contains: • (1) Drum Cleaning Blade	AR 651
0N4401762580/	45019951 	Drum Picker Finger	AR 651
0N4401902550/	45576260 	Heat Insulating Sleeve	AR 651
4409 893740	45018379 	Lower Fuser Cleaning Roller	AR 651
B 8070 L	45018379 	Lower Fuser Cleaning Roller	AR 651
0N4409894280/	45018043 	Lower Oil Supply Roller	AR 651
0N6LA27060000	45023611 	Lower Pressure Roller MICROSLEEVE™	AR 651
0N4409894260/	45018042 	Oil Supply Roller	AR 651
0N6LA27028000	45023749 	Upper Fuser Roller DURACON™ II	AR 651

*Priced per Picker Finger,
 sold in Bags of 2.*

*Priced per Heat Sleeve,
 sold in Bags of 10.*

Parts for use in Sharp AR 810













0N4407545610/	45576204 	Bearing Various Applications	AR 810
0N4408510800/	45576233 	Bearing	AR 810
0N6LA27031000	45023549 	Cleaning Web	AR 810

For use in
Sharp
Copiers

Central/Eastern Europe
Telephone: 31(0)183-696969
Fax: 31(0)183-629055
E-mail: order@edc.katun.com

OEM PN	KATUN PN	DESCRIPTION	MODEL NO.
Parts for use in Sharp AR 810			
0N4409894220/	45019788 	Drum Cleaning Blade Kit Contains: • (1) Drum Cleaning Blade	AR 810
0N4401762580/	45019951 	Drum Picker Finger	AR 810
			<i>Priced per Picker Finger, sold in Bags of 2.</i>
0N4401902550/	45576260 	Heat Insulating Sleeve	AR 810
			<i>Priced per Heat Sleeve, sold in Bags of 10.</i>
4409 893740	45018379 	Lower Fuser Cleaning Roller	AR 810
B 8070 L	45018379 	Lower Fuser Cleaning Roller	AR 810
0N4409894280/	45018043 	Lower Oil Supply Roller	AR 810
0N6LA27060000	45023611 	Lower Pressure Roller MICROSLEEVE™	AR 810
0N4409894260/	45018042 	Oil Supply Roller	AR 810
0N6LA27028000	45023749 	Upper Fuser Roller DURACON™ II	AR 810
Parts for use in Sharp AR 5015			
DWIR-0466CSZZ	45375548 	Corona Wire Spool 50 m / Spool 70μ Oxidized Transfer, Separation	AR 5015
UCLEZ0009QSZ1	45017810 	Drum Cleaning Blade	AR 5015
NROLR0031QSZ1	45019860 	Lower Pressure Roller MICROSLEEVE™	AR 5015
NROLR0922FCZZ	45016478 	Manual Paper Feed Roller	AR 5015
CROLP1115FC01	45014266 	Manual Pickup Roller Tire Only	AR 5015
			<i>Priced per Tire, sold in Bags of 10.</i>
PGUMM0012QSZZ	45022795 	Paper Feed Tire Green Tire For PN:CSFTZ0066RS71	AR 5015
			<i>Priced per Tire, sold in Bags of 10.</i>
NROLI0030QSZZ	45018350 	Upper Fuser Roller	AR 5015



OEM PN	KATUN PN	DESCRIPTION	MODEL NO.
Parts for use in Sharp AR 5015			
NBRGP0567FCZZ	45020088 	Upper Fuser Roller Bushing	AR 5015
			<i>Priced per Bushing, sold in Bags of 10.</i>
Parts for use in Sharp AR 5040			
N/P/N	45018868 	80K Maintenance Kit Kit Contains: <ul style="list-style-type: none"> • (1) Drum Cleaning Blade • (1) Lower Fuser Cleaning Roller • (2) Drum Picker Finger • (4) Upper Picker Finger • (1) Corona Screen Grid • (1) Upper Fuser Cleaning Roller • (4) Waste Toner Bottle • (2) Lower Picker Finger 	AR 5040
OCW2160P344A/	45576233 	Bearing Various Applications	AR 5040
NBRGY0131FCZZ	45576204 	Bearing Various Applications	AR 5040
NBRGY0466FCZZ	45576233 	Bearing Various Applications	AR 5040
DWIR-0466CSZZ	45375548 	Corona Wire Spool 50 m / Spool 70µ Oxidized Transfer, Separation	AR 5040
MSPRT0513FCZZ	45524654 	Corona Wire Spring Stainless Steel Various Applications	AR 5040
			<i>Priced per Spring, sold in Bags of 10.</i>
UCLEZ0078FCZ4	45243495 	Drum Cleaning Blade	AR 5040
UCLEZ0078FCZ4	45022583	Drum Cleaning Blade Access By Katun	AR 5040
LBSHC0228FCZZ	45012446 	Heat Insulating Sleeve	AR 5040
			<i>Priced per Heat Sleeve, sold in Bags of 10.</i>
NROLN0587FCZZ	45021510 	Lower Fuser Cleaning Roller	AR 5040
NBRGY0296FCZZ	45013093 	Lower Fuser Roller Bearing	AR 5040
PTME-0174FCZ1	45018041 	Lower Picker Finger	AR 5040
			<i>Priced per Picker Finger, sold in Boxes of 10.</i>
NROLR0922FCZZ	45016478 	Manual Paper Feed Roller	AR 5040



For use in
Sharp
Copiers

Central/Eastern Europe
Telephone: 31(0)183-696969
Fax: 31(0)183-629055
E-mail: order@edc.katun.com

OEM PN	KATUN PN	DESCRIPTION	MODEL NO.	
Parts for use in Sharp AR 5040				
CGUMM0286FC31	45009690 	Manual Paper Feed Tire Tire Only	AR 5040	<i>Priced per Tire, sold in Bags of 10.</i>
CROLP0921FC01	45017033 	Manual Pickup Roller	AR 5040	
CROLP0921FC01	45011442 	Manual Pickup Roller Tire Only Ribbed Tire	AR 5040	<i>Priced per Tire, sold in Bags of 10.</i>
CSFTZ1771FC31	45011357 	Manual Reverse Roller Assembly Tire Only	AR 5040	<i>Priced per Tire, sold in Bags of 10.</i>
OCW2168P355A/	45020057 	Original Document Feed Belt	AR 5040	
OCW2158P366A/	45011370 	Original Feed Roller Tire Only	AR 5040	<i>Priced per Tire, sold in Bags of 5.</i>
OCW2158P364A/	45019943 	Original Pickup Roller Ribbed Tire For Document Feeder	AR 5040	<i>Priced per Pickup Roller, sold in Bags of 10.</i>
NROLR0901FCZZ	45016481 	Paper Feed Roller	AR 5040	
NROLR0901FCZZ	45011352 	Paper Feed Roller Tire Only	AR 5040	<i>Priced per Tire, sold in Bags of 10.</i>
NROLR0920FCZZ	45016480 	Paper Pickup Roller	AR 5040	
NROLR0920FCZZ	45011442 	Paper Pickup Roller Tire Only Ribbed Tire	AR 5040	<i>Priced per Tire, sold in Bags of 10.</i>
OCW2158P317A/	45013785 	Reverse Roller Tire Only	AR 5040	<i>Priced per Tire, sold in Bags of 10.</i>
OCW2158P492A/	45014427 	Separation Belt Gray	AR 5040	
NROLR0902FCZZ	45016479 	Separation Roller	AR 5040	
NROLR0902FCZZ	45011352 	Separation Roller Tire Only	AR 5040	<i>Priced per Tire, sold in Bags of 10.</i>
NBRGC0136FCZZ	45016755 	Sintered Bronze Bushing	AR 5040	<i>Priced per Bushing, sold in Packages of 10.</i>











Katun Performance Product





© 2004 Katun Corporation

26 October 2004

For the most current product and pricing information, visit the Katun On-Line Catalog at www.katun.com.







Prices, terms and conditions are subject to change without notice.

OEM PN	KATUN PN	DESCRIPTION	MODEL NO.	
Parts for use in Sharp AR 5040				
NBRGC0140FCZZ	45016756 	Sintered Bronze Bushing	AR 5040	<i>Priced per Bushing, sold in Packages of 10.</i>
CROLN0586FC34	45016812 	Upper Fuser Cleaning Roller	AR 5040	
NROLT0613FCZZ	45013170 	Upper Fuser Roller ALUMANA™ Patented TEFLON® coating with reinforcing oxides extends life.	AR 5040	
NBRGY0295FCZZ	45576217 	Upper Fuser Roller Bearing	AR 5040	
NGERH0475FCZ1	45012825 	Upper Fuser Roller Gear	AR 5040	
PTME-0149FCZZ	45013096 	Upper Picker Finger	AR 5040	<i>Priced per Picker Finger, sold in Packages of 10.</i>
PRNGP0013FCZZ	45011640 	V Ring	AR 5040	<i>Priced per Seal, sold in Bags of 4.</i>
PRNGP0015FCZZ	45012311 	V Ring	AR 5040	<i>Priced per Bag, 4 Seals per Bag.</i>
PRNGP0069FCZZ	45018026 	V Ring	AR 5040	<i>Priced per Seal, sold in Bags of 4.</i>

Parts for use in Sharp AR 5125, AR 5132				
N/P/N	45018868 	80K Maintenance Kit Kit Contains: <ul style="list-style-type: none"> • (1) Drum Cleaning Blade • (1) Lower Fuser Cleaning Roller • (2) Drum Picker Finger • (4) Upper Picker Finger • (1) Corona Screen Grid • (1) Upper Fuser Cleaning Roller • (4) Waste Toner Bottle • (2) Lower Picker Finger 	AR 5132	
OCW2160P344A/	45576233 	Bearing Various Applications	AR 5125, AR 5132	
NBRGY0466FCZZ	45576233 	Bearing Various Applications	AR 5125, AR 5132	
LPLTZ4952FCZZ	45016709 	Corona Screen Grid	AR 5125, AR 5132	

For use in
Sharp
Copiers

Central/Eastern Europe
Telephone: 31(0)183-696969
Fax: 31(0)183-629055
E-mail: order@edc.katun.com

OEM PN	KATUN PN	DESCRIPTION	MODEL NO.
Parts for use in Sharp AR 5125, AR 5132			
DWIR-0466CSZZ	45375548 	Corona Wire Spool 50 m / Spool 70µ Oxidized Transfer, Separation	AR 5125, AR 5132
MSPRT0513FCZZ	45524654 	Corona Wire Spring Stainless Steel Various Applications	AR 5125, AR 5132 <i>Priced per Spring, sold in Bags of 10.</i>
UCLEZ0136FCZZ	45014743 	Developer Unit Seal	AR 5125, AR 5132
CCLEZ0117FC31	45010155 	Drum Cleaning Blade	AR 5125, AR 5132
CCLEZ0117FC31	45022581	Drum Cleaning Blade Access By Katun	AR 5125, AR 5132
SF-222BL	45010155 	Drum Cleaning Blade	AR 5125, AR 5132
CDAIU0451FC51	45020110 	Drum Picker Finger Assembly	AR 5125, AR 5132 <i>Priced per Picker Finger, sold in Packages of 2.</i>
NROLR0904FCZZ	45023073 	Duplex Paper Pickup Roller	AR 5125, AR 5132
N/P/N	45014639 	Feed Tire Replacement Kit Tire Only Old Style Kit Contains: • (1) Paper Pickup Tire • (1) Paper Feed Tire • (1) Separation Tire	AR 5125, AR 5132
LBSHZ0330FCZZ	45012446 	Heat Insulating Sleeve	AR 5125, AR 5132 <i>Priced per Heat Sleeve, sold in Bags of 10.</i>
SF-240DU	45012446 	Heat Insulating Sleeve	AR 5125, AR 5132 <i>Priced per Heat Sleeve, sold in Bags of 10.</i>
CROLN0912FC31	45021394 	Lower Fuser Cleaning Roller	AR 5125, AR 5132
NBRGY0296FCZZ	45013093 	Lower Fuser Roller Bearing	AR 5125, AR 5132
PTME-0174FCZ1	45018041 	Lower Picker Finger	AR 5125, AR 5132 <i>Priced per Picker Finger, sold in Boxes of 10.</i>
NROLI1103FCZZ	45013214 	Lower Pressure Roller MICROSLEEVE™	AR 5125, AR 5132













Katun Performance Product

© 2004 Katun Corporation

OEM PN	KATUN PN	DESCRIPTION	MODEL NO.
Parts for use in Sharp AR 5125, AR 5132			
SF-240HR	45013214 	Lower Pressure Roller MICROSLEEVE™	AR 5125, AR 5132
NROLR1051FCZZ	45012886 	Manual Paper Feed Roller Tire Only	AR 5125, AR 5132
			<i>Priced per Tire, sold in Bags of 10.</i>
CGUMM0288FC31	45014266 	Manual Paper Pickup Tire Tire Only	AR 5125, AR 5132
			<i>Priced per Tire, sold in Bags of 10.</i>
CROLP1115FC01	45014266 	Manual Pickup Roller Tire Only	AR 5125, AR 5132
			<i>Priced per Tire, sold in Bags of 10.</i>
CSFTZ2233FC31	45013175 	Manual Reverse Roller Assembly Tire Only	AR 5125, AR 5132
			<i>Priced per Tire, sold in Bags of 10.</i>
0CW2214P353//	45019289 	Original Document Feed Belt	AR 5125, AR 5132
0CW2214P339//	45014070 	Original Feed Roller Tire Only	AR 5125, AR 5132
			<i>Priced per Tire, sold in Bags of 4.</i>
0CW2214P471//	45019943 	Original Pickup Roller Ribbed Tire For Document Feeder	AR 5125, AR 5132
			<i>Priced per Pickup Roller, sold in Bags of 10.</i>
0CW2231K064//	45019944 	Original Separation Roller	AR 5125, AR 5132
0CW4051P397//	45016761 	Paper Feed Roller Tire Only	AR 5125, AR 5132
			<i>Priced per Tire, sold in Bags of 6.</i>
NROLR0986FCZZ	45020763 	Paper Feed Roller Tire Only For duplex unit only	AR 5125, AR 5132
			<i>Priced per Tire, sold in Bags of 10.</i>
NROLR0986FCZZ	45011352 	Paper Feed Roller Tire Only	AR 5125, AR 5132
			<i>Priced per Tire, sold in Bags of 10.</i>
NROLR1049FCZZ	45016482 	Paper Feed Roller	AR 5125, AR 5132
NROLR1049FCZZ	45012632 	Paper Feed Roller Tire Only	AR 5125, AR 5132
			<i>Priced per Tire, sold in Bags of 10.</i>
NROLR1114FCZZ	45014266 	Paper Pickup Roller Tire Only	AR 5125, AR 5132
			<i>Priced per Tire, sold in Bags of 10.</i>
NROLR1093FCZZ	45017034 	Reverse Roller	AR 5125, AR 5132

For use in
Sharp
Copiers

Central/Eastern Europe
Telephone: 31(0)183-696969
Fax: 31(0)183-629055
E-mail: order@edc.katun.com

OEM PN	KATUN PN	DESCRIPTION	MODEL NO.	
Parts for use in Sharp AR 5125, AR 5132				
NROLR1093FCZZ	45011352 	Reverse Roller Tire Only	AR 5125, AR 5132	<i>Priced per Tire, sold in Bags of 10.</i>
NROLR0909FCZZ	45016309 	Separation Roller Tire Only	AR 5125, AR 5132	<i>Priced per Tire, sold in Bags of 10.</i>
CGUMM0287FC31	45016309 	Separation Tire Tire Only	AR 5125, AR 5132	<i>Priced per Tire, sold in Bags of 10.</i>
UCLEZ0126FCZ1	45012723 	Toner Holder Seal	AR 5125, AR 5132	
CROLN0935FC31	45016768 	Upper Fuser Cleaning Roller Assembly	AR 5125, AR 5132	
AR-532HU	45014437 	Upper Fuser Roller ALUMANA™ Patented TEFLON® coating with reinforcing oxides extends life.	AR 5125, AR 5132	
NROLT1196FCZZ	45014437 	Upper Fuser Roller ALUMANA™ Patented TEFLON® coating with reinforcing oxides extends life.	AR 5125, AR 5132	
NBRGY0295FCZZ	45576217 	Upper Fuser Roller Bearing	AR 5125, AR 5132	
NGERH0475FCZ1	45012825 	Upper Fuser Roller Gear	AR 5125, AR 5132	
PTME-0168FCZZ	45013096 	Upper Picker Finger	AR 5125, AR 5132	<i>Priced per Picker Finger, sold in Packages of 10.</i>
PRNGP0050FCZZ	45012311 	V Ring	AR 5125, AR 5132	<i>Priced per Bag, 4 Seals per Bag.</i>
PRNGP0051FCZZ	45011640 	V Ring	AR 5125, AR 5132	<i>Priced per Seal, sold in Bags of 4.</i>
CYOK-0039FC01	45014388 	Waste Toner Bottle	AR 5125, AR 5132	
Parts for use in Sharp AR C 150, AR C 250				
NBRGY0599FCZZ	45576217 	Bearing	AR C 150	
NBRGY0131FCZZ	45576204 	Bearing Various Applications	AR C 150, AR C 250	
NBRGY0466FCZZ	45576233 	Bearing Various Applications	AR C 150, AR C 250	
UCLEZ0156FCZZ	45021493 	Drum Cleaning Blade	AR C 150, AR C 250	









Katun Performance Product



© 2004 Katun Corporation

OEM PN	KATUN PN	DESCRIPTION	MODEL NO.
--------	----------	-------------	-----------

Parts for use in Sharp AR C 150, AR C 250

















N/P/N	45019752 	Feed Roller Replacement Kit New Style Kit Contains: • (1) Paper Feed Roller • (1) Paper Pickup Roller • (1) Reverse Roller	AR C 150	
AR-C15SL	45021645 	Fuser Oil 800 g / Bottle	AR C 150, AR C 250	<i>Priced per Bottle, sold in Boxes of 6.</i>
NROLM1300FCZZ	45021729 	Lower Pressure Roller Silicone Based	AR C 250	
NROLR1218FCZZ	45018450 	Paper Feed Roller	AR C 150, AR C 250	
NROLR1219FCZZ	45018451 	Paper Pickup Roller	AR C 150, AR C 250	
NROLR1219FCZZ	45021458 	Paper Pickup Roller Tire Only	AR C 150, AR C 250	<i>Priced per Tire, sold in Bags of 10.</i>
NROLR1229FCZZ	45018452 	Reverse Roller	AR C 150, AR C 250	
UCLEZ0157FCZZ	45021639 	Toner Seal Blade	AR C 150, AR C 250	
NROLN1249FCZZ	45021698 	Upper Fuser Cleaning Roller	AR C 150, AR C 250	
NROLM1299FCZZ	45021728 	Upper Fuser Roller Silicone Based	AR C 250	
AR-C25UH	45023265 	Upper Fuser Roller Kit without Ball Bearings and Heat Sleeves Kit Contains: • (1) Upper Fuser Cleaning Roller • (1) Upper Fuser Roller	AR C 250	
PRNGP0051FCZZ	45011640 	V Ring	AR C 150, AR C 250	<i>Priced per Seal, sold in Bags of 4.</i>

Parts for use in Sharp AR C 160, AR C 270

NBRGY0131FCZZ	45576204 	Bearing Various Applications	AR C 160, AR C 270	
NBRGY0466FCZZ	45576233 	Bearing Various Applications	AR C 160, AR C 270	
UCLEZ0156FCZZ	45021493 	Drum Cleaning Blade	AR C 160, AR C 270	







For use in
Sharp
Copiers

Central/Eastern Europe
Telephone: 31(0)183-696969
Fax: 31(0)183-629055
E-mail: order@edc.katun.com









OEM PN	KATUN PN	DESCRIPTION	MODEL NO.	
Parts for use in Sharp AR C 160, AR C 270				
AR-C15SL	45021645 	Fuser Oil 800 g / Bottle	AR C 160, AR C 270	<i>Priced per Bottle, sold in Boxes of 6.</i>
NROLR1218FCZZ	45018450 	Paper Feed Roller	AR C 160, AR C 270	
NROLR1219FCZZ	45018451 	Paper Pickup Roller	AR C 160, AR C 270	
NROLR1219FCZZ	45021458 	Paper Pickup Roller Tire Only	AR C 160, AR C 270	<i>Priced per Tire, sold in Bags of 10.</i>
NROLR1229FCZZ	45018452 	Reverse Roller	AR C 160, AR C 270	
UCLEZ0157FCZZ	45021639 	Toner Seal Blade	AR C 160, AR C 270	
NROLN1249FCZZ	45021698 	Upper Fuser Cleaning Roller	AR C 160, AR C 270	
Parts for use in Sharp AR C 260				
NBRGY0466FCZZ	45576233 	Bearing	AR C 260	
NROLR1311FCZZ	45022788 	Paper Feed/Separation Roller	AR C 260	
NBRGY0646FCZZ	45021630 	Upper Fuser Roller Bearing	AR C 260	
Parts for use in Sharp AR C 260 M				
NBRGY0466FCZZ	45576233 	Bearing	AR C 260 M	
NROLR1311FCZZ	45022788 	Paper Feed/Separation Roller	AR C 260 M	
NBRGY0646FCZZ	45021630 	Upper Fuser Roller Bearing	AR C 260 M	
Parts for use in Sharp AR C 860				
OJE07403008//	45576205 	Bearing Various Applications	AR C 860	
OJE07423808//	45576233 	Bearing Various Applications	AR C 860	
OJEA1093598//	45014609 	Drum/Transfer Belt Cleaning Blade	AR C 860	
OJE54472927//	45014401 	Friction Pad B Cork Type	AR C 860	<i>Priced per Friction Pad, sold in Bags of 10.</i>

OEM PN	KATUN PN	DESCRIPTION	MODEL NO.
--------	----------	-------------	-----------

Parts for use in Sharp AR C 860

0JEAF031022//	45012104 	Paper Feed Roller Tire Only	AR C 860	<i>Priced per Tire, sold in Bags of 10.</i>
0JEAF030020//	45012106 	Paper Pickup Roller Tire Only	AR C 860	<i>Priced per Tire, sold in Bags of 10.</i>
0JEAF030021//	45632525 	Paper Pickup Roller Tire Only	AR C 860	<i>Priced per Tire, sold in Bags of 10.</i>
0JEAF032021//	45632523 	Separation Roller Tire Only	AR C 860	<i>Priced per Tire, sold in Bags of 10.</i>
0JEAF032023//	45012105 	Separation Roller Tire Only	AR C 860	<i>Priced per Tire, sold in Bags of 10.</i>
A2579550	45022278 	Silicone Fuser Oil 1000 ml / Bottle	AR C 860	<i>Priced per Bottle, sold in Boxes of 6.</i>
0JEAE030015//	45576217 	Upper Fuser Roller Bearing	AR C 860	

Parts for use in Sharp AR C 861, AR C 862

0JE07403008//	45576205 	Bearing Various Applications	AR C 861, AR C 862	
0JE07423808//	45576233 	Bearing Various Applications	AR C 861, AR C 862	
0JE54472927//	45014401 	Friction Pad B Cork Type	AR C 861, AR C 862	<i>Priced per Friction Pad, sold in Bags of 10.</i>
0JEAE020088//	45019179 	Lower Pressure Roller Silicone Based	AR C 861, AR C 862	
AX210037	45021484 	Magnetic Clutch	AR C 861, AR C 862	
0JEAF031022//	45012104 	Paper Feed Roller Tire Only	AR C 861, AR C 862	<i>Priced per Tire, sold in Bags of 10.</i>
0JEAF030020//	45012106 	Paper Pickup Roller Tire Only	AR C 861, AR C 862	<i>Priced per Tire, sold in Bags of 10.</i>
0JEAF030021//	45632525 	Paper Pickup Roller Tire Only	AR C 861, AR C 862	<i>Priced per Tire, sold in Bags of 10.</i>







For use in
Sharp
Copiers

Central/Eastern Europe
Telephone: 31(0)183-696969
Fax: 31(0)183-629055
E-mail: order@edc.katun.com

OEM PN	KATUN PN	DESCRIPTION	MODEL NO.
--------	----------	-------------	-----------





Parts for use in Sharp AR C 861, AR C 862

OJEAF032021//	45632523 	Separation Roller Tire Only	AR C 861, AR C 862	<i>Priced per Tire, sold in Bags of 10.</i>
OJEAF032023//	45012105 	Separation Roller Tire Only	AR C 861, AR C 862	<i>Priced per Tire, sold in Bags of 10.</i>
A2579550	45022278 	Silicone Fuser Oil 1000 ml / Bottle	AR C 861, AR C 862	<i>Priced per Bottle, sold in Boxes of 6.</i>
OJEAE010018//	45019178 	Upper Fuser Roller Silicone Based	AR C 861, AR C 862	
OJEAE030015//	45576217 	Upper Fuser Roller Bearing	AR C 861, AR C 862	

Parts for use in Sharp AR M 160

DWIR-0466CSZZ	45375548 	Corona Wire Spool 50 m / Spool 70µ Oxidized Transfer, Separation	AR M 160	
UCLEZ0009QSZ1	45017810 	Drum Cleaning Blade	AR M 160	
NROLR0031QSZ1	45019860 	Lower Pressure Roller MICROSLEEVE™	AR M 160	
AR-160UH	45018350 	Upper Fuser Roller	AR M 160	
NROLI0030QSZZ	45018350 	Upper Fuser Roller	AR M 160	
NBRGP0567FCZZ	45020088 	Upper Fuser Roller Bushing	AR M 160	<i>Priced per Bushing, sold in Bags of 10.</i>

Parts for use in Sharp AR M 205

DWIR-0466CSZZ	45375548 	Corona Wire Spool 50 m / Spool 70µ Oxidized Transfer, Separation	AR M 205	
UCLEZ0009QSZ1	45017810 	Drum Cleaning Blade	AR M 205	
NROLR0031QSZ1	45019860 	Lower Pressure Roller MICROSLEEVE™	AR M 205	
AR-160UH	45018350 	Upper Fuser Roller	AR M 205	



Katun Performance Product



















© 2004 Katun Corporation

OEM PN	KATUN PN	DESCRIPTION	MODEL NO.	
Parts for use in Sharp AR M 205				
NROLI0030QSZZ	45018350 	Upper Fuser Roller	AR M 205	
NBRGP0567FCZZ	45020088 	Upper Fuser Roller Bushing	AR M 205	<i>Priced per Bushing, sold in Bags of 10.</i>
Parts for use in Sharp AR M 208				
AR-270CB	45020916 	Cleaning Blade Kit	AR M 208	<i>Priced per Kit, 10 Blades per Kit.</i>
UCLEZ0011QSZZ	45020915 	Drum Cleaning Blade	AR M 208	
NBRGY0022QSZZ	45015954 	Lower Fuser Roller Bearing	AR M 208	
NROLR1051FCZZ	45012886 	Manual Paper Feed Roller Tire Only	AR M 208	<i>Priced per Tire, sold in Bags of 10.</i>
Parts for use in Sharp AR M 236				
AR-270CB	45020916 	Cleaning Blade Kit	AR M 236	<i>Priced per Kit, 10 Blades per Kit.</i>
UCLEZ0011QSZZ	45020915 	Drum Cleaning Blade	AR M 236	
NBRGY0022QSZZ	45015954 	Lower Fuser Roller Bearing	AR M 236	
NROLR1311FCZZ	45022788 	Paper Feed/Separation Roller	AR M 236	
NROLR1312FCZZ	45022789 	Paper Pickup Roller	AR M 236	
Parts for use in Sharp AR M 237				
AR-270CB	45020916 	Cleaning Blade Kit	AR M 237	<i>Priced per Kit, 10 Blades per Kit.</i>
UCLEZ0011QSZZ	45020915 	Drum Cleaning Blade	AR M 237	
NBRGY0022QSZZ	45015954 	Lower Fuser Roller Bearing	AR M 237	
NROLR1311FCZZ	45022788 	Paper Feed/Separation Roller	AR M 237	
NROLR1312FCZZ	45022789 	Paper Pickup Roller	AR M 237	



For use in
Sharp
Copiers

Central/Eastern Europe
Telephone: 31(0)183-696969
Fax: 31(0)183-629055
E-mail: order@edc.katun.com

OEM PN	KATUN PN	DESCRIPTION	MODEL NO.
Parts for use in Sharp AR M 276			
AR-270CB	45020916 	Cleaning Blade Kit	AR M 276
			<i>Priced per Kit, 10 Blades per Kit.</i>
UCLEZ0011QSZZ	45020915 	Drum Cleaning Blade	AR M 276
NBRGY0022QSZZ	45015954 	Lower Fuser Roller Bearing	AR M 276
NROLR1311FCZZ	45022788 	Paper Feed/Separation Roller	AR M 276
NROLR1312FCZZ	45022789 	Paper Pickup Roller	AR M 276
Parts for use in Sharp AR M 277			
AR-270CB	45020916 	Cleaning Blade Kit	AR M 277
			<i>Priced per Kit, 10 Blades per Kit.</i>
UCLEZ0011QSZZ	45020915 	Drum Cleaning Blade	AR M 277
NBRGY0022QSZZ	45015954 	Lower Fuser Roller Bearing	AR M 277
NROLR1311FCZZ	45022788 	Paper Feed/Separation Roller	AR M 277
NROLR1312FCZZ	45022789 	Paper Pickup Roller	AR M 277
Parts for use in Sharp AR M 350, AR M 450			
NBRGY0093FCZZ	45576205 	Bearing Various Applications	AR M 350, AR M 450
NBRGY0131FCZZ	45576204 	Bearing Various Applications	AR M 350, AR M 450
LPLTM5873FCZZ	45022696 	Charge Corona Grid	AR M 350, AR M 450
CCLEZ0162FC31	45021875 	Drum Cleaning Blade	AR M 350, AR M 450
NROLM1387FCZZ <i>Final Inventory</i>	45022662 	Fuser Cleaning Roller	AR M 350, AR M 450
NROLI1314FCZZ	45022829 	Lower Pressure Roller MICROSLEEVE™	AR M 350, AR M 450
NROLR1311FCZZ	45022788 	Paper Feed/Separation Roller	AR M 350, AR M 450
NROLR1312FCZZ	45022789 	Paper Pickup Roller	AR M 350, AR M 450



Katun Performance Product

© 2004 Katun Corporation











OEM PN	KATUN PN	DESCRIPTION	MODEL NO.
Parts for use in Sharp AR M 350, AR M 450			
NROLT1313FCZZ	45022892 	Upper Fuser Roller	AR M 350, AR M 450
NBRGY0646FCZZ	45021630 	Upper Fuser Roller Bearing	AR M 350, AR M 450
Parts for use in Sharp AR M 350 N			
NROLT1313FCZZ	45022892 	Upper Fuser Roller	AR M 350 N
Parts for use in Sharp AR M 350 NB			
NROLT1313FCZZ	45022892 	Upper Fuser Roller	AR M 350 NB
Parts for use in Sharp AR M 350 U			
NROLT1313FCZZ	45022892 	Upper Fuser Roller	AR M 350 U
Parts for use in Sharp AR M 350 UB			
NROLT1313FCZZ	45022892 	Upper Fuser Roller	AR M 350 UB
Parts for use in Sharp AR M 450 N			
NBRGY0093FCZZ	45576205 	Bearing Various Applications	AR M 450 N
NBRGY0131FCZZ	45576204 	Bearing Various Applications	AR M 450 N
LPLTM5873FCZZ	45022696 	Charge Corona Grid	AR M 450 N
CCLEZ0162FC31	45021875 	Drum Cleaning Blade	AR M 450 N
NROLM1387FCZZ <i>Final Inventory</i>	45022662 	Fuser Cleaning Roller	AR M 450 N
NROLI1314FCZZ	45022829 	Lower Pressure Roller MICROSLEEVE™	AR M 450 N
NROLR1311FCZZ	45022788 	Paper Feed/Separation Roller	AR M 450 N
NROLR1312FCZZ	45022789 	Paper Pickup Roller	AR M 450 N
NROLT1313FCZZ	45022892 	Upper Fuser Roller	AR M 450 N
NBRGY0646FCZZ	45021630 	Upper Fuser Roller Bearing	AR M 450 N

For use in
Sharp
Copiers











Central/Eastern Europe
Telephone: 31(0)183-696969
Fax: 31(0)183-629055
E-mail: order@edc.katun.com

OEM PN	KATUN PN	DESCRIPTION	MODEL NO.
-----------	-------------	-------------	--------------

Parts for use in Sharp AR M 450 N+

NBRGY0093FCZZ	45576205 	Bearing Various Applications	AR M 450 N+
NBRGY0131FCZZ	45576204 	Bearing Various Applications	AR M 450 N+
LPLTM5873FCZZ	45022696 	Charge Corona Grid	AR M 450 N+
CCLEZ0162FC31	45021875 	Drum Cleaning Blade	AR M 450 N+
NROLM1387FCZZ <i>Final Inventory</i>	45022662 	Fuser Cleaning Roller	AR M 450 N+
NROLI1314FCZZ	45022829 	Lower Pressure Roller MICROSLEEVE™	AR M 450 N+
NROLR1311FCZZ	45022788 	Paper Feed/Separation Roller	AR M 450 N+
NROLR1312FCZZ	45022789 	Paper Pickup Roller	AR M 450 N+
NROLT1313FCZZ	45022892 	Upper Fuser Roller	AR M 450 N+
NBRGY0646FCZZ	45021630 	Upper Fuser Roller Bearing	AR M 450 N+

Parts for use in Sharp AR M 450 NB

NBRGY0093FCZZ	45576205 	Bearing Various Applications	AR M 450 NB
NBRGY0131FCZZ	45576204 	Bearing Various Applications	AR M 450 NB
LPLTM5873FCZZ	45022696 	Charge Corona Grid	AR M 450 NB
CCLEZ0162FC31	45021875 	Drum Cleaning Blade	AR M 450 NB
NROLM1387FCZZ <i>Final Inventory</i>	45022662 	Fuser Cleaning Roller	AR M 450 NB
NROLI1314FCZZ	45022829 	Lower Pressure Roller MICROSLEEVE™	AR M 450 NB
NROLR1311FCZZ	45022788 	Paper Feed/Separation Roller	AR M 450 NB
NROLR1312FCZZ	45022789 	Paper Pickup Roller	AR M 450 NB
NROLT1313FCZZ	45022892 	Upper Fuser Roller	AR M 450 NB
NBRGY0646FCZZ	45021630 	Upper Fuser Roller Bearing	AR M 450 NB



Katun Performance Product

© 2004 Katun Corporation











26 October 2004

For the most current product and pricing information, visit the Katun On-Line Catalog at www.katun.com.











Prices, terms and conditions are subject to change without notice.

OEM PN	KATUN PN	DESCRIPTION	MODEL NO.
--------	----------	-------------	-----------

Parts for use in Sharp AR M 450 U





NBRGY0093FCZZ	45576205 	Bearing Various Applications	AR M 450 U
NBRGY0131FCZZ	45576204 	Bearing Various Applications	AR M 450 U
LPLTM5873FCZZ	45022696 	Charge Corona Grid	AR M 450 U
CCLEZ0162FC31	45021875 	Drum Cleaning Blade	AR M 450 U
NROLM1387FCZZ <i>Final Inventory</i>	45022662 	Fuser Cleaning Roller	AR M 450 U
NROLI1314FCZZ	45022829 	Lower Pressure Roller MICROSLEEVE™	AR M 450 U
NROLR1311FCZZ	45022788 	Paper Feed/Separation Roller	AR M 450 U
NROLR1312FCZZ	45022789 	Paper Pickup Roller	AR M 450 U
NROLT1313FCZZ	45022892 	Upper Fuser Roller	AR M 450 U
NBRGY0646FCZZ	45021630 	Upper Fuser Roller Bearing	AR M 450 U

Parts for use in Sharp AR M 450 U+

NBRGY0093FCZZ	45576205 	Bearing Various Applications	AR M 450 U+
NBRGY0131FCZZ	45576204 	Bearing Various Applications	AR M 450 U+
LPLTM5873FCZZ	45022696 	Charge Corona Grid	AR M 450 U+
CCLEZ0162FC31	45021875 	Drum Cleaning Blade	AR M 450 U+
NROLM1387FCZZ <i>Final Inventory</i>	45022662 	Fuser Cleaning Roller	AR M 450 U+
NROLI1314FCZZ	45022829 	Lower Pressure Roller MICROSLEEVE™	AR M 450 U+
NROLR1311FCZZ	45022788 	Paper Feed/Separation Roller	AR M 450 U+
NROLR1312FCZZ	45022789 	Paper Pickup Roller	AR M 450 U+
NROLT1313FCZZ	45022892 	Upper Fuser Roller	AR M 450 U+
NBRGY0646FCZZ	45021630 	Upper Fuser Roller Bearing	AR M 450 U+

For use in
Sharp
Copiers



Central/Eastern Europe
Telephone: 31(0)183-696969
Fax: 31(0)183-629055
E-mail: order@edc.katun.com

OEM PN	KATUN PN	DESCRIPTION	MODEL NO.
Parts for use in Sharp AR M 450 UB			
NBRGY0093FCZZ	45576205 	Bearing Various Applications	AR M 450 UB
NBRGY0131FCZZ	45576204 	Bearing Various Applications	AR M 450 UB
LPLTM5873FCZZ	45022696 	Charge Corona Grid	AR M 450 UB
CCLEZ0162FC31	45021875 	Drum Cleaning Blade	AR M 450 UB
NROLM1387FCZZ <i>Final Inventory</i>	45022662 	Fuser Cleaning Roller	AR M 450 UB
NROLI1314FCZZ	45022829 	Lower Pressure Roller MICROSLEEVE™	AR M 450 UB
NROLR1311FCZZ	45022788 	Paper Feed/Separation Roller	AR M 450 UB
NROLR1312FCZZ	45022789 	Paper Pickup Roller	AR M 450 UB
NROLT1313FCZZ	45022892 	Upper Fuser Roller	AR M 450 UB
NBRGY0646FCZZ	45021630 	Upper Fuser Roller Bearing	AR M 450 UB
Parts for use in Sharp AR M 550 N, AR M 550 U			
NBRGY0131FCZZ	45576204 	Bearing Various Applications	AR M 550 N, AR M 550 U
NBRGY0466FCZZ	45576233 	Bearing Various Applications	AR M 550 N, AR M 550 U
NBRGC0136FCZ1	45016755 	Sintered Bronze Bushing	AR M 550 N, AR M 550 U <i>Priced per Bushing, sold in Packages of 10.</i>
NBRGC0136FCZZ	45016755 	Sintered Bronze Bushing	AR M 550 N, AR M 550 U <i>Priced per Bushing, sold in Packages of 10.</i>
Parts for use in Sharp AR M 620 N, AR M 620 U			
NBRGY0131FCZZ	45576204 	Bearing Various Applications	AR M 620 N, AR M 620 U
NBRGY0466FCZZ	45576233 	Bearing Various Applications	AR M 620 N, AR M 620 U
NBRGC0136FCZ1	45016755 	Sintered Bronze Bushing	AR M 620 N, AR M 620 U <i>Priced per Bushing, sold in Packages of 10.</i>



Katun Performance Product













© 2004 Katun Corporation















OEM PN	KATUN PN	DESCRIPTION	MODEL NO.	
Parts for use in Sharp AR M 620 N, AR M 620 U				
NBRGC0136FCZZ	45016755 	Sintered Bronze Bushing	AR M 620 N, AR M 620 U	<i>Priced per Bushing, sold in Packages of 10.</i>
Parts for use in Sharp AR M 700 N, AR M 700 U				
NBRGY0131FCZZ	45576204 	Bearing Various Applications	AR M 700 N, AR M 700 U	
NBRGY0466FCZZ	45576233 	Bearing Various Applications	AR M 700 N, AR M 700 U	
NBRGC0136FCZ1	45016755 	Sintered Bronze Bushing	AR M 700 N, AR M 700 U	<i>Priced per Bushing, sold in Packages of 10.</i>
NBRGC0136FCZZ	45016755 	Sintered Bronze Bushing	AR M 700 N, AR M 700 U	<i>Priced per Bushing, sold in Packages of 10.</i>
Parts for use in Sharp CX 7500, CX 7700				
DWIR-0466CSZZ	45375548 	Corona Wire Spool 50 m / Spool 70µ Oxidized All Applications	CX 7500, CX 7700	
MSPRT0513FCZZ	45524654 	Corona Wire Spring Stainless Steel Various Applications	CX 7500, CX 7700	<i>Priced per Spring, sold in Bags of 10.</i>
NBRGC0136FCZZ	45016755 	Sintered Bronze Bushing	CX 7500	<i>Priced per Bushing, sold in Packages of 10.</i>
NBRGC0140FCZZ	45016756 	Sintered Bronze Bushing	CX 7500	<i>Priced per Bushing, sold in Packages of 10.</i>
NBRGY0255FCZZ	45021526 	Upper Fuser Roller Bearing	CX 7500, CX 7700	
Parts for use in Sharp DM 1500				
NROLR0922FCZZ	45016478 	Manual Paper Feed Roller	DM 1500	
CGUMM0288FC31	45014266 	Manual Paper Pickup Tire Tire Only	DM 1500	<i>Priced per Tire, sold in Bags of 10.</i>
Parts for use in Sharp DM 1505				
NROLR0922FCZZ	45016478 	Manual Paper Feed Roller	DM 1505	



For use in
Sharp
Copiers

Central/Eastern Europe
Telephone: 31(0)183-696969
Fax: 31(0)183-629055
E-mail: order@edc.katun.com

OEM PN	KATUN PN	DESCRIPTION	MODEL NO.	
Parts for use in Sharp DM 1505				
CGUMM0288FC31	45014266 	Manual Paper Pickup Tire Tire Only	DM 1505	<i>Priced per Tire, sold in Bags of 10.</i>
Parts for use in Sharp DM 2000, DM 2005, DM 2010, DM 2015				
AR-200CB	45019531 	Cleaning Blade Kit Includes: Front & Rear Side Seals	DM 2000, DM 2005, DM 2010, DM 2015	<i>Priced per Kit, 10 Blades per Kit.</i>
DWIR-0466CSZZ	45375548 	Corona Wire Spool 50 m / Spool 70µ Oxidized Transfer, Separation	DM 2000	
NROLR0031QSZ1	45019860 	Lower Pressure Roller MICROSLEEVE™	DM 2000	
NROLR0922FCZZ	45016478 	Manual Paper Feed Roller	DM 2000	
NROLR1051FCZZ	45012886 	Manual Paper Feed Roller Tire Only	DM 2005, DM 2010, DM 2015	<i>Priced per Tire, sold in Bags of 10.</i>
CGUMM0288FC31	45014266 	Manual Paper Pickup Tire Tire Only	DM 2000, DM 2005, DM 2010, DM 2015	<i>Priced per Tire, sold in Bags of 10.</i>
CROLP1115FC01	45014266 	Manual Pickup Roller Tire Only	DM 2000	<i>Priced per Tire, sold in Bags of 10.</i>
PGUMM0012QSZZ	45022795 	Paper Feed Tire Green Tire For PN:CSFTZ0066RS71	DM 2000, DM 2005, DM 2010, DM 2015	<i>Priced per Tire, sold in Bags of 10.</i>
NROLI0030QSZZ	45018350 	Upper Fuser Roller	DM 2000	
AR-160UH	45018350 	Upper Fuser Roller	DM 2000, DM 2005, DM 2010, DM 2015	
NBRGP0567FCZZ	45020088 	Upper Fuser Roller Bushing	DM 2000	<i>Priced per Bushing, sold in Bags of 10.</i>
Parts for use in Sharp SD 2060, SD 3062				
SD-360KA	45014406 	125K Maintenance Kit Kit Contains: • (1) Upper Fuser Cleaning Roller Assembly • (1) Lower Fuser Cleaning Roller Assembly • (1) Drum Cleaning Blade • (1) Waste Toner Bottle	SD 2060, SD 3062	

OEM PN	KATUN PN	DESCRIPTION	MODEL NO.
Parts for use in Sharp SD 2060, SD 3062			
SD-365KB	45014852 	250K PM Kit Kit Contains: <ul style="list-style-type: none"> • (1) Charge Plate • (1) Cleaning Unit Lower Seal • (2) Drum Picker Finger • (1) Corona Screen Grid • (1) Cleaning Unit Rear Side Seal • (1) Cleaning Unit Front Side Seal 	SD 2060, SD 3062
0CW2160P344A/	45576233 	Bearing Various Applications	SD 2060
NBRGY0131FCZZ	45576204 	Bearing Various Applications	SD 2060, SD 3062
NBRGY0466FCZZ	45576233 	Bearing Various Applications	SD 2060, SD 3062
CPLTM4129FC01	45011991 	Charge Plate	SD 2060, SD 3062
SF-216PU	45011991 	Charge Plate	SD 2060, SD 3062
CPLTZ4410FC02	45014390 	Corona Screen Grid Stainless Steel	SD 2060, SD 3062
SD-365SU	45014390 	Corona Screen Grid Stainless Steel	SD 2060, SD 3062
DWIR-0466CSZZ	45375548 	Corona Wire Spool 50 m / Spool 70μ Oxidized Transfer, Separation	SD 2060, SD 3062
DWIR-0467CSZZ	45375229 	Corona Wire Spool Platinum alloy clad technology extends corona wire life. 70μ 7.5 m / Spool Pretransfer	SD 2060, SD 3062
MSPRT0513FCZZ	45524654 	Corona Wire Spring Stainless Steel Various Applications	SD 2060, SD 3062
CCLEZ0125FC31	45011438 	Drum Cleaning Blade	SD 2060, SD 3062
SD-360CB	45012610 	Drum Cleaning Blade	SD 2060, SD 3062
PTME-0227FCZZ	45013791 	Drum Picker Finger	SD 2060, SD 3062
RLMPU0520FCZZ	45021144 	Exposure Lamp 115V 700W	SD 2060, SD 3062















*Priced per Spring,
 sold in Bags of 10.*

*Priced per Kit,
 10 Blades per Kit.*

*Priced per Picker Finger,
 sold in Bags of 2.*

For use in
Sharp
Copiers

Central/Eastern Europe
Telephone: 31(0)183-696969
Fax: 31(0)183-629055
E-mail: order@edc.katun.com

OEM PN	KATUN PN	DESCRIPTION	MODEL NO.
Parts for use in Sharp SD 2060, SD 3062			
LBSHC0334FCZZ	45014855 	Heat Insulating Sleeve	SD 2060, SD 3062
			<i>Priced per Set, 2 Heat Sleeves per Set.</i>
LBSHZ0178FCZ1	45014855 	Heat Insulating Sleeve	SD 2060, SD 3062
			<i>Priced per Set, 2 Heat Sleeves per Set.</i>
CROLN0973FC31	45011170 	Lower Fuser Cleaning Roller Assembly	SD 2060, SD 3062
SD-360RL	45011170 	Lower Fuser Cleaning Roller Assembly	SD 2060, SD 3062
SD-365RL	45011170 	Lower Fuser Cleaning Roller Assembly	SD 2060, SD 3062
NBRGY0487FCZZ	45016043 	Lower Fuser Roller Bearing	SD 2060, SD 3062
PTME-0174FCZ1	45018041 	Lower Picker Finger	SD 2060, SD 3062
			<i>Priced per Picker Finger, sold in Boxes of 10.</i>
NROLI0993FCZ1	45018874 	Lower Pressure Roller MICROSLEEVE™ PFA Sleeve extends life. A-Series Technology improves cleaning efficiency.	SD 2060, SD 3062
SD-360LH	45011615 	Lower Pressure Roller Kit MICROSLEEVE™ PFA Sleeve extends life. Kit Contains: • (1) Lower Pressure Roller • (4) Lower Picker Finger	SD 2060, SD 3062
N/P/N	45013264 	Manual Feed Replacement Kit Tire Only Kit Contains: • (2) Manual Pickup Tire • (2) Manual Reverse Tire • (2) Manual Feed Tire	SD 2060, SD 3062
NROLR0955FCZZ	45016477 	Manual Paper Feed Roller	SD 2060, SD 3062
NROLR0955FCZZ	45012756 	Manual Paper Feed Roller Tire Only	SD 2060, SD 3062
			<i>Priced per Tire, sold in Bags of 10.</i>
NROLR0964FCZZ	45017031 	Manual Reverse Roller	SD 2060, SD 3062
NROLR0964FCZZ	45013017 	Manual Reverse Roller Tire Only	SD 2060, SD 3062
			<i>Priced per Tire, sold in Bags of 10.</i>















Katun Performance Product

© 2004 Katun Corporation













OEM PN	KATUN PN	DESCRIPTION	MODEL NO.
Parts for use in Sharp SD 2060, SD 3062			
0CW2176P382A/	45011871 ◆	Original Document Feed Belt	SD 2060
0EUBLT0304D//	45016853 ◆	Original Document Feed Belt	SD 3062
0CW2148P095A/	45011310 ◆	Original Feed Roller Tire Only	SD 2060
			<i>Priced per Tire, sold in Bags of 10.</i>
0CW2148P096A/	45018143 ◆	Original Separation Roller Tire Only	SD 2060
			<i>Priced per Tire, sold in Bags of 10.</i>
PFILZ0200FCZ1 <i>Final Inventory</i>	45016652 ◆	Ozone Filter	SD 2060, SD 3062
PFILZ0201FCZ1 <i>Final Inventory</i>	45016651 ◆	Ozone Filter	SD 2060, SD 3062
NROLR0956FCZZ	45017035 ◆	Paper Pickup Roller Multi Feed Unit	SD 2060, SD 3062
NROLR0956FCZZ	45012782 ◆	Paper Pickup Roller Tire Only Multi Feed Unit	SD 2060, SD 3062
			<i>Priced per Tire, sold in Bags of 10.</i>
NBRGC0140FCZZ	45016756 ◆	Sintered Bronze Bushing	SD 2060, SD 3062
			<i>Priced per Bushing, sold in Packages of 10.</i>
CROLN0972FC32	45011169 ◆	Upper Fuser Cleaning Roller Assembly	SD 2060, SD 3062
SD-360RU	45011169 ◆	Upper Fuser Cleaning Roller Assembly	SD 2060, SD 3062
NROLT0971FCZZ	45011313 ◆	Upper Fuser Roller ALUMANA™ Patented TEFLON® coating with reinforcing oxides extends life.	SD 2060, SD 3062
NBRGY0479FCZ2	45015994 ◆	Upper Fuser Roller Bearing	SD 2060, SD 3062
NGERH0842FCZZ	45015022 ◆	Upper Fuser Roller Gear	SD 2060, SD 3062
SD-365UH	45016686 ◆	Upper Fuser Roller Kit Kit Contains: <ul style="list-style-type: none"> • (1) Upper Fuser Roller ALUMANA™ • (4) Upper Picker Finger • (2) Heat Insulating Sleeve • (1) Upper Fuser Roller Gear 	SD 2060, SD 3062
PTME-0226FCZZ	45012403 ◆	Upper Picker Finger	SD 2060, SD 3062
			<i>Priced per Picker Finger, sold in Packages of 4.</i>

For use in
Sharp
Copiers

Central/Eastern Europe
Telephone: 31(0)183-696969
Fax: 31(0)183-629055
E-mail: order@edc.katun.com

OEM PN	KATUN PN	DESCRIPTION	MODEL NO.	
Parts for use in Sharp SD 2060, SD 3062				
PRNGP0013FCZZ	45011640 	V Ring	SD 2060, SD 3062	<i>Priced per Seal, sold in Bags of 4.</i>
PRNGP0015FCZZ	45012311 	V Ring	SD 2060, SD 3062	<i>Priced per Bag, 4 Seals per Bag.</i>
CYOK-0040FC03	45014432 	Waste Toner Bottle	SD 2060, SD 3062	
Parts for use in Sharp SD 2075, SD 3076				
NBRGY0093FCZZ	45576205 	Bearing Various Applications	SD 2075, SD 3076	
NBRGY0131FCZZ	45576204 	Bearing Various Applications	SD 2075, SD 3076	
LPLTM4387FCZZ <i>Final Inventory</i>	45016707 	Corona Screen Grid	SD 2075, SD 3076	
DWIR-0467CSZZ	45375229 	Corona Wire Spool Platinum alloy clad technology extends corona wire life. 70µ 7.5 m / Spool All Applications	SD 2075, SD 3076	
MSPRT0513FCZZ	45524654 	Corona Wire Spring Stainless Steel Various Applications	SD 2075, SD 3076	<i>Priced per Spring, sold in Bags of 10.</i>
RLMPU0474FCZZ <i>Final Inventory</i>	45011437 	Exposure Lamp 170V 400W	SD 2075, SD 3076	
PGUMS0204FCZZ	45012481 	Original Feed Roller Tire Only Ribbed Tire	SD 2075	<i>Priced per Tire, sold in Bags of 10.</i>
NBRGC0136FCZZ	45016755 	Sintered Bronze Bushing	SD 2075, SD 3076	<i>Priced per Bushing, sold in Packages of 10.</i>
PRNGP0012FCZZ	45018027 	V Ring	SD 2075, SD 3076	<i>Priced per Seal, sold in Bags of 4.</i>
PRNGP0013FCZZ	45011640 	V Ring	SD 2075, SD 3076	<i>Priced per Seal, sold in Bags of 4.</i>

















OEM PN	KATUN PN	DESCRIPTION	MODEL NO.
Parts for use in Sharp SD 2260			
SD-365KA	45014554 	125K PM Kit Kit Contains: <ul style="list-style-type: none"> • (1) Lower Fuser Cleaning Roller Assembly • (1) Drum Cleaning Blade • (1) Waste Toner Bottle • (1) Upper Fuser Cleaning Roller Assembly 	SD 2260
SD-365KB	45014852 	250K PM Kit Kit Contains: <ul style="list-style-type: none"> • (1) Charge Plate • (1) Cleaning Unit Lower Seal • (2) Drum Picker Finger • (1) Corona Screen Grid • (1) Cleaning Unit Rear Side Seal • (1) Cleaning Unit Front Side Seal 	SD 2260
0CW2160P344//	45576233 	Bearing	SD 2260
NBRGY0131FCZZ	45576204 	Bearing Various Applications	SD 2260
NBRGY0466FCZZ	45576233 	Bearing Various Applications	SD 2260
CPLTM4129FC01	45011991 	Charge Plate	SD 2260
SF-216PU	45011991 	Charge Plate	SD 2260
CPLTZ4410FC02	45014390 	Corona Screen Grid Stainless Steel	SD 2260
SD-365SU	45014390 	Corona Screen Grid Stainless Steel	SD 2260
DWIR-0466CSZZ	45375548 	Corona Wire Spool 50 m / Spool 70μ Oxidized Transfer, Separation	SD 2260
DWIR-0467CSZZ	45375229 	Corona Wire Spool Platinum alloy clad technology extends corona wire life. 70μ 7.5 m / Spool Pretransfer	SD 2260
MSPRT0513FCZZ	45524654 	Corona Wire Spring Stainless Steel Various Applications	SD 2260
CCLEZ0125FC31	45011438 	Drum Cleaning Blade	SD 2260

*Priced per Spring,
 sold in Bags of 10.*

For use in
Sharp
Copiers















Central/Eastern Europe
Telephone: 31(0)183-696969
Fax: 31(0)183-629055
E-mail: order@edc.katun.com

OEM PN	KATUN PN	DESCRIPTION	MODEL NO.
Parts for use in Sharp SD 2260			
SD-360CB	45012610 	Drum Cleaning Blade	SD 2260
			<i>Priced per Kit, 10 Blades per Kit.</i>
PTME-0227FCZZ	45013791 	Drum Picker Finger	SD 2260
			<i>Priced per Picker Finger, sold in Bags of 2.</i>
RLMPU0520FCZZ	45021144 	Exposure Lamp 115V 700W	SD 2260
LBSHC0334FCZZ	45014855 	Heat Insulating Sleeve	SD 2260
			<i>Priced per Set, 2 Heat Sleeves per Set.</i>
CROLN0973FC31	45011170 	Lower Fuser Cleaning Roller Assembly	SD 2260
SD-360RL	45011170 	Lower Fuser Cleaning Roller Assembly	SD 2260
SD-365RL	45011170 	Lower Fuser Cleaning Roller Assembly	SD 2260
NBRGY0487FCZZ	45016043 	Lower Fuser Roller Bearing	SD 2260
PTME-0174FCZ1	45018041 	Lower Picker Finger	SD 2260
			<i>Priced per Picker Finger, sold in Boxes of 10.</i>
NROLI0993FCZ1	45018874 	Lower Pressure Roller MICROSLEEVE™ PFA Sleeve extends life. A-Series Technology improves cleaning efficiency.	SD 2260
SD-360LH	45011615 	Lower Pressure Roller Kit MICROSLEEVE™ PFA Sleeve extends life. Kit Contains: • (1) Lower Pressure Roller • (4) Lower Picker Finger	SD 2260
NROLR0955FCZZ	45016477 	Manual Paper Feed Roller	SD 2260
NROLR0955FCZZ	45012756 	Manual Paper Feed Roller Tire Only	SD 2260
			<i>Priced per Tire, sold in Bags of 10.</i>
NROLR0964FCZZ	45017031 	Manual Reverse Roller	SD 2260
NROLR0964FCZZ	45013017 	Manual Reverse Roller Tire Only	SD 2260
			<i>Priced per Tire, sold in Bags of 10.</i>

OEM PN	KATUN PN	DESCRIPTION	MODEL NO.	
Parts for use in Sharp SD 2260				
0CW2176P382//	45011871 	Original Document Feed Belt	SD 2260	
0CW2148P095//	45011310 	Original Feed Roller Tire Only	SD 2260	<i>Priced per Tire, sold in Bags of 10.</i>
0CW2222P302//	45019945 	Original Pickup Roller Tire Only Ribbed Tire	SD 2260	<i>Priced per Tire, sold in Bags of 10.</i>
0CW2148P096//	45018143 	Original Reverse Roller Tire Only	SD 2260	<i>Priced per Tire, sold in Bags of 10.</i>
NROLR0956FCZZ	45017035 	Paper Pickup Roller Multi Feed Unit	SD 2260	
NROLR0956FCZZ	45012782 	Paper Pickup Roller Tire Only Multi Feed Unit	SD 2260	<i>Priced per Tire, sold in Bags of 10.</i>
NBRGC0140FCZZ	45016756 	Sintered Bronze Bushing	SD 2260	<i>Priced per Bushing, sold in Packages of 10.</i>
CROLN1181FC31	45014818 	Upper Fuser Cleaning Roller Assembly	SD 2260	
SD-365RU	45014818 	Upper Fuser Cleaning Roller Assembly	SD 2260	
NROLT1183FCZZ	45011313 	Upper Fuser Roller ALUMANA™ Patented TEFLON® coating with reinforcing oxides extends life.	SD 2260	
NBRGY0479FCZZ	45015994 	Upper Fuser Roller Bearing	SD 2260	
NGERH1107FCZZ	45015022 	Upper Fuser Roller Gear	SD 2260	
SD-365UH	45016686 	Upper Fuser Roller Kit Kit Contains: • (1) Upper Fuser Roller ALUMANA™ • (4) Upper Picker Finger • (2) Heat Insulating Sleeve • (1) Upper Fuser Roller Gear	SD 2260	
PTME-0226FCZZ	45012403 	Upper Picker Finger	SD 2260	<i>Priced per Picker Finger, sold in Packages of 4.</i>
PRNGP0096FCZZ	45012311 	V Ring	SD 2260	<i>Priced per Bag, 4 Seals per Bag.</i>

For use in
Sharp
Copiers

Central/Eastern Europe
Telephone: 31(0)183-696969
Fax: 31(0)183-629055
E-mail: order@edc.katun.com

OEM PN	KATUN PN	DESCRIPTION	MODEL NO.	
Parts for use in Sharp SD 2260				
PRNGP0097FCZZ	45011640 	V Ring	SD 2260	<i>Priced per Seal, sold in Bags of 4.</i>
CYOK-0040FC03	45014432 	Waste Toner Bottle	SD 2260	
Parts for use in Sharp SD 2275				
0CW2160P344//	45576233 	Bearing	SD 2275	
NBRGY0131FCZZ	45576204 	Bearing Various Applications	SD 2275	
NBRGY0466FCZZ	45576233 	Bearing Various Applications	SD 2275	
CPLTM4129FC01	45011991 	Charge Plate	SD 2275	
SF-216PU	45011991 	Charge Plate	SD 2275	
CPLTZ4410FC02	45014390 	Corona Screen Grid Stainless Steel	SD 2275	
SD-365SU	45014390 	Corona Screen Grid Stainless Steel	SD 2275	
DWIR-0466CSZZ	45375548 	Corona Wire Spool 50 m / Spool 70μ Oxidized Transfer, Separation	SD 2275	
DWIR-0467CSZZ	45375229 	Corona Wire Spool Platinum alloy clad technology extends corona wire life. 70μ 7.5 m / Spool Pretransfer	SD 2275	
MSPRT0513FCZZ	45524654 	Corona Wire Spring Stainless Steel Various Applications	SD 2275	<i>Priced per Spring, sold in Bags of 10.</i>
CCLEZ0125FC31	45011438 	Drum Cleaning Blade	SD 2275	
SD-360CB	45012610 	Drum Cleaning Blade	SD 2275	<i>Priced per Kit, 10 Blades per Kit.</i>
PTME-0227FCZZ	45013791 	Drum Picker Finger	SD 2275	<i>Priced per Picker Finger, sold in Bags of 2.</i>











OEM PN	KATUN PN	DESCRIPTION	MODEL NO.
Parts for use in Sharp SD 2275			
LBSHC0334FCZZ	45014855 	Heat Insulating Sleeve	SD 2275
			<i>Priced per Set, 2 Heat Sleeves per Set.</i>
CROLN0973FC31	45011170 	Lower Fuser Cleaning Roller Assembly	SD 2275
SD-365RL	45011170 	Lower Fuser Cleaning Roller Assembly	SD 2275
PTME-0174FCZ1	45018041 	Lower Picker Finger	SD 2275
			<i>Priced per Picker Finger, sold in Boxes of 10.</i>
SD-475HR	45021562 	Lower Pressure Roller MICROSLEEVE™	SD 2275
NROLR0955FCZZ	45016477 	Manual Paper Feed Roller	SD 2275
NROLR0955FCZZ	45012756 	Manual Paper Feed Roller Tire Only	SD 2275
			<i>Priced per Tire, sold in Bags of 10.</i>
NROLR0964FCZZ	45017031 	Manual Reverse Roller	SD 2275
NROLR0964FCZZ	45013017 	Manual Reverse Roller Tire Only	SD 2275
			<i>Priced per Tire, sold in Bags of 10.</i>
0CW2176P382A/	45011871 	Original Document Feed Belt	SD 2275
0CW2148P095//	45011310 	Original Feed Roller Tire Only	SD 2275
			<i>Priced per Tire, sold in Bags of 10.</i>
0CW2222P302//	45019945 	Original Pickup Roller Tire Only Ribbed Tire	SD 2275
			<i>Priced per Tire, sold in Bags of 10.</i>
0CW2148P096//	45018143 	Original Reverse Roller Tire Only	SD 2275
			<i>Priced per Tire, sold in Bags of 10.</i>
NROLR0956FCZZ	45017035 	Paper Pickup Roller Multi Feed Unit	SD 2275
NROLR0956FCZZ	45012782 	Paper Pickup Roller Tire Only Multi Feed Unit	SD 2275
			<i>Priced per Tire, sold in Bags of 10.</i>
CROLN1181FC31	45014818 	Upper Fuser Cleaning Roller Assembly	SD 2275
NROLT1183FCZZ	45011313 	Upper Fuser Roller ALUMANA™ Patented TEFLON® coating with reinforcing oxides extends life.	SD 2275

For use in
Sharp
Copiers







Central/Eastern Europe
Telephone: 31(0)183-696969
Fax: 31(0)183-629055
E-mail: order@edc.katun.com

OEM PN	KATUN PN	DESCRIPTION	MODEL NO.
--------	----------	-------------	-----------

Parts for use in Sharp SD 2275

NBRGY0479FCZZ	45015994 	Upper Fuser Roller Bearing	SD 2275	
NGERH1107FCZZ	45015022 	Upper Fuser Roller Gear	SD 2275	
SD-365UH	45016686 	Upper Fuser Roller Kit Kit Contains: <ul style="list-style-type: none"> • (1) Upper Fuser Roller ALUMANA™ • (4) Upper Picker Finger • (2) Heat Insulating Sleeve • (1) Upper Fuser Roller Gear 	SD 2275	
PTME-0226FCZZ	45012403 	Upper Picker Finger	SD 2275	<i>Priced per Picker Finger, sold in Packages of 4.</i>
PRNGP0096FCZZ	45012311 	V Ring	SD 2275	<i>Priced per Bag, 4 Seals per Bag.</i>
PRNGP0097FCZZ	45011640 	V Ring	SD 2275	<i>Priced per Seal, sold in Bags of 4.</i>
PRNGP0099FCZZ	45018027 	V Ring	SD 2275	<i>Priced per Seal, sold in Bags of 4.</i>
CYOK-0040FC03	45014432 	Waste Toner Bottle	SD 2275	

Parts for use in Sharp SD 4085

NBRGP0573FCZZ	45576233 	Bearing Various Applications	SD 4085	
NBRGY0093FCZZ	45576205 	Bearing Various Applications	SD 4085	
NBRGY0131FCZZ	45576204 	Bearing Various Applications	SD 4085	
NBRGY0466FCZZ	45576233 	Bearing Various Applications	SD 4085	
DWIR-0466CSZZ	45375548 	Corona Wire Spool 50 m / Spool 70μ Oxidized Transfer, Separation	SD 4085	
DWIR-0467CSZZ	45375229 	Corona Wire Spool Platinum alloy clad technology extends corona wire life. 70μ 7.5 m / Spool	SD 4085	















Katun Performance Product

© 2004 Katun Corporation

OEM PN	KATUN PN	DESCRIPTION	MODEL NO.
-----------	-------------	-------------	--------------

Parts for use in Sharp SD 4085







MSPRT0513FCZZ	45524654 	Corona Wire Spring Stainless Steel Various Applications	SD 4085	<i>Priced per Spring, sold in Bags of 10.</i>
RLMPU0474FCZZ <i>Final Inventory</i>	45011437 	Exposure Lamp 170V 400W	SD 4085	
NROLR1049FCZZ	45016482 	Paper Feed Roller	SD 4085	
NROLR1049FCZZ	45012632 	Paper Feed Roller Tire Only	SD 4085	<i>Priced per Tire, sold in Bags of 10.</i>
NBRGC0136FCZZ	45016755 	Sintered Bronze Bushing	SD 4085	<i>Priced per Bushing, sold in Packages of 10.</i>
NBRGC0140FCZZ	45016756 	Sintered Bronze Bushing	SD 4085	<i>Priced per Bushing, sold in Packages of 10.</i>
NROLT1130FCZZ <i>Final Inventory</i>	45016998 	Upper Fuser Roller	SD 4085	
SD-485UH <i>Final Inventory</i>	45016998 	Upper Fuser Roller	SD 4085	
PRNGP0013FCZZ	45011640 	V Ring	SD 4085	<i>Priced per Seal, sold in Bags of 4.</i>
PRNGP0051FCZZ	45011640 	V Ring	SD 4085	<i>Priced per Seal, sold in Bags of 4.</i>
PRNGP0063FCZZ	45018027 	V Ring	SD 4085	<i>Priced per Seal, sold in Bags of 4.</i>
PRNGP0069FCZZ	45018026 	V Ring	SD 4085	<i>Priced per Seal, sold in Bags of 4.</i>







Parts for use in Sharp SF 740, SF 741











N/P/N	45375228 	Corona Wire Spool Platinum alloy clad technology extends corona wire life. 60μ 7.5 m / Spool All Applications	SF 740, SF 741	
-------	---	--	----------------	--

For use in
Sharp
Copiers

Central/Eastern Europe
Telephone: 31(0)183-696969
Fax: 31(0)183-629055
E-mail: order@edc.katun.com







OEM PN	KATUN PN	DESCRIPTION	MODEL NO.	
Parts for use in Sharp SF 750				
DWIR-0466CSZZ	45375548 	Corona Wire Spool 50 m / Spool 70μ Oxidized All Applications	SF 750	
MSPRT0513FCZZ	45524654 	Corona Wire Spring Stainless Steel Various Applications	SF 750	<i>Priced per Spring, sold in Bags of 10.</i>
NBRGC0136FCZZ	45016755 	Sintered Bronze Bushing	SF 750	<i>Priced per Bushing, sold in Packages of 10.</i>
NBRGC0140FCZZ	45016756 	Sintered Bronze Bushing	SF 750	<i>Priced per Bushing, sold in Packages of 10.</i>
NBRGP0146FCZZ	45576209 	Upper Fuser Roller Bearing	SF 750	
PRNGP0013FCZZ	45011640 	V Ring	SF 750	<i>Priced per Seal, sold in Bags of 4.</i>
PRNGP0015FCZZ	45012311 	V Ring	SF 750	<i>Priced per Bag, 4 Seals per Bag.</i>







Parts for use in Sharp SF 755, SF 756, SF 760				
DWIR-0466CSZZ	45375548 	Corona Wire Spool 50 m / Spool 70μ Oxidized All Applications Charge, Transfer	SF 755, SF 756 SF 760	
DWIR-0522CSZZ	45375558 	Corona Wire Spool 50 m / Spool 80μ Unpolished Separation	SF 760	
MSPRT0513FCZZ	45524654 	Corona Wire Spring Stainless Steel Various Applications	SF 755, SF 756, SF 760	<i>Priced per Spring, sold in Bags of 10.</i>
NBRGC0136FCZZ	45016755 	Sintered Bronze Bushing	SF 755, SF 760	<i>Priced per Bushing, sold in Packages of 10.</i>
NBRGC0140FCZZ	45016756 	Sintered Bronze Bushing	SF 755, SF 760	<i>Priced per Bushing, sold in Packages of 10.</i>
NBRGP0146FCZZ	45576209 	Upper Fuser Roller Bearing	SF 755, SF 756, SF 760	

OEM PN	KATUN PN	DESCRIPTION	MODEL NO.	
Parts for use in Sharp SF 755, SF 756, SF 760				
PRNGP0013FCZZ	45011640 	V Ring	SF 755, SF 756	<i>Priced per Seal, sold in Bags of 4.</i>
PRNGP0015FCZZ	45012311 	V Ring	SF 755, SF 756	<i>Priced per Bag, 4 Seals per Bag.</i>
Parts for use in Sharp SF 770, SF 771, SF 780, SF 781, SF 7400				
NBRGY0131FCZZ	45576204 	Bearing Various Applications	SF 770, SF 771, SF 780, SF 781	
DWIR-0466CSZZ	45375548 	Corona Wire Spool 50 m / Spool 70μ Oxidized All Applications	SF 770, SF 771, SF 780, SF 781	
MSPRT0513FCZZ	45524654 	Corona Wire Spring Stainless Steel Various Applications	SF 770, SF 771, SF 780, SF 781, SF 7400	<i>Priced per Spring, sold in Bags of 10.</i>
NBRGY0213FCZZ	45576209 	Upper Fuser Roller Bearing	SF 770, SF 771, SF 780, SF 781	
PRNGP0012FCZZ	45018027 	V Ring	SF 770, SF 771, SF 780, SF 781	<i>Priced per Seal, sold in Bags of 4.</i>
PRNGP0015FCZZ	45012311 	V Ring	SF 770, SF 771, SF 780, SF 781	<i>Priced per Bag, 4 Seals per Bag.</i>
Parts for use in Sharp SF 810, SF 810 CN, SF 811, SF 811 CN, SF 820, SF 850				
DWIR-0466CSZZ	45375548 	Corona Wire Spool 50 m / Spool 70μ Oxidized All Applications	SF 810, SF 810 CN, SF 811, SF 811 CN, SF 820, SF 850	
DWIR-0467CSZZ	45375229 	Corona Wire Spool Platinum alloy clad technology extends corona wire life. 70μ 7.5 m / Spool All Applications	SF 810, SF 810 CN, SF 811, SF 811 CN, SF 820, SF 850	
MSPRT0513FCZZ	45524654 	Corona Wire Spring Stainless Steel Various Applications	SF 811, SF 811 CN, SF 820, SF 850	<i>Priced per Spring, sold in Bags of 10.</i>

For use in
Sharp
Copiers

Central/Eastern Europe
Telephone: 31(0)183-696969
Fax: 31(0)183-629055
E-mail: order@edc.katun.com















OEM PN	KATUN PN	DESCRIPTION	MODEL NO.	
Parts for use in Sharp SF 815, SF 815 CN, SF 816, SF 825, SF 826				
NBRGY0131FCZZ	45576204 	Bearing Various Applications	SF 815, SF 815 CN, SF 816, SF 825, SF 826	
DWIR-0466CSZZ	45375548 	Corona Wire Spool 50 m / Spool 70μ Oxidized All Applications	SF 815, SF 815 CN, SF 816, SF 825, SF 826	
DWIR-0467CSZZ	45375229 	Corona Wire Spool Platinum alloy clad technology extends corona wire life. 70μ 7.5 m / Spool All Applications	SF 815, SF 815 CN, SF 816, SF 825, SF 826	
MSPRT0513FCZZ	45524654 	Corona Wire Spring Stainless Steel Various Applications	SF 815, SF 815 CN, SF 816, SF 825, SF 826	<i>Priced per Spring, sold in Bags of 10.</i>
NBRGY0213FCZZ	45576209 	Upper Fuser Roller Bearing	SF 815, SF 815 CN, SF 816, SF 825, SF 826	
PRNGP0012FCZZ	45018027 	V Ring	SF 815, SF 815 CN, SF 816, SF 825, SF 826	<i>Priced per Seal, sold in Bags of 4.</i>
PRNGP0013FCZZ	45011640 	V Ring	SF 815, SF 815 CN, SF 816, SF 825, SF 826	<i>Priced per Seal, sold in Bags of 4.</i>

Parts for use in Sharp SF 900, SF 901				
NBRGY0131FCZZ	45576204 	Bearing Various Applications	SF 900, SF 901	
DWIR-0466CSZZ	45375548 	Corona Wire Spool 50 m / Spool 70μ Oxidized All Applications	SF 900, SF 901	
DWIR-0467CSZZ	45375229 	Corona Wire Spool Platinum alloy clad technology extends corona wire life. 70μ 7.5 m / Spool All Applications	SF 900, SF 901	
MSPRT0513FCZZ	45524654 	Corona Wire Spring Stainless Steel Various Applications	SF 900, SF 901	<i>Priced per Spring, sold in Bags of 10.</i>
NBRGC0136FCZZ	45016755 	Sintered Bronze Bushing	SF 900	<i>Priced per Bushing, sold in Packages of 10.</i>
NBRGY0213FCZZ	45576209 	Upper Fuser Roller Bearing	SF 900, SF 901	



Katun Performance Product















© 2004 Katun Corporation

OEM PN	KATUN PN	DESCRIPTION	MODEL NO.
Parts for use in Sharp SF 900, SF 901			
PRNGP0013FCZZ	45011640 	V Ring	SF 900, SF 901
<i>Priced per Seal, sold in Bags of 4.</i>			
Parts for use in Sharp SF 1016, SF 1018, SF 1020, SF 2116, SF 2118			
CPLTM4129FC01	45011991 	Charge Plate	SF 1016, SF 1018, SF 1020, SF 2116, SF 2118
SF-216PU	45011991 	Charge Plate	SF 1016, SF 1018, SF 1020, SF 2116, SF 2118
LPLTZ4069FCZZ	45013151 	Corona Screen Grid	SF 1016, SF 1018, SF 1020, SF 2116, SF 2118
DWIR-0466CSZZ	45375548 	Corona Wire Spool 50 m / Spool 70µ Oxidized Transfer, Separation	SF 1016, SF 1018, SF 1020, SF 2116, SF 2118
UCLEZ0108FCZ1	45000401 	Drum Cleaning Blade	SF 1016, SF 1018, SF 1020, SF 2116, SF 2118
UCLEZ0108FCZ1	45022580	Drum Cleaning Blade Access By Katun	SF 1016, SF 1018, SF 1020, SF 2116, SF 2118
PTME-0211FCZ1	45020110 	Drum Picker Finger	SF 1016, SF 1018, SF 1020, SF 2116, SF 2118
<i>Priced per Picker Finger, sold in Packages of 2.</i>			
RLMPU0495FCZ1	45021123 	Exposure Lamp 170V 310W	SF 1016, SF 1018, SF 1020, SF 2116, SF 2118
CBRGP0525FC02	45014520 	Front Fuser Roller Bushing	SF 1016, SF 1018, SF 1020, SF 2116, SF 2118
<i>Priced per Bushing, sold in Bags of 10.</i>			
RLMPU0551FCZZ	45021096 	Heater Lamp 220V 1000W	SF 1016, SF 1018, SF 1020, SF 2116, SF 2118
PTME-0244FCZZ	45013951 	Lower Picker Finger	SF 1016, SF 1018, SF 1020, SF 2116, SF 2118
<i>Priced per Picker Finger, sold in Bags of 2.</i>			
NROLR1058FCZ3	45012885 	Lower Pressure Roller MICROSLEEVE™	SF 1016, SF 1018, SF 1020, SF 2116, SF 2118
SF-216HR	45012885 	Lower Pressure Roller MICROSLEEVE™	SF 1016, SF 1018, SF 2116, SF 2118
SF-220LH	45015435 	Lower Pressure Roller Kit Kit Contains: • (1) Lower Pressure Roller MICROSLEEVE™ • (4) Lower Picker Finger	SF 1020



For use in
Sharp
Copiers

Central/Eastern Europe
Telephone: 31(0)183-696969
Fax: 31(0)183-629055
E-mail: order@edc.katun.com

OEM PN	KATUN PN	DESCRIPTION	MODEL NO.
Parts for use in Sharp SF 1016, SF 1018, SF 1020, SF 2116, SF 2118			
SF-216LH	45014025 	Lower Pressure Roller Kit Kit Contains: • (1) Lower Pressure Roller MICROSLEEVE™ • (2) Lower Picker Finger	SF 1016, SF 1018, SF 2116, SF 2118
NROLR1049FCZ1	45016482 	Paper Feed Roller	SF 1016, SF 1018, SF 1020, SF 2116, SF 2118
NROLR1049FCZ1	45012632 	Paper Feed Roller Tire Only	SF 1016, SF 1018, SF 1020, SF 2116, SF 2118
NROLR0878FCZZ	45017032 	Paper Pickup Roller	SF 1016, SF 1018, SF 1020, SF 2116, SF 2118
NROLR0878FCZZ	45011076 	Paper Pickup Roller Tire Only	SF 1016, SF 1018, SF 1020, SF 2116, SF 2118
CBRGP0528FC02	45014521 	Rear Fuser Roller Bushing	SF 1016, SF 1018, SF 1020, SF 2116, SF 2118
NBRGC0136FCZ1	45016755 	Sintered Bronze Bushing	SF 1016, SF 1018, SF 2116, SF 2118
NBRGC0136FCZZ	45016755 	Sintered Bronze Bushing	SF 1016, SF 1018, SF 2116, SF 2118
NROLT1063FCZ2	45013027 	Upper Fuser Roller DURACON™ II	SF 1020
NROLT1063FCZZ	45013027 	Upper Fuser Roller DURACON™ II	SF 1016, SF 1018, SF 2116, SF 2118
SF-216HU	45013027 	Upper Fuser Roller DURACON™ II	SF 1020, SF 2116, SF 2118
NGERH1214FCZZ	45012819 	Upper Fuser Roller Gear	SF 1020
NGERH0443FCZ1	45012819 	Upper Fuser Roller Gear	SF 1016, SF 1018, SF 2116, SF 2118
SF-216UH	45015481 	Upper Fuser Roller Kit Kit Contains: • (1) Upper Fuser Roller Gear • (2) Roller Stopper • (1) Upper Fuser Roller DURACON™ II • (4) Upper Picker Finger • (1) Front Fuser Roller Bushing • (1) Rear Fuser Roller Bushing	SF 1020, SF 2116, SF 2118











*Priced per Tire,
sold in Bags of 10.*

*Priced per Tire,
sold in Bags of 10.*

*Priced per Bushing,
sold in Bags of 10.*

*Priced per Bushing,
sold in Packages of 10.*

*Priced per Bushing,
sold in Packages of 10.*

OEM PN	KATUN PN	DESCRIPTION	MODEL NO.
Parts for use in Sharp SF 1016, SF 1018, SF 1020, SF 2116, SF 2118			
PTME-0168FCZZ	45013096 	Upper Picker Finger	SF 1016, SF 1018, SF 1020, SF 2116, SF 2118 <i>Priced per Picker Finger, sold in Packages of 10.</i>
PRNGP0050FCZZ	45012311 	V Ring	SF 1016, SF 1018, SF 2116, SF 2118 <i>Priced per Bag, 4 Seals per Bag.</i>
Parts for use in Sharp SF 1025, SF 2022, SF 2022 N, SF 2027, SF 2027 N			
SF-222KB	45016193 	160K Maintenance Kit Kit Contains: <ul style="list-style-type: none"> • (1) Lower Pressure Roller • (1) Upper Fuser Roller Gear • (1) Upper Fuser Roller • (1) Toner Seal • (1) Developer Unit Seal 	SF 1025, SF 2022, SF 2022 N, SF 2027, SF 2027 N
SF-222KA	45014403 	80K Maintenance Kit Kit Contains: <ul style="list-style-type: none"> • (1) Charge Plate • (2) Drum Picker Finger • (2) Lower Picker Finger • (4) Upper Picker Finger • (1) Upper Fuser Cleaning Roller Assembly • (1) Drum Cleaning Blade • (4) Waste Toner Bottle • (1) Corona Screen Grid 	SF 1025, SF 2022, SF 2022 N, SF 2027, SF 2027 N
NBRGY0466FCZZ	45576233 	Bearing Various Applications	SF 1025, SF 2022, SF 2022 N, SF 2027, SF 2027 N
CPLTM4129FC01	45011991 	Charge Plate	SF 1025, SF 2022, SF 2022 N, SF 2027, SF 2027 N
SF-216PU	45011991 	Charge Plate	SF 1025, SF 2022, SF 2022 N, SF 2027, SF 2027 N
LPLTZ4069FCZZ	45013151 	Corona Screen Grid	SF 1025, SF 2022, SF 2022 N, SF 2027, SF 2027 N
DWIR-0466CSZZ	45375548 	Corona Wire Spool 50 m / Spool 70µ Oxidized Transfer, Separation	SF 1025, SF 2022, SF 2022 N, SF 2027, SF 2027 N
MSPRT0513FCZZ	45524654 	Corona Wire Spring Stainless Steel Various Applications	SF 1025, SF 2022, SF 2022 N, SF 2027, SF 2027 N <i>Priced per Spring, sold in Bags of 10.</i>
UCLEZ0136FCZZ	45014743 	Developer Unit Seal	SF 2022, SF 2022 N, SF 2027, SF 2027 N

For use in
Sharp
Copiers

Central/Eastern Europe
Telephone: 31(0)183-696969
Fax: 31(0)183-629055
E-mail: order@edc.katun.com

OEM PN	KATUN PN	DESCRIPTION	MODEL NO.
Parts for use in Sharp SF 1025, SF 2022, SF 2022 N, SF 2027, SF 2027 N			
CCLEZ0117FC31	45010155	Drum Cleaning Blade	SF 1025, SF 2022, SF 2022 N, SF 2027, SF 2027 N
CCLEZ0117FC31	45022581	Drum Cleaning Blade Access By Katun	SF 1025, SF 2022, SF 2022 N, SF 2027, SF 2027 N
SF-222BL	45010155	Drum Cleaning Blade	SF 2022, SF 2022 N, SF 2027, SF 2027 N
CDAIU0451FC51	45020110	Drum Picker Finger Assembly	SF 1025, SF 2022, SF 2022 N, SF 2027, SF 2027 N
			<i>Priced per Picker Finger, sold in Packages of 2.</i>
RLMPU0495FCZZ	45021123	Exposure Lamp 170V 310W	SF 1025, SF 2022, SF 2022 N, SF 2027, SF 2027 N
N/P/N	45019752	Feed Roller Replacement Kit New Style Kit Contains: • (1) Paper Feed Roller • (1) Paper Pickup Roller • (1) Reverse Roller	SF 2022, SF 2022 N, SF 2027, SF 2027 N
N/P/N	45012325	Feed Tire Replacement Kit Tire Only Old Style Kit Contains: • (1) Manual Pickup Tire • (2) Separation/Feed Tire	SF 1025, SF 2022, SF 2022 N, SF 2027, SF 2027 N
LBSHC0228FCZZ	45012446	Heat Insulating Sleeve	SF 1025, SF 2022, SF 2022 N, SF 2027, SF 2027 N
			<i>Priced per Heat Sleeve, sold in Bags of 10.</i>
RLMPU0489FCZZ	45021087	Heater Lamp 220V 900W	SF 1025, SF 2022, SF 2022 N, SF 2027, SF 2027 N
NBRGY0296FCZZ	45013093	Lower Fuser Roller Bearing	SF 1025, SF 2022, SF 2022 N, SF 2027, SF 2027 N
PTME-0174FCZ1	45018041	Lower Picker Finger	SF 1025, SF 2022, SF 2022 N, SF 2027, SF 2027 N
			<i>Priced per Picker Finger, sold in Boxes of 10.</i>
NROLI0583FCZZ	45013214	Lower Pressure Roller MICROSLEEVE™	SF 1025, SF 2022, SF 2022 N, SF 2027, SF 2027 N
NROLI0583FCZZ	45636769	Lower Pressure Roller	SF 1025, SF 2022, SF 2022 N, SF 2027, SF 2027 N
NROLR0922FCZZ	45016478	Manual Paper Feed Roller	SF 1025, SF 2022, SF 2022 N, SF 2027, SF 2027 N
CGUMM0286FC31	45009690	Manual Paper Feed Tire Tire Only	SF 1025, SF 2022, SF 2022 N, SF 2027
			<i>Priced per Tire, sold in Bags of 10.</i>



Katun Performance Product

















© 2004 Katun Corporation

26 October 2004

For the most current product and pricing information, visit the Katun On-Line Catalog at www.katun.com.















Prices, terms and conditions are subject to change without notice.

75

OEM PN	KATUN PN	DESCRIPTION	MODEL NO.	
Parts for use in Sharp SF 1025, SF 2022, SF 2022 N, SF 2027, SF 2027 N				
CROLP0921FC01	45017033 	Manual Pickup Roller	SF 2022, SF 2022 N, SF 2027, SF 2027 N	
CROLP0921FC01	45011442 	Manual Pickup Roller Tire Only Ribbed Tire	SF 2022, SF 2022 N, SF 2027, SF 2027 N	<i>Priced per Tire, sold in Bags of 10.</i>
CSFTZ1771FC31	45011357 	Manual Reverse Roller Assembly Tire Only	SF 2022, SF 2022 N, SF 2027, SF 2027 N	<i>Priced per Tire, sold in Bags of 10.</i>
NROLR0901FCZZ	45016481 	Paper Feed Roller	SF 1025, SF 2022, SF 2022 N, SF 2027, SF 2027 N	
NROLR0901FCZZ	45011352 	Paper Feed Roller Tire Only	SF 1025, SF 2022, SF 2022 N, SF 2027, SF 2027 N	<i>Priced per Tire, sold in Bags of 10.</i>
NROLR0986FCZZ	45020763 	Paper Feed Roller Tire Only For duplex unit only	SF 1025, SF 2022, SF 2022 N, SF 2027, SF 2027 N	<i>Priced per Tire, sold in Bags of 10.</i>
NROLR0986FCZZ	45011352 	Paper Feed Roller Tire Only	SF 1025, SF 2022, SF 2022 N, SF 2027, SF 2027 N	<i>Priced per Tire, sold in Bags of 10.</i>
NROLR1049FCZZ	45016482 	Paper Feed Roller	SF 2022, SF 2022 N, SF 2027, SF 2027 N	
NROLR1049FCZZ	45012632 	Paper Feed Roller Tire Only	SF 2022, SF 2022 N, SF 2027, SF 2027 N	<i>Priced per Tire, sold in Bags of 10.</i>
NROLR1218FCZZ	45018450 	Paper Feed Roller	SF 2022, SF 2022 N, SF 2027, SF 2027 N	
NROLR0920FCZZ	45016480 	Paper Pickup Roller	SF 1025, SF 2022, SF 2022 N, SF 2027, SF 2027 N	
NROLR0920FCZZ	45011442 	Paper Pickup Roller Tire Only Ribbed Tire	SF 1025, SF 2022, SF 2022 N, SF 2027, SF 2027 N	<i>Priced per Tire, sold in Bags of 10.</i>
NROLR1219FCZZ	45018451 	Paper Pickup Roller	SF 2022, SF 2022 N, SF 2027, SF 2027 N	
NROLR1219FCZZ	45021458 	Paper Pickup Roller Tire Only	SF 2022, SF 2022 N, SF 2027, SF 2027 N	<i>Priced per Tire, sold in Bags of 10.</i>
NROLR1229FCZZ	45018452 	Reverse Roller	SF 2022, SF 2022 N, SF 2027, SF 2027 N	
NROLR0902FCZZ	45016479 	Separation Roller	SF 1025, SF 2022, SF 2022 N, SF 2027, SF 2027 N	
NROLR0902FCZZ	45011352 	Separation Roller Tire Only	SF 1025, SF 2022, SF 2022 N, SF 2027, SF 2027 N	<i>Priced per Tire, sold in Bags of 10.</i>

For use in
Sharp
Copiers

Central/Eastern Europe
Telephone: 31(0)183-696969
Fax: 31(0)183-629055
E-mail: order@edc.katun.com

OEM PN	KATUN PN	DESCRIPTION	MODEL NO.	
Parts for use in Sharp SF 1025, SF 2022, SF 2022 N, SF 2027, SF 2027 N				
NBRGC0136FCZZ	45016755 	Sintered Bronze Bushing	SF 1025, SF 2022, SF 2022 N, SF 2027, SF 2027 N	<i>Priced per Bushing, sold in Packages of 10.</i>
NBRGC0140FCZZ	45016756 	Sintered Bronze Bushing	SF 1025, SF 2022, SF 2022 N, SF 2027, SF 2027 N	<i>Priced per Bushing, sold in Packages of 10.</i>
UCLEZ0118FCZZ	45013005 	Toner Seal	SF 1025, SF 2022, SF 2022 N, SF 2027, SF 2027 N	
CROLN0935FC31	45016768 	Upper Fuser Cleaning Roller Assembly	SF 1025, SF 2022, SF 2022 N, SF 2027, SF 2027 N	
NROLT0913FCZ1	45014437 	Upper Fuser Roller ALUMANA™ Patented TEFLON® coating with reinforcing oxides extends life.	SF 1025, SF 2022, SF 2022 N, SF 2027, SF 2027 N	
NROLT0913FCZ1	45014840	Upper Fuser Roller Access By Katun	SF 1025, SF 2022, SF 2022 N, SF 2027, SF 2027 N	
NBRGY0295FCZZ	45576217 	Upper Fuser Roller Bearing	SF 1025, SF 2022, SF 2022 N, SF 2027, SF 2027 N	
N/P/N	45012816 	Upper Fuser Roller Bearing Kit Kit Contains: • (2) Heat Insulating Sleeve • (2) Upper Fuser Roller Bearing Kit	SF 1025, SF 2022, SF 2022 N, SF 2027, SF 2027 N	
NGERH0475FCZ1	45012825 	Upper Fuser Roller Gear	SF 1025, SF 2022, SF 2022 N, SF 2027, SF 2027 N	
PTME-0168FCZZ	45013096 	Upper Picker Finger	SF 1025, SF 2022, SF 2022 N, SF 2027, SF 2027 N	<i>Priced per Picker Finger, sold in Packages of 10.</i>
PRNGP0013FCZZ	45011640 	V Ring	SF 1025, SF 2022, SF 2022 N, SF 2027, SF 2027 N	<i>Priced per Seal, sold in Bags of 4.</i>
PRNGP0015FCZZ	45012311 	V Ring	SF 1025, SF 2022, SF 2022 N, SF 2027, SF 2027 N	<i>Priced per Bag, 4 Seals per Bag.</i>
CYOK-0039FC01	45014388 	Waste Toner Bottle	SF 1025, SF 2022, SF 2022 N, SF 2027, SF 2027 N	
Parts for use in Sharp SF 1116				
CPLTM4129FC01	45011991 	Charge Plate	SF 1116	
SF-216PU	45011991 	Charge Plate	SF 1116	
LPLTZ5474FCZZ	45013151 	Corona Screen Grid	SF 1116	



Katun Performance Product













© 2004 Katun Corporation

OEM PN	KATUN PN	DESCRIPTION	MODEL NO.
Parts for use in Sharp SF 1116			
DWIR-0466CSZZ	45375548 	Corona Wire Spool 50 m / Spool 70µ Oxidized Transfer, Separation	SF 1116
UCLEZ0108FCZ1	45000401 	Drum Cleaning Blade	SF 1116
UCLEZ0108FCZ1	45022580	Drum Cleaning Blade Access By Katun	SF 1116
PTME-0211FCZ1	45020110 	Drum Picker Finger	SF 1116
			<i>Priced per Picker Finger, sold in Packages of 2.</i>
RLMPU0495FCZ1	45021123 	Exposure Lamp 170V 310W	SF 1116
CBRGP0525FC02	45014520 	Front Fuser Roller Bushing	SF 1116
			<i>Priced per Bushing, sold in Bags of 10.</i>
RLMPU0551FCZZ	45021096 	Heater Lamp 220V 1000W	SF 1116
PTME-0244FCZZ	45013951 	Lower Picker Finger	SF 1116
			<i>Priced per Picker Finger, sold in Bags of 2.</i>
NROLR1058FCZ3	45012885 	Lower Pressure Roller MICROSLEEVE™	SF 1116
SF-216HR	45012885 	Lower Pressure Roller MICROSLEEVE™	SF 1116
SF-216LH	45014025 	Lower Pressure Roller Kit Kit Contains: • (1) Lower Pressure Roller MICROSLEEVE™ • (2) Lower Picker Finger	SF 1116
NROLR1051FCZZ	45012886 	Manual Paper Feed Roller Tire Only	SF 1116
			<i>Priced per Tire, sold in Bags of 10.</i>
CROLP0921FC01	45017033 	Manual Pickup Roller	SF 1116
CROLP0921FC01	45011442 	Manual Pickup Roller Tire Only Ribbed Tire	SF 1116
			<i>Priced per Tire, sold in Bags of 10.</i>
NROLR1049FCZ1	45016482 	Paper Feed Roller	SF 1116



For use in
Sharp
Copiers

Central/Eastern Europe
Telephone: 31(0)183-696969
Fax: 31(0)183-629055
E-mail: order@edc.katun.com





OEM PN	KATUN PN	DESCRIPTION	MODEL NO.
Parts for use in Sharp SF 1116			
NROLR1049FCZ1	45012632 	Paper Feed Roller Tire Only	SF 1116 <i>Priced per Tire, sold in Bags of 10.</i>
NROLR0878FCZZ	45017032 	Paper Pickup Roller	SF 1116
NROLR0878FCZZ	45011076 	Paper Pickup Roller Tire Only	SF 1116 <i>Priced per Tire, sold in Bags of 10.</i>
CBRGP0528FC02	45014521 	Rear Fuser Roller Bushing	SF 1116 <i>Priced per Bushing, sold in Bags of 10.</i>
NBRGC0136FCZ1	45016755 	Sintered Bronze Bushing	SF 1116 <i>Priced per Bushing, sold in Packages of 10.</i>
NBRGC0136FCZZ	45016755 	Sintered Bronze Bushing	SF 1116 <i>Priced per Bushing, sold in Packages of 10.</i>
NROLT1063FCZ2	45013027 	Upper Fuser Roller DURACON™ II	SF 1116
SF-216HU	45013027 	Upper Fuser Roller DURACON™ II	SF 1116
NGERH1214FCZZ	45012819 	Upper Fuser Roller Gear	SF 1116
SF-216UH	45015481 	Upper Fuser Roller Kit Kit Contains: <ul style="list-style-type: none"> • (1) Upper Fuser Roller Gear • (2) Roller Stopper • (1) Upper Fuser Roller DURACON™ II • (4) Upper Picker Finger • (1) Front Fuser Roller Bushing • (1) Rear Fuser Roller Bushing 	SF 1116
PTME-0168FCZZ	45013096 	Upper Picker Finger	SF 1116 <i>Priced per Picker Finger, sold in Packages of 10.</i>
PRNGP0050FCZZ	45012311 	V Ring	SF 1116 <i>Priced per Bag, 4 Seals per Bag.</i>

OEM PN	KATUN PN	DESCRIPTION	MODEL NO.
--------	----------	-------------	-----------

Parts for use in Sharp SF 1120





SF-220LH	45015435 	Lower Pressure Roller Kit Kit Contains: • (1) Lower Pressure Roller MICROSLEEVE™ • (4) Lower Picker Finger	SF 1120
SF-216HU	45013027 	Upper Fuser Roller DURACON™ II	SF 1120
SF-216UH	45015481 	Upper Fuser Roller Kit Kit Contains: • (1) Upper Fuser Roller Gear • (2) Roller Stopper • (1) Upper Fuser Roller DURACON™ II • (4) Upper Picker Finger • (1) Front Fuser Roller Bushing • (1) Rear Fuser Roller Bushing	SF 1120

Parts for use in Sharp SF 2010

DWIR-0466CSZZ	45375548 	Corona Wire Spool 50 m / Spool 70μ Oxidized All Applications	SF 2010
RLMPU0360FCZZ	45021201 	Exposure Lamp 160V 250W	SF 2010
NROLP0648FCZZ	45013146 	Paper Feed Roller Tire Only	SF 2010
NROLT0799FCZZ	45636852 	Upper Fuser Roller DURACON™ II	SF 2010

*Priced per Tire,
sold in Bags of 10.*















Parts for use in Sharp SF 2014

DWIR-0466CSZZ	45375548 	Corona Wire Spool 50 m / Spool 70μ Oxidized All Applications	SF 2014
MSPRT0513FCZZ	45524654 	Corona Wire Spring Stainless Steel Various Applications	SF 2014
OKS-33K02130/	45012699 	Drum Cleaning Blade Assembly	SF 2014
RLMPU0537FCZZ	45014726 	Exposure Lamp 170V 280W	SF 2014

*Priced per Spring,
sold in Bags of 10.*

For use in
Sharp
Copiers













Central/Eastern Europe
Telephone: 31(0)183-696969
Fax: 31(0)183-629055
E-mail: order@edc.katun.com

OEM PN	KATUN PN	DESCRIPTION	MODEL NO.	
Parts for use in Sharp SF 2014				
CBRGP0525FC02	45014520 	Front Fuser Roller Bushing	SF 2014	<i>Priced per Bushing, sold in Bags of 10.</i>
SF-214HR	45015480 	Fuser Roller Kit Kit Contains: • (1) Lower Pressure Roller • (1) Upper Fuser Roller DURACON™ II • (4) Lower Picker Finger • (1) Upper Fuser Roller Gear • (2) Roller Stopper • (3) Upper Picker Finger • (1) Front Fuser Roller Bushing • (1) Rear Fuser Roller Bushing	SF 2014	
CROLN1026FC33	45012580 	Lower Fuser Cleaning Roller	SF 2014	
LPLTM4746FCZZ	45012562 	Lower Picker Finger	SF 2014	<i>Priced per Picker Finger, sold in Bags of 4.</i>
NROLI1028FCZZ	45012369 	Lower Pressure Roller	SF 2014	
NROLR1051FCZZ	45012886 	Manual Paper Feed Roller Tire Only	SF 2014	<i>Priced per Tire, sold in Bags of 10.</i>
CROLP0921FC01	45017033 	Manual Pickup Roller	SF 2014	
CROLP0921FC01	45011442 	Manual Pickup Roller Tire Only Ribbed Tire	SF 2014	<i>Priced per Tire, sold in Bags of 10.</i>
NROLR1049FCZ1	45016482 	Paper Feed Roller	SF 2014	
NROLR1049FCZ1	45012632 	Paper Feed Roller Tire Only	SF 2014	<i>Priced per Tire, sold in Bags of 10.</i>
NROLR0878FCZZ	45017032 	Paper Pickup Roller	SF 2014	
NROLR0878FCZZ	45011076 	Paper Pickup Roller Tire Only	SF 2014	<i>Priced per Tire, sold in Bags of 10.</i>
CBRGP0528FC02	45014521 	Rear Fuser Roller Bushing	SF 2014	<i>Priced per Bushing, sold in Bags of 10.</i>
CROLR1048FC32	45013175 	Reverse Roller Unit Tire Only	SF 2014	<i>Priced per Tire, sold in Bags of 10.</i>



Katun Performance Product

















© 2004 Katun Corporation

OEM PN	KATUN PN	DESCRIPTION	MODEL NO.	
Parts for use in Sharp SF 2014				
NBRGC0136FCZ1	45016755 	Sintered Bronze Bushing	SF 2014	<i>Priced per Bushing, sold in Packages of 10.</i>
NROLT1031FCZZ	45012480 	Upper Fuser Roller DURACON™ II	SF 2014	
NGERH0443FCZ1	45012819 	Upper Fuser Roller Gear	SF 2014	
PTME-0168FCZZ	45013096 	Upper Picker Finger	SF 2014	<i>Priced per Picker Finger, sold in Packages of 10.</i>
PRNGP0005GCZZ	45018026 	V Ring	SF 2014	<i>Priced per Seal, sold in Bags of 4.</i>
PRNGP0050FCZZ	45012311 	V Ring	SF 2014	<i>Priced per Bag, 4 Seals per Bag.</i>
Parts for use in Sharp SF 2018				
CCLEZ0117FC31	45010155 	Drum Cleaning Blade	SF 2018	
CCLEZ0117FC31	45022581	Drum Cleaning Blade Access By Katun	SF 2018	
Parts for use in Sharp SF 2020, SF 2120, SF 2220, SF 2320				
CPLTM4129FC01	45011991 	Charge Plate	SF 2020, SF 2120, SF 2220, SF 2320	
SF-216PU	45011991 	Charge Plate	SF 2020, SF 2120, SF 2220, SF 2320	
LPLTZ4069FCZZ	45013151 	Corona Screen Grid	SF 2020, SF 2120, SF 2220, SF 2320	
DWIR-0466CSZZ	45375548 	Corona Wire Spool 50 m / Spool 70µ Oxidized Transfer, Separation	SF 2020, SF 2120, SF 2220, SF 2320	
UCLEZ0108FCZ1	45000401 	Drum Cleaning Blade	SF 2020, SF 2120, SF 2220, SF 2320	
UCLEZ0108FCZ1	45022580	Drum Cleaning Blade Access By Katun	SF 2020, SF 2120, SF 2220, SF 2320	
PTME-0211FCZ1	45020110 	Drum Picker Finger	SF 2020, SF 2120, SF 2220, SF 2320	<i>Priced per Picker Finger, sold in Packages of 2.</i>
RLMPU0495FCZ1	45021123 	Exposure Lamp 170V 310W	SF 2020, SF 2120, SF 2220, SF 2320	



For use in
Sharp
Copiers











Central/Eastern Europe
Telephone: 31(0)183-696969
Fax: 31(0)183-629055
E-mail: order@edc.katun.com

OEM PN	KATUN PN	DESCRIPTION	MODEL NO.	
Parts for use in Sharp SF 2020, SF 2120, SF 2220, SF 2320				
CBRGP0525FC02	45014520 	Front Fuser Roller Bushing	SF 2020, SF 2120, SF 2220, SF 2320	<i>Priced per Bushing, sold in Bags of 10.</i>
RLMPU0551FCZZ	45021096 	Heater Lamp 220V 1000W	SF 2020, SF 2120	
PTME-0244FCZZ	45013951 	Lower Picker Finger	SF 2020, SF 2120, SF 2220, SF 2320	<i>Priced per Picker Finger, sold in Bags of 2.</i>
NROLR1058FCZ3	45012885 	Lower Pressure Roller MICROSLEEVE™	SF 2020, SF 2120, SF 2220, SF 2320	
SF-216HR	45012885 	Lower Pressure Roller MICROSLEEVE™	SF 2020, SF 2120, SF 2220, SF 2320	
SF-220LH	45015435 	Lower Pressure Roller Kit Kit Contains: • (1) Lower Pressure Roller MICROSLEEVE™ • (4) Lower Picker Finger	SF 2020, SF 2120, SF 2220, SF 2320	
NROLR0955FCZZ	45016477 	Manual Paper Feed Roller	SF 2120, SF 2220, SF 2320	
NROLR0955FCZZ	45012756 	Manual Paper Feed Roller Tire Only	SF 2120, SF 2220, SF 2320	<i>Priced per Tire, sold in Bags of 10.</i>
CROLP0921FC01	45017033 	Manual Pickup Roller	SF 2020, SF 2120, SF 2220, SF 2320	
CROLP0921FC01	45011442 	Manual Pickup Roller Tire Only Ribbed Tire	SF 2020, SF 2120, SF 2220, SF 2320	<i>Priced per Tire, sold in Bags of 10.</i>
NROLR0964FCZZ	45017031 	Manual Reverse Roller Duplex	SF 2120, SF 2320	
NROLR0964FCZZ	45013017 	Manual Reverse Roller Tire Only Duplex	SF 2120, SF 2320	<i>Priced per Tire, sold in Bags of 10.</i>
NROLR1049FCZ1	45016482 	Paper Feed Roller	SF 2020, SF 2120	
NROLR1049FCZ1	45012632 	Paper Feed Roller Tire Only	SF 2020, SF 2120	<i>Priced per Tire, sold in Bags of 10.</i>
NROLR0878FCZZ	45017032 	Paper Pickup Roller	SF 2020, SF 2220, SF 2320	
NROLR0878FCZZ	45011076 	Paper Pickup Roller Tire Only	SF 2020, SF 2220, SF 2320	<i>Priced per Tire, sold in Bags of 10.</i>















Katun Performance Product

© 2004 Katun Corporation

OEM PN	KATUN PN	DESCRIPTION	MODEL NO.	
Parts for use in Sharp SF 2020, SF 2120, SF 2220, SF 2320				
CBRGP0528FC02	45014521 	Rear Fuser Roller Bushing	SF 2020, SF 2120, SF 2220, SF 2320	<i>Priced per Bushing, sold in Bags of 10.</i>
NBRGC0136FCZ1	45016755 	Sintered Bronze Bushing	SF 2020, SF 2120, SF 2220, SF 2320	<i>Priced per Bushing, sold in Packages of 10.</i>
NBRGC0136FCZZ	45016755 	Sintered Bronze Bushing	SF 2020, SF 2120, SF 2220, SF 2320	<i>Priced per Bushing, sold in Packages of 10.</i>
NROLT1063FCZZ	45013027 	Upper Fuser Roller DURACON™ II	SF 2020, SF 2120, SF 2220, SF 2320	
SF-216HU	45013027 	Upper Fuser Roller DURACON™ II	SF 2020, SF 2120, SF 2220, SF 2320	
NGERH0443FCZ1	45012819 	Upper Fuser Roller Gear	SF 2020, SF 2120, SF 2220, SF 2320	
SF-216UH	45015481 	Upper Fuser Roller Kit Kit Contains: <ul style="list-style-type: none"> • (1) Upper Fuser Roller Gear • (2) Roller Stopper • (1) Upper Fuser Roller DURACON™ II • (4) Upper Picker Finger • (1) Front Fuser Roller Bushing • (1) Rear Fuser Roller Bushing 	SF 2020, SF 2120, SF 2220, SF 2320	
PTME-0168FCZZ	45013096 	Upper Picker Finger	SF 2020, SF 2120, SF 2220, SF 2320	<i>Priced per Picker Finger, sold in Packages of 10.</i>
PRNGP0050FCZZ	45012311 	V Ring	SF 2020, SF 2120, SF 2220, SF 2320	<i>Priced per Bag, 4 Seals per Bag.</i>
Parts for use in Sharp SF 2025, SF 2030, SF 2040				
SF-330KB	45014529 	160K Maintenance Kit Kit Contains: <ul style="list-style-type: none"> • (1) Toner Holding Cleaner Unit • (1) Upper Fuser Roller Gear • (1) Lower Pressure Roller • (1) Upper Fuser Roller • (1) Developer Unit Seal 	SF 2025, SF 2030	
A3SF240KB	45014530 	160K Maintenance Kit Kit Contains: <ul style="list-style-type: none"> • (1) Toner Holding Cleaner Unit • (1) Upper Fuser Roller Gear • (1) Lower Pressure Roller • (1) Upper Fuser Roller • (1) Developer Unit Seal 	SF 2040	













For use in
Sharp
Copiers

Central/Eastern Europe
Telephone: 31(0)183-696969
Fax: 31(0)183-629055
E-mail: order@edc.katun.com

OEM PN	KATUN PN	DESCRIPTION	MODEL NO.
Parts for use in Sharp SF 2025, SF 2030, SF 2040			
SF-340KB	45014530 	160K Maintenance Kit Kit Contains: • (1) Toner Holding Cleaner Unit • (1) Upper Fuser Roller Gear • (1) Lower Pressure Roller • (1) Upper Fuser Roller • (1) Developer Unit Seal	SF 2040
SF-240KA	45014407 	80K Maintenance Kit Kit Contains: • (1) Charge Plate • (2) Drum Picker Finger • (2) Lower Picker Finger • (4) Upper Picker Finger • (1) Upper Fuser Cleaning Roller Assembly • (1) Drum Cleaning Blade • (1) Lower Fuser Cleaning Roller • (4) Waste Toner Bottle • (1) Corona Screen Grid	SF 2025, SF 2030, SF 2040
NBRGY0466FCZZ	45576233 	Bearing Various Applications	SF 2025, SF 2030, SF 2040
CPLTM4129FC01	45011991 	Charge Plate	SF 2025, SF 2030, SF 2040
SF-216PU	45011991 	Charge Plate	SF 2025, SF 2030, SF 2040
LPLTZ5007FCZZ	45013153 	Corona Screen Grid	SF 2025, SF 2030, SF 2040
DWIR-0466CSZZ	45375548 	Corona Wire Spool 50 m / Spool 70µ Oxidized Transfer, Separation	SF 2025, SF 2030, SF 2040
MSPRT0513FCZZ	45524654 	Corona Wire Spring Stainless Steel Various Applications	SF 2025, SF 2030, SF 2040
UCLEZ0136FCZZ	45014743 	Developer Unit Seal	SF 2025, SF 2030, SF 2040
CCLEZ0117FC31	45010155 	Drum Cleaning Blade	SF 2025, SF 2030, SF 2040
CCLEZ0117FC31	45022581	Drum Cleaning Blade Access By Katun	SF 2025, SF 2030, SF 2040
SF-222BL	45010155 	Drum Cleaning Blade	SF 2025, SF 2030, SF 2040
CDAIU0451FC51	45020110 	Drum Picker Finger Assembly	SF 2025, SF 2030, SF 2040

*Priced per Spring,
sold in Bags of 10.*

*Priced per Picker Finger,
sold in Packages of 2.*

OEM PN	KATUN PN	DESCRIPTION	MODEL NO.
Parts for use in Sharp SF 2025, SF 2030, SF 2040			
RLMPU0495FCZ1	45021123 	Exposure Lamp 170V 310W	SF 2025, SF 2030, SF 2040
N/P/N	45019752 	Feed Roller Replacement Kit New Style Kit Contains: • (1) Paper Feed Roller • (1) Paper Pickup Roller • (1) Reverse Roller	SF 2030, SF 2040
N/P/N	45014639 	Feed Tire Replacement Kit Tire Only Old Style Kit Contains: • (1) Paper Pickup Tire • (1) Paper Feed Tire • (1) Separation Tire	SF 2025, SF 2030, SF 2040
LBSHZ0330FCZZ	45012446 	Heat Insulating Sleeve	SF 2025, SF 2030, SF 2040
RLMPU0574FCZZ	45021102 	Heater Lamp 220V 900W	SF 2025, SF 2030
RLMPU0516FCZZ	45021090 	Heater Lamp 220V 1200W	SF 2040
CROLN0912FC31	45021394 	Lower Fuser Cleaning Roller	SF 2025, SF 2030, SF 2040
SF-235RL	45021394 	Lower Fuser Cleaning Roller	SF 2025, SF 2030, SF 2040
NBRGY0296FCZZ	45013093 	Lower Fuser Roller Bearing	SF 2025, SF 2030, SF 2040
PTME-0174FCZ1	45018041 	Lower Picker Finger	SF 2025, SF 2030, SF 2040
NROLI1103FCZZ	45013214 	Lower Pressure Roller MICROSLEEVE™	SF 2025, SF 2030, SF 2040
SF-240LH	45014024 	Lower Pressure Roller Kit Kit Contains: • (1) Lower Pressure Roller MICROSLEEVE™ • (2) Lower Picker Finger	SF 2025, SF 2030, SF 2040
NROLR1051FCZZ	45012886 	Manual Paper Feed Roller Tire Only	SF 2025, SF 2030, SF 2040

















*Priced per Heat Sleeve,
 sold in Bags of 10.*

*Priced per Picker Finger,
 sold in Boxes of 10.*

*Priced per Tire,
 sold in Bags of 10.*









For use in
Sharp
Copiers

Central/Eastern Europe
Telephone: 31(0)183-696969
Fax: 31(0)183-629055
E-mail: order@edc.katun.com

OEM PN	KATUN PN	DESCRIPTION	MODEL NO.	
Parts for use in Sharp SF 2025, SF 2030, SF 2040				
CGUMM0288FC31	45014266 	Manual Paper Pickup Tire Tire Only	SF 2025, SF 2030, SF 2040	<i>Priced per Tire, sold in Bags of 10.</i>
CROLP1115FC01	45014266 	Manual Pickup Roller Tire Only	SF 2025, SF 2030, SF 2040	<i>Priced per Tire, sold in Bags of 10.</i>
CSFTZ2233FC31	45013175 	Manual Reverse Roller Assembly Tire Only	SF 2025, SF 2030, SF 2040	<i>Priced per Tire, sold in Bags of 10.</i>
NROLR1049FCZZ	45016482 	Paper Feed Roller	SF 2025, SF 2030, SF 2040	
NROLR1049FCZZ	45012632 	Paper Feed Roller Tire Only	SF 2025, SF 2030, SF 2040	<i>Priced per Tire, sold in Bags of 10.</i>
NROLR1218FCZZ	45018450 	Paper Feed Roller	SF 2025, SF 2030, SF 2040	
NROLR1114FCZZ	45014266 	Paper Pickup Roller Tire Only	SF 2025, SF 2030, SF 2040	<i>Priced per Tire, sold in Bags of 10.</i>
NROLR1219FCZZ	45018451 	Paper Pickup Roller	SF 2025, SF 2030, SF 2040	
NROLR1219FCZZ	45021458 	Paper Pickup Roller Tire Only	SF 2025, SF 2030, SF 2040	<i>Priced per Tire, sold in Bags of 10.</i>
NROLR1093FCZZ	45017034 	Reverse Roller	SF 2025, SF 2030, SF 2040	
NROLR1093FCZZ	45011352 	Reverse Roller Tire Only	SF 2025, SF 2030, SF 2040	<i>Priced per Tire, sold in Bags of 10.</i>
NROLR1229FCZZ	45018452 	Reverse Roller	SF 2025, SF 2030, SF 2040	
NBRGC0140FCZZ	45016756 	Sintered Bronze Bushing	SF 2025, SF 2030, SF 2040	<i>Priced per Bushing, sold in Packages of 10.</i>
UCLEZ0126FCZ1	45012723 	Toner Holder Seal	SF 2025, SF 2030, SF 2040	
SF-240RU	45016856 	Upper Fuser Cleaning Roller	SF 2025, SF 2030, SF 2040	
CROLN0935FC33	45016856 	Upper Fuser Cleaning Roller Assembly	SF 2025, SF 2030, SF 2040	
NROLT1102FCZ1	45014437 	Upper Fuser Roller ALUMANA™ Patented TEFLON® coating with reinforcing oxides extends life.	SF 2025, SF 2030	

OEM PN	KATUN PN	DESCRIPTION	MODEL NO.
--------	----------	-------------	-----------

Parts for use in Sharp SF 2025, SF 2030, SF 2040

NROLT1102FCZ1	45014840	Upper Fuser Roller Access By Katun	SF 2025, SF 2030
NROLT0913FCZ1	45014437 	Upper Fuser Roller ALUMANA™ Patented TEFLON® coating with reinforcing oxides extends life.	SF 2040
NROLT0913FCZ1	45014840	Upper Fuser Roller Access By Katun	SF 2040
NBRGY0295FCZZ	45576217 	Upper Fuser Roller Bearing	SF 2025, SF 2030, SF 2040
NGERH0475FCZ1	45012825 	Upper Fuser Roller Gear	SF 2025, SF 2030, SF 2040
SF-330UH	45013612 	Upper Fuser Roller Kit Kit Contains: <ul style="list-style-type: none"> • (1) Upper Fuser Roller ALUMANA™ • (1) Upper Fuser Roller Gear • (4) Upper Picker Finger 	SF 2025, SF 2030, SF 2040
SF-340UH	45013612 	Upper Fuser Roller Kit Kit Contains: <ul style="list-style-type: none"> • (1) Upper Fuser Roller ALUMANA™ • (1) Upper Fuser Roller Gear • (4) Upper Picker Finger 	SF 2025, SF 2030, SF 2040
PTME-0168FCZZ	45013096 	Upper Picker Finger	SF 2025, SF 2030, SF 2040
PRNGP0050FCZZ	45012311 	V Ring	SF 2025, SF 2030, SF 2040
CYOK-0039FC01	45014388 	Waste Toner Bottle	SF 2025, SF 2030, SF 2040

Priced per Picker Finger, sold in Packages of 10.











Priced per Bag, 4 Seals per Bag.

Parts for use in Sharp SF 2035

SF-235KB	45016194 	160K Maintenance Kit Kit Contains: <ul style="list-style-type: none"> • (1) Toner Holding Cleaner Unit • (1) Upper Fuser Roller Gear • (1) Developer Unit Seal • (1) Upper Fuser Roller ALUMANA™ • (1) Lower Pressure Roller 	SF 2035
----------	---	--	---------

For use in
Sharp
Copiers

Central/Eastern Europe
Telephone: 31(0)183-696969
Fax: 31(0)183-629055
E-mail: order@edc.katun.com

OEM PN	KATUN PN	DESCRIPTION	MODEL NO.
Parts for use in Sharp SF 2035			
SF-235KA	45014404 	80K Maintenance Kit Kit Contains: <ul style="list-style-type: none"> • (2) Drum Picker Finger • (1) Upper Fuser Cleaning Roller • (1) Lower Fuser Cleaning Roller • (1) Drum Cleaning Blade • (4) Upper Picker Finger • (2) Lower Picker Finger • (1) Charge Plate • (4) Waste Toner Bottle • (1) Corona Screen Grid 	SF 2035
CPLTM4129FC01	45011991 	Charge Plate	SF 2035
SF-216PU	45011991 	Charge Plate	SF 2035
LPLTZ4069FCZZ	45013151 	Corona Screen Grid	SF 2035
DWIR-0466CSZZ	45375548 	Corona Wire Spool 50 m / Spool 70µ Oxidized Transfer, Separation	SF 2035
MSPRT0513FCZZ	45524654 	Corona Wire Spring Stainless Steel Various Applications	SF 2035
CCLEZ0117FC31	45010155 	Drum Cleaning Blade	SF 2035
CCLEZ0117FC31	45022581	Drum Cleaning Blade Access By Katun	SF 2035
SF-222BL	45010155 	Drum Cleaning Blade	SF 2035
CDAIU0451FC51	45020110 	Drum Picker Finger Assembly	SF 2035
RLMPU0495FCZZ	45021123 	Exposure Lamp 170V 310W	SF 2035
N/P/N	45019752 	Feed Roller Replacement Kit New Style Kit Contains: <ul style="list-style-type: none"> • (1) Paper Feed Roller • (1) Paper Pickup Roller • (1) Reverse Roller 	SF 2035

*Priced per Spring,
sold in Bags of 10.*

*Priced per Picker Finger,
sold in Packages of 2.*











OEM PN	KATUN PN	DESCRIPTION	MODEL NO.
--------	----------	-------------	-----------

Parts for use in Sharp SF 2035

N/P/N	45012325 	Feed Tire Replacement Kit Tire Only Old Style Kit Contains: • (1) Manual Pickup Tire • (2) Separation/Feed Tire	SF 2035	
LBSHC0228FCZZ	45012446 	Heat Insulating Sleeve	SF 2035	<i>Priced per Heat Sleeve, sold in Bags of 10.</i>
RLMPU0516FCZZ	45021090 	Heater Lamp 220V 1200W	SF 2035	
CROLN0912FC31	45021394 	Lower Fuser Cleaning Roller	SF 2035	
SF-235RL	45021394 	Lower Fuser Cleaning Roller	SF 2035	
NBRGY0296FCZZ	45013093 	Lower Fuser Roller Bearing	SF 2035	
PTME-0174FCZ1	45018041 	Lower Picker Finger	SF 2035	<i>Priced per Picker Finger, sold in Boxes of 10.</i>
NROLI0963FCZZ	45013214 	Lower Pressure Roller MICROSLEEVE™	SF 2035	
NROLI0963FCZZ	45636769 	Lower Pressure Roller	SF 2035	
SF-235LH	45014024 	Lower Pressure Roller Kit Kit Contains: • (1) Lower Pressure Roller MICROSLEEVE™ • (2) Lower Picker Finger	SF 2035	
NROLR0922FCZZ	45016478 	Manual Paper Feed Roller	SF 2035	
CGUMM0286FC31	45009690 	Manual Paper Feed Tire Tire Only	SF 2035	<i>Priced per Tire, sold in Bags of 10.</i>
CROLP0921FC01	45017033 	Manual Pickup Roller	SF 2035	
CROLP0921FC01	45011442 	Manual Pickup Roller Tire Only Ribbed Tire	SF 2035	<i>Priced per Tire, sold in Bags of 10.</i>
CSFTZ1771FC31	45011357 	Manual Reverse Roller Assembly Tire Only	SF 2035	<i>Priced per Tire, sold in Bags of 10.</i>

For use in
Sharp
Copiers











Central/Eastern Europe
Telephone: 31(0)183-696969
Fax: 31(0)183-629055
E-mail: order@edc.katun.com

OEM PN	KATUN PN	DESCRIPTION	MODEL NO.
Parts for use in Sharp SF 2035			
NROLR0901FCZZ	45016481 	Paper Feed Roller	SF 2035
NROLR0901FCZZ	45011352 	Paper Feed Roller Tire Only	SF 2035 <i>Priced per Tire, sold in Bags of 10.</i>
NROLR0986FCZZ	45020763 	Paper Feed Roller Tire Only For duplex unit only	SF 2035 <i>Priced per Tire, sold in Bags of 10.</i>
NROLR0986FCZZ	45011352 	Paper Feed Roller Tire Only	SF 2035 <i>Priced per Tire, sold in Bags of 10.</i>
NROLR1049FCZZ	45016482 	Paper Feed Roller	SF 2035
NROLR1049FCZZ	45012632 	Paper Feed Roller Tire Only	SF 2035 <i>Priced per Tire, sold in Bags of 10.</i>
NROLR1218FCZZ	45018450 	Paper Feed Roller	SF 2035
NROLR0920FCZZ	45016480 	Paper Pickup Roller	SF 2035
NROLR0920FCZZ	45011442 	Paper Pickup Roller Tire Only Ribbed Tire	SF 2035 <i>Priced per Tire, sold in Bags of 10.</i>
NROLR1219FCZZ	45018451 	Paper Pickup Roller	SF 2035
NROLR1219FCZZ	45021458 	Paper Pickup Roller Tire Only	SF 2035 <i>Priced per Tire, sold in Bags of 10.</i>
NROLR1229FCZZ	45018452 	Reverse Roller	SF 2035
NROLR0902FCZZ	45016479 	Separation Roller	SF 2035
NROLR0902FCZZ	45011352 	Separation Roller Tire Only	SF 2035 <i>Priced per Tire, sold in Bags of 10.</i>
NBRGC0136FCZZ	45016755 	Sintered Bronze Bushing	SF 2035 <i>Priced per Bushing, sold in Packages of 10.</i>
NBRGC0140FCZZ	45016756 	Sintered Bronze Bushing	SF 2035 <i>Priced per Bushing, sold in Packages of 10.</i>
CCLEZ0126FC31	45012723 	Toner Holding Cleaner Unit	SF 2035



Katun Performance Product

© 2004 Katun Corporation

OEM PN	KATUN PN	DESCRIPTION	MODEL NO.
Parts for use in Sharp SF 2035			
CROLN0586FC33	45016811 	Upper Fuser Cleaning Roller	SF 2035
SF-235RU	45016811 	Upper Fuser Cleaning Roller	SF 2035
NROLT0962FCZZ	45014523 	Upper Fuser Roller ALUMANA™ Patented TEFLON® coating with reinforcing oxides extends life.	SF 2035
NBRGY0295FCZZ	45576217 	Upper Fuser Roller Bearing	SF 2035
N/P/N	45012816 	Upper Fuser Roller Bearing Kit Kit Contains: <ul style="list-style-type: none"> • (2) Heat Insulating Sleeve • (2) Upper Fuser Roller Bearing Kit 	SF 2035
NGERH0475FCZ1	45012825 	Upper Fuser Roller Gear	SF 2035
SF-235UH	45013613 	Upper Fuser Roller Kit Kit Contains: <ul style="list-style-type: none"> • (1) Upper Fuser Roller ALUMANA™ • (1) Upper Fuser Roller Gear • (4) Upper Picker Finger 	SF 2035
PTME-0168FCZZ	45013096 	Upper Picker Finger	SF 2035
PRNGP0013FCZZ	45011640 	V Ring	SF 2035
PRNGP0050FCZZ	45012311 	V Ring	SF 2035
CYOK-0039FC01	45014388 	Waste Toner Bottle	SF 2035

Priced per Picker Finger, sold in Packages of 10.

Priced per Seal, sold in Bags of 4.













Priced per Bag, 4 Seals per Bag.













Parts for use in Sharp SF 2050, SF 2052

SF-250KA	45014405 	100K Maintenance Kit Kit Contains: <ul style="list-style-type: none"> • (1) Upper Fuser Cleaning Roller Assembly • (1) Lower Fuser Cleaning Roller • (1) Drum Cleaning Blade • (1) Waste Toner Bottle 	SF 2050, SF 2052
----------	---	--	------------------

For use in
Sharp
Copiers

Central/Eastern Europe
Telephone: 31(0)183-696969
Fax: 31(0)183-629055
E-mail: order@edc.katun.com

OEM PN	KATUN PN	DESCRIPTION	MODEL NO.
Parts for use in Sharp SF 2050, SF 2052			
SF-250KB	45013619 	200K Maintenance Kit Kit Contains: <ul style="list-style-type: none"> • (1) Charge Plate • (1) Developer Unit Front Side Seal • (1) Cleaning Unit Front Side Seal • (1) Cleaning Unit Rear Side Seal • (1) Developer Unit Rear Side Seal • (2) Drum Picker Finger • (1) Toner Holder Seal • (1) Corona Screen Grid 	SF 2050, SF 2052
0CW2160P344//	45576233 	Bearing	SF 2052
NBRGY0131FCZZ	45576204 	Bearing Various Applications	SF 2050, SF 2052
NBRGY0466FCZZ	45576233 	Bearing Various Applications	SF 2052
CPLTM4129FC01	45011991 	Charge Plate	SF 2050, SF 2052
SF-216PU	45011991 	Charge Plate	SF 2050, SF 2052
LPLTZ4876FCZZ	45013154 	Corona Screen Grid	SF 2050, SF 2052
DWIR-0466CSZZ	45375548 	Corona Wire Spool 50 m / Spool 70µ Oxidized Transfer, Separation	SF 2050, SF 2052
MSPRT0513FCZZ	45524654 	Corona Wire Spring Stainless Steel Various Applications	SF 2050, SF 2052 <i>Priced per Spring, sold in Bags of 10.</i>
CCLEZ0125FC31	45011438 	Drum Cleaning Blade	SF 2050, SF 2052
SD-360CB	45012610 	Drum Cleaning Blade	SF 2050, SF 2052 <i>Priced per Kit, 10 Blades per Kit.</i>
PTME-0227FCZZ	45013791 	Drum Picker Finger	SF 2050, SF 2052 <i>Priced per Picker Finger, sold in Bags of 2.</i>
NROLR1088FCZZ	45013476 	Duplex Paper Feed Roller Tire Only	SF 2050, SF 2052 <i>Priced per Tire, sold in Bags of 10.</i>

OEM PN	KATUN PN	DESCRIPTION	MODEL NO.
Parts for use in Sharp SF 2050, SF 2052			
N/P/N	45015621 	Feed Tire Replacement Kit Tire Only Kit Contains: • (1) Paper Pickup Tire • (1) Paper Feed Tire • (1) Separation Tire	SF 2050
LBSHZ0330FCZZ	45012446 	Heat Insulating Sleeve	SF 2050
			<i>Priced per Heat Sleeve, sold in Bags of 10.</i>
LBSHZ0343FCZZ	45012446 	Heat Insulating Sleeve	SF 2052
			<i>Priced per Heat Sleeve, sold in Bags of 10.</i>
SF-250RL	45013063 	Lower Fuser Cleaning Roller	SF 2050
CROLN1106FC31	45013063 	Lower Fuser Cleaning Roller	SF 2050, SF 2052
PTME-0174FCZ1	45018041 	Lower Picker Finger	SF 2050, SF 2052
			<i>Priced per Picker Finger, sold in Boxes of 10.</i>
NROLI1075FCZZ	45020950 	Lower Pressure Roller MICROSLEEVE™ 70µ PFA Sleeve	SF 2050, SF 2052
SF-250LH	45014330 	Lower Pressure Roller Kit MICROSLEEVE™ PFA Sleeve extends life. Kit Contains: • (1) Lower Pressure Roller • (4) Lower Picker Finger	SF 2050, SF 2052
NROLR1051FCZZ	45012886 	Manual Paper Feed Roller Tire Only	SF 2050
			<i>Priced per Tire, sold in Bags of 10.</i>
NROLR0955FCZZ	45016477 	Manual Paper Feed Roller	SF 2052
NROLR0955FCZZ	45012756 	Manual Paper Feed Roller Tire Only	SF 2052
			<i>Priced per Tire, sold in Bags of 10.</i>
CROLP0921FC01	45017033 	Manual Pickup Roller	SF 2050
CROLP0921FC01	45011442 	Manual Pickup Roller Tire Only Ribbed Tire	SF 2050
			<i>Priced per Tire, sold in Bags of 10.</i>

For use in
Sharp
Copiers















Central/Eastern Europe
Telephone: 31(0)183-696969
Fax: 31(0)183-629055
E-mail: order@edc.katun.com

OEM PN	KATUN PN	DESCRIPTION	MODEL NO.
Parts for use in Sharp SF 2050, SF 2052			
NROLR0964FCZZ	45017031 	Manual Reverse Roller Various Applications Duplex	SF 2052 SF 2050
NROLR0964FCZZ	45013017 	Manual Reverse Roller Tire Only Various Applications Duplex	SF 2052 SF 2050
			<i>Priced per Tire, sold in Bags of 10.</i>
0CW2214P353//	45019289 	Original Document Feed Belt	SF 2052
0CW2214P339//	45014070 	Original Feed Roller Tire Only	SF 2052
			<i>Priced per Tire, sold in Bags of 4.</i>
0CW2214P471//	45019943 	Original Pickup Roller Ribbed Tire For Document Feeder	SF 2052
			<i>Priced per Pickup Roller, sold in Bags of 10.</i>
NROLR1049FCZZ	45016482 	Paper Feed Roller	SF 2050, SF 2052
NROLR1049FCZZ	45012632 	Paper Feed Roller Tire Only	SF 2050, SF 2052
			<i>Priced per Tire, sold in Bags of 10.</i>
NROLR0920FCZZ	45016480 	Paper Pickup Roller	SF 2050
NROLR0920FCZZ	45011442 	Paper Pickup Roller Tire Only Ribbed Tire	SF 2050
			<i>Priced per Tire, sold in Bags of 10.</i>
NROLR0956FCZZ	45017035 	Paper Pickup Roller Duplex	SF 2050, SF 2052
NROLR0956FCZZ	45012782 	Paper Pickup Roller Tire Only Duplex	SF 2050, SF 2052
			<i>Priced per Tire, sold in Bags of 10.</i>
NROLR1114FCZZ	45014266 	Paper Pickup Roller Tire Only	SF 2052
			<i>Priced per Tire, sold in Bags of 10.</i>
NROLR1093FCZZ	45017034 	Reverse Roller	SF 2050, SF 2052
NROLR1093FCZZ	45011352 	Reverse Roller Tire Only	SF 2050, SF 2052
			<i>Priced per Tire, sold in Bags of 10.</i>
CROLR1094FC32	45013175 	Reverse Roller Unit Tire Only	SF 2050
			<i>Priced per Tire, sold in Bags of 10.</i>
SF-250RU	45013290 	Upper Fuser Cleaning Roller Assembly	SF 2050















Katun Performance Product

© 2004 Katun Corporation

OEM PN	KATUN PN	DESCRIPTION	MODEL NO.	
Parts for use in Sharp SF 2050, SF 2052				
CROLN1076FC32	45013290 	Upper Fuser Cleaning Roller Assembly	SF 2052	
SF-252UR	45013984 	Upper Fuser Cleaning Roller Assembly Kit Contains: • (10) Upper Fuser Cleaning Roller Assembly	SF 2050, SF 2052	<i>Priced per Box, 10 Cleaning Rollers per Box.</i>
NROLT1074FCZ1	45014112 	Upper Fuser Roller ALUMANA™	SF 2050	
NROLT1074FCZ2	45014112 	Upper Fuser Roller ALUMANA™	SF 2050, SF 2052	
SF-252HU	45014112 	Upper Fuser Roller ALUMANA™	SF 2052	
NBRGY0295FCZZ	45576217 	Upper Fuser Roller Bearing	SF 2050	
NBRGY0551FCZZ	45576217 	Upper Fuser Roller Bearing	SF 2052	
N/P/N	45012816 	Upper Fuser Roller Bearing Kit Kit Contains: • (2) Heat Insulating Sleeve • (2) Upper Fuser Roller Bearing Kit	SF 2050	
NGERH0475FCZ1	45012825 	Upper Fuser Roller Gear	SF 2050, SF 2052	
SF-250UH	45014196 	Upper Fuser Roller Kit Kit Contains: • (1) Upper Fuser Roller ALUMANA™ • (4) Upper Picker Finger • (1) Upper Fuser Roller Gear	SF 2050	
SF-252UH	45016397 	Upper Fuser Roller Kit Kit Contains: • (1) Upper Fuser Roller ALUMANA™ • (2) Heat Insulating Sleeve • (1) Upper Fuser Roller Gear • (4) Upper Picker Finger	SF 2050, SF 2052	
PTME-0226FCZZ	45012403 	Upper Picker Finger	SF 2050, SF 2052	<i>Priced per Picker Finger, sold in Packages of 4.</i>
PRNGP0005GCZZ	45018026 	V Ring	SF 2050	<i>Priced per Seal, sold in Bags of 4.</i>
PRNGP0013FCZZ	45011640 	V Ring	SF 2050, SF 2052	<i>Priced per Seal, sold in Bags of 4.</i>

For use in
Sharp
Copiers

Central/Eastern Europe
Telephone: 31(0)183-696969
Fax: 31(0)183-629055
E-mail: order@edc.katun.com

OEM PN	KATUN PN	DESCRIPTION	MODEL NO.
Parts for use in Sharp SF 2050, SF 2052			
PRNGP0097FCZZ	45011640 	V Ring	SF 2052
			<i>Priced per Seal, sold in Bags of 4.</i>
CYOK-0049FC01	45014433 	Waste Toner Bottle	SF 2050, SF 2052
Parts for use in Sharp SF 2114, SF 2214			
DWIR-0466CSZZ	45375548 	Corona Wire Spool 50 m / Spool 70µ Oxidized All Applications	SF 2114, SF 2214
MSPRT0513FCZZ	45524654 	Corona Wire Spring Stainless Steel Various Applications	SF 2114, SF 2214
			<i>Priced per Spring, sold in Bags of 10.</i>
OKS-33K02130/	45012699 	Drum Cleaning Blade Assembly	SF 2114, SF 2214
RLMPU0537FCZZ	45014726 	Exposure Lamp 170V 280W	SF 2114, SF 2214
CBRGP0525FC02	45014520 	Front Fuser Roller Bushing	SF 2114, SF 2214
			<i>Priced per Bushing, sold in Bags of 10.</i>
SF-214HR	45015480 	Fuser Roller Kit Kit Contains: <ul style="list-style-type: none"> • (1) Lower Pressure Roller • (1) Upper Fuser Roller DURACON™ II • (4) Lower Picker Finger • (1) Upper Fuser Roller Gear • (2) Roller Stopper • (3) Upper Picker Finger • (1) Front Fuser Roller Bushing • (1) Rear Fuser Roller Bushing 	SF 2114, SF 2214
CROLN1026FC33	45012580 	Lower Fuser Cleaning Roller	SF 2114, SF 2214
LPLTM4746FCZZ	45012562 	Lower Picker Finger	SF 2114, SF 2214
			<i>Priced per Picker Finger, sold in Bags of 4.</i>
NROLI1028FCZZ	45012369 	Lower Pressure Roller	SF 2114, SF 2214
NROLR0922FCZZ	45016478 	Manual Paper Feed Roller	SF 2214
NROLR1051FCZZ	45012886 	Manual Paper Feed Roller Tire Only	SF 2114, SF 2214
			<i>Priced per Tire, sold in Bags of 10.</i>



Katun Performance Product

© 2004 Katun Corporation

26 October 2004

For the most current product and pricing information, visit the Katun On-Line Catalog at www.katun.com.

Prices, terms and conditions are subject to change without notice.

OEM PN	KATUN PN	DESCRIPTION	MODEL NO.	
Parts for use in Sharp SF 2114, SF 2214				
CGUMM0286FC31	45009690 	Manual Paper Feed Tire Tire Only	SF 2214	<i>Priced per Tire, sold in Bags of 10.</i>
CROLP0921FC01	45017033 	Manual Pickup Roller	SF 2114, SF 2214	
CROLP0921FC01	45011442 	Manual Pickup Roller Tire Only Ribbed Tire	SF 2114, SF 2214	<i>Priced per Tire, sold in Bags of 10.</i>
NROLR1049FCZ1	45016482 	Paper Feed Roller	SF 2114, SF 2214	
NROLR1049FCZ1	45012632 	Paper Feed Roller Tire Only	SF 2114, SF 2214	<i>Priced per Tire, sold in Bags of 10.</i>
NROLR0878FCZZ	45017032 	Paper Pickup Roller	SF 2114, SF 2214	
NROLR0878FCZZ	45011076 	Paper Pickup Roller Tire Only	SF 2114, SF 2214	<i>Priced per Tire, sold in Bags of 10.</i>
CBRGP0528FC02	45014521 	Rear Fuser Roller Bushing	SF 2114, SF 2214	<i>Priced per Bushing, sold in Bags of 10.</i>
CROLR1048FC32	45013175 	Reverse Roller Unit Tire Only	SF 2114, SF 2214	<i>Priced per Tire, sold in Bags of 10.</i>
NBRGC0136FCZ1	45016755 	Sintered Bronze Bushing	SF 2114, SF 2214	<i>Priced per Bushing, sold in Packages of 10.</i>
NROLT1031FCZZ	45012480 	Upper Fuser Roller DURACON™ II	SF 2114, SF 2214	
NGERH0443FCZ1	45012819 	Upper Fuser Roller Gear	SF 2114, SF 2214	
PTME-0168FCZZ	45013096 	Upper Picker Finger	SF 2114, SF 2214	<i>Priced per Picker Finger, sold in Packages of 10.</i>
PRNGP0005GCZZ	45018026 	V Ring	SF 2114, SF 2214	<i>Priced per Seal, sold in Bags of 4.</i>
PRNGP0050FCZZ	45012311 	V Ring	SF 2114, SF 2214	<i>Priced per Bag, 4 Seals per Bag.</i>

For use in
Sharp
Copiers

Central/Eastern Europe
Telephone: 31(0)183-696969
Fax: 31(0)183-629055
E-mail: order@edc.katun.com

OEM PN	KATUN PN	DESCRIPTION	MODEL NO.
Parts for use in Sharp SF 2216			
CPLTM4129FC01	45011991	Charge Plate	SF 2216
SF-216PU	45011991	Charge Plate	SF 2216
LPLTZ4069FCZZ	45013151	Corona Screen Grid	SF 2216
LPLTZ5474FCZZ	45013151	Corona Screen Grid	SF 2216
DWIR-0466CSZZ	45375548	Corona Wire Spool 50 m / Spool 70µ Oxidized Transfer, Separation	SF 2216
UCLEZ0108FCZ1	45000401	Drum Cleaning Blade	SF 2216
UCLEZ0108FCZ1	45022580	Drum Cleaning Blade Access By Katun	SF 2216
PTME-0211FCZ1	45020110	Drum Picker Finger	SF 2216
RLMPU0495FCZ1	45021123	Exposure Lamp 170V 310W	SF 2216
CBRGP0525FC02	45014520	Front Fuser Roller Bushing	SF 2216
RLMPU0551FCZZ	45021096	Heater Lamp 220V 1000W	SF 2216
PTME-0244FCZZ	45013951	Lower Picker Finger	SF 2216
NROLR1058FCZ3	45012885	Lower Pressure Roller MICROSLEEVE™	SF 2216
SF-216HR	45012885	Lower Pressure Roller MICROSLEEVE™	SF 2216
SF-216LH	45014025	Lower Pressure Roller Kit Kit Contains: • (1) Lower Pressure Roller MICROSLEEVE™ • (2) Lower Picker Finger	SF 2216

Priced per Picker Finger, sold in Packages of 2.

Priced per Bushing, sold in Bags of 10.

Priced per Picker Finger, sold in Bags of 2.

















Katun Performance Product











© 2004 Katun Corporation

OEM PN	KATUN PN	DESCRIPTION	MODEL NO.
Parts for use in Sharp SF 2216			
SF-220LH	45015435 	Lower Pressure Roller Kit Kit Contains: • (1) Lower Pressure Roller MICROSLEEVE™ • (4) Lower Picker Finger	SF 2216
NROLR1051FCZZ	45012886 	Manual Paper Feed Roller Tire Only	SF 2216
			<i>Priced per Tire, sold in Bags of 10.</i>
CROLP0921FC01	45017033 	Manual Pickup Roller	SF 2216
CROLP0921FC01	45011442 	Manual Pickup Roller Tire Only Ribbed Tire	SF 2216
			<i>Priced per Tire, sold in Bags of 10.</i>
NROLR1049FCZ1	45016482 	Paper Feed Roller	SF 2216
NROLR1049FCZ1	45012632 	Paper Feed Roller Tire Only	SF 2216
			<i>Priced per Tire, sold in Bags of 10.</i>
NROLR0878FCZZ	45017032 	Paper Pickup Roller	SF 2216
NROLR0878FCZZ	45011076 	Paper Pickup Roller Tire Only	SF 2216
			<i>Priced per Tire, sold in Bags of 10.</i>
CBRGP0528FC02	45014521 	Rear Fuser Roller Bushing	SF 2216
			<i>Priced per Bushing, sold in Bags of 10.</i>
NBRGC0136FCZ1	45016755 	Sintered Bronze Bushing	SF 2216
			<i>Priced per Bushing, sold in Packages of 10.</i>
NBRGC0136FCZZ	45016755 	Sintered Bronze Bushing	SF 2216
			<i>Priced per Bushing, sold in Packages of 10.</i>
NROLT1063FCZ2	45013027 	Upper Fuser Roller DURACON™ II	SF 2216
SF-216HU	45013027 	Upper Fuser Roller DURACON™ II	SF 2216
NGERH0443FCZ1	45012819 	Upper Fuser Roller Gear	SF 2216
NGERH1214FCZZ	45012819 	Upper Fuser Roller Gear	SF 2216

For use in
Sharp
Copiers











Central/Eastern Europe
Telephone: 31(0)183-696969
Fax: 31(0)183-629055
E-mail: order@edc.katun.com

OEM PN	KATUN PN	DESCRIPTION	MODEL NO.
Parts for use in Sharp SF 2216			
SF-216UH	45015481 	Upper Fuser Roller Kit Kit Contains: • (1) Upper Fuser Roller Gear • (2) Roller Stopper • (1) Upper Fuser Roller DURACON™ II • (4) Upper Picker Finger • (1) Front Fuser Roller Bushing • (1) Rear Fuser Roller Bushing	SF 2216
PTME-0168FCZZ	45013096 	Upper Picker Finger	SF 2216 <i>Priced per Picker Finger, sold in Packages of 10.</i>
PRNGP0050FCZZ	45012311 	V Ring	SF 2216 <i>Priced per Bag, 4 Seals per Bag.</i>
Parts for use in Sharp SF 2218			
CPLTM4129FC01	45011991 	Charge Plate	SF 2218
SF-216PU	45011991 	Charge Plate	SF 2218
LPLTZ4069FCZZ	45013151 	Corona Screen Grid	SF 2218
LPLTZ5474FCZZ	45013151 	Corona Screen Grid	SF 2218
DWIR-0466CSZZ	45375548 	Corona Wire Spool 50 m / Spool 70µ Oxidized	SF 2218
PTME-0211FCZ1	45020110 	Drum Picker Finger	SF 2218 <i>Priced per Picker Finger, sold in Packages of 2.</i>
RLMPU0495FCZ1	45021123 	Exposure Lamp 170V 310W	SF 2218
RLMPU0495FCZZ	45021123 	Exposure Lamp 170V 310W	SF 2218
CBRGP0525FC02	45014520 	Front Fuser Roller Bushing	SF 2218 <i>Priced per Bushing, sold in Bags of 10.</i>
RLMPU0551FCZZ	45021096 	Heater Lamp 220V 1000W	SF 2218
PTME-0244FCZZ	45013951 	Lower Picker Finger	SF 2218 <i>Priced per Picker Finger, sold in Bags of 2.</i>

OEM PN	KATUN PN	DESCRIPTION	MODEL NO.	
Parts for use in Sharp SF 2218				
NROLR1058FCZ3	45012885 	Lower Pressure Roller MICROSLEEVE™	SF 2218	
SF-216HR	45012885 	Lower Pressure Roller MICROSLEEVE™	SF 2218	
SF-216LH	45014025 	Lower Pressure Roller Kit Kit Contains: • (1) Lower Pressure Roller MICROSLEEVE™ • (2) Lower Picker Finger	SF 2218	
SF-220LH	45015435 	Lower Pressure Roller Kit Kit Contains: • (1) Lower Pressure Roller MICROSLEEVE™ • (4) Lower Picker Finger	SF 2218	
NROLR1051FCZZ	45012886 	Manual Paper Feed Roller Tire Only	SF 2218	<i>Priced per Tire, sold in Bags of 10.</i>
CROLP0921FC01	45017033 	Manual Pickup Roller	SF 2218	
CROLP0921FC01	45011442 	Manual Pickup Roller Tire Only Ribbed Tire	SF 2218	<i>Priced per Tire, sold in Bags of 10.</i>
NROLR1049FCZ1	45016482 	Paper Feed Roller	SF 2218	
NROLR1049FCZ1	45012632 	Paper Feed Roller Tire Only	SF 2218	<i>Priced per Tire, sold in Bags of 10.</i>
NROLR0878FCZZ	45017032 	Paper Pickup Roller	SF 2218	
NROLR0878FCZZ	45011076 	Paper Pickup Roller Tire Only	SF 2218	<i>Priced per Tire, sold in Bags of 10.</i>
CBRGP0528FC02	45014521 	Rear Fuser Roller Bushing	SF 2218	<i>Priced per Bushing, sold in Bags of 10.</i>
NBRGC0136FCZ1	45016755 	Sintered Bronze Bushing	SF 2218	<i>Priced per Bushing, sold in Packages of 10.</i>
NBRGC0136FCZZ	45016755 	Sintered Bronze Bushing	SF 2218	<i>Priced per Bushing, sold in Packages of 10.</i>
NROLT1063FCZ2	45013027 	Upper Fuser Roller DURACON™ II	SF 2218	

For use in
Sharp
Copiers

Central/Eastern Europe
Telephone: 31(0)183-696969
Fax: 31(0)183-629055
E-mail: order@edc.katun.com

OEM PN	KATUN PN	DESCRIPTION	MODEL NO.
Parts for use in Sharp SF 2218			
SF-216HU	45013027 	Upper Fuser Roller DURACON™ II	SF 2218
NGERH0443FCZ1	45012819 	Upper Fuser Roller Gear	SF 2218
NGERH1214FCZZ	45012819 	Upper Fuser Roller Gear	SF 2218
SF-216UH	45015481 	Upper Fuser Roller Kit Kit Contains: <ul style="list-style-type: none"> • (1) Upper Fuser Roller Gear • (2) Roller Stopper • (1) Upper Fuser Roller DURACON™ II • (4) Upper Picker Finger • (1) Front Fuser Roller Bushing • (1) Rear Fuser Roller Bushing 	SF 2218
PTME-0168FCZZ	45013096 	Upper Picker Finger	SF 2218
PRNGP0050FCZZ	45012311 	V Ring	SF 2218
<i>Priced per Picker Finger, sold in Packages of 10.</i>			
<i>Priced per Bag, 4 Seals per Bag.</i>			
Parts for use in Sharp SF 2314			
DWIR-0466CSZZ	45375548 	Corona Wire Spool 50 m / Spool 70µ Oxidized All Applications	SF 2314
UCLE-0004QSZZ	45016510 	Drum Cleaning Blade	SF 2314
CBRGP0525FC02	45014520 	Front Fuser Roller Bushing	SF 2314
<i>Priced per Bushing, sold in Bags of 10.</i>			
SF-214HR	45015480 	Fuser Roller Kit Kit Contains: <ul style="list-style-type: none"> • (1) Lower Pressure Roller • (1) Upper Fuser Roller DURACON™ II • (4) Lower Picker Finger • (1) Upper Fuser Roller Gear • (2) Roller Stopper • (3) Upper Picker Finger • (1) Front Fuser Roller Bushing • (1) Rear Fuser Roller Bushing 	SF 2314
CROLN1026FC33	45012580 	Lower Fuser Cleaning Roller	SF 2314













Katun Performance Product



© 2004 Katun Corporation

OEM PN	KATUN PN	DESCRIPTION	MODEL NO.
--------	----------	-------------	-----------

Parts for use in Sharp SF 2314













LPLTM4746FCZZ	45012562 	Lower Picker Finger	SF 2314	<i>Priced per Picker Finger, sold in Bags of 4.</i>
NROLI1028FCZZ	45012369 	Lower Pressure Roller	SF 2314	
NROLR1049FCZ1	45016482 	Paper Feed Roller	SF 2314	
NROLR1049FCZ1	45012632 	Paper Feed Roller Tire Only	SF 2314	<i>Priced per Tire, sold in Bags of 10.</i>
NROLR0878FCZ1	45016892 	Paper Pickup Roller Tire Only Ribbed Tire	SF 2314	<i>Priced per Tire, sold in Bags of 10.</i>
CBRGP0528FC02	45014521 	Rear Fuser Roller Bushing	SF 2314	<i>Priced per Bushing, sold in Bags of 10.</i>
NROLT1031FCZZ	45012480 	Upper Fuser Roller DURACON™ II	SF 2314	
NGERH0443FCZ1	45012819 	Upper Fuser Roller Gear	SF 2314	
PTME-0168FCZZ	45013096 	Upper Picker Finger	SF 2314	<i>Priced per Picker Finger, sold in Packages of 10.</i>
PRNGP0005GCZZ	45018026 	V Ring	SF 2314	<i>Priced per Seal, sold in Bags of 4.</i>
PRNGP0050FCZZ	45012311 	V Ring	SF 2314	<i>Priced per Bag, 4 Seals per Bag.</i>

Parts for use in Sharp SF 2414, SF 2514

DWIR-0466CSZZ	45375548 	Corona Wire Spool 50 m / Spool 70μ Oxidized All Applications	SF 2414, SF 2514	
UCLE-0004QSZZ	45016510 	Drum Cleaning Blade	SF 2414, SF 2514	
CBRGP0525FC02	45014520 	Front Fuser Roller Bushing	SF 2414, SF 2514	<i>Priced per Bushing, sold in Bags of 10.</i>

For use in
Sharp
Copiers

Central/Eastern Europe
Telephone: 31(0)183-696969
Fax: 31(0)183-629055
E-mail: order@edc.katun.com

OEM PN	KATUN PN	DESCRIPTION	MODEL NO.
Parts for use in Sharp SF 2414, SF 2514			
SF-214HR	45015480 	Fuser Roller Kit Kit Contains: • (1) Lower Pressure Roller • (1) Upper Fuser Roller DURACON™ II • (4) Lower Picker Finger • (1) Upper Fuser Roller Gear • (2) Roller Stopper • (3) Upper Picker Finger • (1) Front Fuser Roller Bushing • (1) Rear Fuser Roller Bushing	SF 2414, SF 2514
CROLN1026FC33	45012580 	Lower Fuser Cleaning Roller	SF 2414, SF 2514
LPLTM4746FCZZ	45012562 	Lower Picker Finger	SF 2414, SF 2514
			<i>Priced per Picker Finger, sold in Bags of 4.</i>
NROLI1028FCZZ	45012369 	Lower Pressure Roller	SF 2414, SF 2514
NROLR1096FCZZ	45012886 	Manual Paper Feed Roller Tire Only	SF 2414
			<i>Priced per Tire, sold in Bags of 10.</i>
NROLR1051FCZZ	45012886 	Manual Paper Feed Roller Tire Only	SF 2514
			<i>Priced per Tire, sold in Bags of 10.</i>
CROLP0921FC01	45017033 	Manual Pickup Roller	SF 2414, SF 2514
CROLP0921FC01	45011442 	Manual Pickup Roller Tire Only Ribbed Tire	SF 2414, SF 2514
			<i>Priced per Tire, sold in Bags of 10.</i>
NROLR1049FCZ1	45016482 	Paper Feed Roller	SF 2414, SF 2514
NROLR1049FCZ1	45012632 	Paper Feed Roller Tire Only	SF 2414, SF 2514
			<i>Priced per Tire, sold in Bags of 10.</i>
NROLR0878FCZ1	45016892 	Paper Pickup Roller Tire Only Ribbed Tire	SF 2414, SF 2514
			<i>Priced per Tire, sold in Bags of 10.</i>
CBRGP0528FC02	45014521 	Rear Fuser Roller Bushing	SF 2414, SF 2514
			<i>Priced per Bushing, sold in Bags of 10.</i>
CROLR1048FC32	45013175 	Reverse Roller Unit Tire Only	SF 2414, SF 2514
			<i>Priced per Tire, sold in Bags of 10.</i>
NROLT1031FCZZ	45012480 	Upper Fuser Roller DURACON™ II	SF 2414, SF 2514



Katun Performance Product

© 2004 Katun Corporation

OEM PN	KATUN PN	DESCRIPTION	MODEL NO.
Parts for use in Sharp SF 2414, SF 2514			
NGERH0443FCZ1	45012819 ◆	Upper Fuser Roller Gear	SF 2414, SF 2514
PTME-0168FCZZ	45013096 ◆	Upper Picker Finger	SF 2414, SF 2514
			<i>Priced per Picker Finger, sold in Packages of 10.</i>
PRNGP0005GCZZ	45018026 ◆	V Ring	SF 2414, SF 2514
			<i>Priced per Seal, sold in Bags of 4.</i>
PRNGP0050FCZZ	45012311 ◆	V Ring	SF 2414, SF 2514
			<i>Priced per Bag, 4 Seals per Bag.</i>
Parts for use in Sharp SF 2530			
SF-330KB	45014529 ◆	160K Maintenance Kit Kit Contains: • (1) Toner Holding Cleaner Unit • (1) Upper Fuser Roller Gear • (1) Lower Pressure Roller • (1) Upper Fuser Roller • (1) Developer Unit Seal	SF 2530
NBRGY0466FCZZ	45576233 ◆	Bearing Various Applications	SF 2530
CPLTM4129FC01	45011991 ◆	Charge Plate	SF 2530
LPLTZ5007FCZZ	45013153 ◆	Corona Screen Grid	SF 2530
DWIR-0466CSZZ	45375548 ◆	Corona Wire Spool 50 m / Spool 70μ Oxidized Transfer, Separation	SF 2530
MSPRT0513FCZZ	45524654 ◆	Corona Wire Spring Stainless Steel Various Applications	SF 2530
			<i>Priced per Spring, sold in Bags of 10.</i>
CCLEZ0117FC31	45010155 ◆	Drum Cleaning Blade	SF 2530
CCLEZ0117FC31	45022581	Drum Cleaning Blade Access By Katun	SF 2530
SF-222BL	45010155 ◆	Drum Cleaning Blade	SF 2530
RLMPU0495FCZ1	45021123 ◆	Exposure Lamp 170V 310W	SF 2530

For use in
Sharp
Copiers

Central/Eastern Europe
Telephone: 31(0)183-696969
Fax: 31(0)183-629055
E-mail: order@edc.katun.com

OEM PN	KATUN PN	DESCRIPTION	MODEL NO.
Parts for use in Sharp SF 2530			
N/P/N	45019752 	Feed Roller Replacement Kit New Style Kit Contains: • (1) Paper Feed Roller • (1) Paper Pickup Roller • (1) Reverse Roller	SF 2530
LBSHZ0330FCZZ	45012446 	Heat Insulating Sleeve	SF 2530 <i>Priced per Heat Sleeve, sold in Bags of 10.</i>
RLMPU0574FCZZ	45021102 	Heater Lamp 220V 900W	SF 2530
CROLN0912FC31	45021394 	Lower Fuser Cleaning Roller	SF 2530
NBRGY0296FCZZ	45013093 	Lower Fuser Roller Bearing	SF 2530
PTME-0174FCZ1	45018041 	Lower Picker Finger	SF 2530 <i>Priced per Picker Finger, sold in Boxes of 10.</i>
NROLI1103FCZZ	45013214 	Lower Pressure Roller MICROSLEEVE™	SF 2530
SF-240LH	45014024 	Lower Pressure Roller Kit Kit Contains: • (1) Lower Pressure Roller MICROSLEEVE™ • (2) Lower Picker Finger	SF 2530
NROLR1051FCZZ	45012886 	Manual Paper Feed Roller Tire Only	SF 2530 <i>Priced per Tire, sold in Bags of 10.</i>
CGUMM0288FC31	45014266 	Manual Paper Pickup Tire Tire Only	SF 2530 <i>Priced per Tire, sold in Bags of 10.</i>
CROLP1115FC01	45014266 	Manual Pickup Roller Tire Only	SF 2530 <i>Priced per Tire, sold in Bags of 10.</i>
CSFTZ2233FC31	45013175 	Manual Reverse Roller Assembly Tire Only	SF 2530 <i>Priced per Tire, sold in Bags of 10.</i>
NROLR1218FCZZ	45018450 	Paper Feed Roller	SF 2530
NROLR1219FCZZ	45018451 	Paper Pickup Roller	SF 2530













Katun Performance Product



© 2004 Katun Corporation

OEM PN	KATUN PN	DESCRIPTION	MODEL NO.
--------	----------	-------------	-----------

Parts for use in Sharp SF 2530















NROLR1219FCZZ	45021458 	Paper Pickup Roller Tire Only	SF 2530	<i>Priced per Tire, sold in Bags of 10.</i>
NROLR1229FCZZ	45018452 	Reverse Roller	SF 2530	
UCLEZ0126FCZ1	45012723 	Toner Holder Seal	SF 2530	
CROLN0935FC35	45017938 	Upper Fuser Cleaning Roller Assembly	SF 2530	
NROLT1280FCZZ	45014437 	Upper Fuser Roller ALUMANA™ Patented TEFLON® coating with reinforcing oxides extends life.	SF 2530	
NBRGY0295FCZZ	45576217 	Upper Fuser Roller Bearing	SF 2530	
NGERH1217FCZZ	45012825 	Upper Fuser Roller Gear	SF 2530	
SF-330UH	45013612 	Upper Fuser Roller Kit Kit Contains: <ul style="list-style-type: none"> • (1) Upper Fuser Roller ALUMANA™ • (1) Upper Fuser Roller Gear • (4) Upper Picker Finger 	SF 2530	
PTME-0168FCZZ	45013096 	Upper Picker Finger	SF 2530	<i>Priced per Picker Finger, sold in Packages of 10.</i>
PRNGP0050FCZZ	45012311 	V Ring	SF 2530	<i>Priced per Bag, 4 Seals per Bag.</i>
PRNGP0051FCZZ	45011640 	V Ring	SF 2530	<i>Priced per Seal, sold in Bags of 4.</i>

Parts for use in Sharp SF 2540

SF-340KB	45014530 	160K Maintenance Kit Kit Contains: <ul style="list-style-type: none"> • (1) Toner Holding Cleaner Unit • (1) Upper Fuser Roller Gear • (1) Lower Pressure Roller • (1) Upper Fuser Roller • (1) Developer Unit Seal 	SF 2540	
NBRGY0466FCZZ	45576233 	Bearing Various Applications	SF 2540	
CPLTM4129FC01	45011991 	Charge Plate	SF 2540	

For use in
Sharp
Copiers

Central/Eastern Europe
Telephone: 31(0)183-696969
Fax: 31(0)183-629055
E-mail: order@edc.katun.com

OEM PN	KATUN PN	DESCRIPTION	MODEL NO.
Parts for use in Sharp SF 2540			
LPLTZ5007FCZZ	45013153 	Corona Screen Grid	SF 2540
DWIR-0466CSZZ	45375548 	Corona Wire Spool 50 m / Spool 70µ Oxidized Transfer, Separation	SF 2540
MSPRT0513FCZZ	45524654 	Corona Wire Spring Stainless Steel Various Applications	SF 2540
CCLEZ0117FC31	45010155 	Drum Cleaning Blade	SF 2540
CCLEZ0117FC31	45022581	Drum Cleaning Blade Access By Katun	SF 2540
SF-222BL	45010155 	Drum Cleaning Blade	SF 2540
RLMPU0495FCZ1	45021123 	Exposure Lamp 170V 310W	SF 2540
N/P/N	45019752 	Feed Roller Replacement Kit New Style Kit Contains: • (1) Paper Feed Roller • (1) Paper Pickup Roller • (1) Reverse Roller	SF 2540
LBSHZ0330FCZZ	45012446 	Heat Insulating Sleeve	SF 2540
RLMPU0516FCZZ	45021090 	Heater Lamp 220V 1200W	SF 2540
CROLN0912FC31	45021394 	Lower Fuser Cleaning Roller	SF 2540
NBRGY0296FCZZ	45013093 	Lower Fuser Roller Bearing	SF 2540
PTME-0174FCZ1	45018041 	Lower Picker Finger	SF 2540
NROLI1103FCZZ	45013214 	Lower Pressure Roller MICROSLEEVE™	SF 2540
SF-240LH	45014024 	Lower Pressure Roller Kit Kit Contains: • (1) Lower Pressure Roller MICROSLEEVE™ • (2) Lower Picker Finger	SF 2540

*Priced per Spring,
sold in Bags of 10.*













*Priced per Heat Sleeve,
sold in Bags of 10.*

*Priced per Picker Finger,
sold in Boxes of 10.*















Katun Performance Product











© 2004 Katun Corporation

OEM PN	KATUN PN	DESCRIPTION	MODEL NO.	
Parts for use in Sharp SF 2540				
NROLR1051FCZZ	45012886 	Manual Paper Feed Roller Tire Only	SF 2540	<i>Priced per Tire, sold in Bags of 10.</i>
CGUMM0288FC31	45014266 	Manual Paper Pickup Tire Tire Only	SF 2540	<i>Priced per Tire, sold in Bags of 10.</i>
CROLP1115FC01	45014266 	Manual Pickup Roller Tire Only	SF 2540	<i>Priced per Tire, sold in Bags of 10.</i>
CSFTZ2233FC31	45013175 	Manual Reverse Roller Assembly Tire Only	SF 2540	<i>Priced per Tire, sold in Bags of 10.</i>
NROLR1218FCZZ	45018450 	Paper Feed Roller	SF 2540	
NROLR1219FCZZ	45018451 	Paper Pickup Roller	SF 2540	
NROLR1219FCZZ	45021458 	Paper Pickup Roller Tire Only	SF 2540	<i>Priced per Tire, sold in Bags of 10.</i>
NROLR1229FCZZ	45018452 	Reverse Roller	SF 2540	
UCLEZ0126FCZ1	45012723 	Toner Holder Seal	SF 2540	
CROLN0935FC35	45017938 	Upper Fuser Cleaning Roller Assembly	SF 2540	
NROLT1281FCZZ	45014437 	Upper Fuser Roller ALUMANA™ Patented TEFLON® coating with reinforcing oxides extends life.	SF 2540	
NBRGY0295FCZZ	45576217 	Upper Fuser Roller Bearing	SF 2540	
NGERH1217FCZZ	45012825 	Upper Fuser Roller Gear	SF 2540	
SF-330UH	45013612 	Upper Fuser Roller Kit Kit Contains: • (1) Upper Fuser Roller ALUMANA™ • (1) Upper Fuser Roller Gear • (4) Upper Picker Finger	SF 2540	
PTME-0168FCZZ	45013096 	Upper Picker Finger	SF 2540	<i>Priced per Picker Finger, sold in Packages of 10.</i>
PRNGP0050FCZZ	45012311 	V Ring	SF 2540	<i>Priced per Bag, 4 Seals per Bag.</i>

For use in
Sharp
Copiers













Central/Eastern Europe
Telephone: 31(0)183-696969
Fax: 31(0)183-629055
E-mail: order@edc.katun.com

OEM PN	KATUN PN	DESCRIPTION	MODEL NO.	
Parts for use in Sharp SF 2540				
PRNGP0051FCZZ	45011640 	V Ring	SF 2540	<i>Priced per Seal, sold in Bags of 4.</i>
Parts for use in Sharp SF 6100, Z 72				
DWIR-0466CSZZ	45375548 	Corona Wire Spool 50 m / Spool 70µ Oxidized All Applications	SF 6100, Z 72	
N/P/N	45010078 	Drum Cleaning Blade	SF 6100, Z 72	
NROLT0799FCZZ	45636852 	Upper Fuser Roller DURACON™ II	SF 6100, Z 72	
CTME-0159FC01	45018040 	Upper Picker Finger	SF 6100, Z 72	<i>Priced per Picker Finger, sold in Boxes of 10.</i>
Parts for use in Sharp SF 7100, SF 7200				
DWIR-0466CSZZ	45375548 	Corona Wire Spool 50 m / Spool 70µ Oxidized All Applications	SF 7200	
MSPRT0513FCZZ	45524654 	Corona Wire Spring Stainless Steel Various Applications	SF 7100, SF 7200	<i>Priced per Spring, sold in Bags of 10.</i>
NBRGC0136FCZZ	45016755 	Sintered Bronze Bushing	SF 7100, SF 7200	<i>Priced per Bushing, sold in Packages of 10.</i>
NBRGC0140FCZZ	45016756 	Sintered Bronze Bushing	SF 7100, SF 7200	<i>Priced per Bushing, sold in Packages of 10.</i>
PRNGP0013FCZZ	45011640 	V Ring	SF 7100, SF 7200	<i>Priced per Seal, sold in Bags of 4.</i>
PRNGP0015FCZZ	45012311 	V Ring	SF 7100, SF 7200	<i>Priced per Bag, 4 Seals per Bag.</i>
Parts for use in Sharp SF 7300, SF 7350				
NBRGY0325FCZZ	45576233 	Bearing Lower Fuser Roller	SF 7300, SF 7350	

OEM PN	KATUN PN	DESCRIPTION	MODEL NO.
Parts for use in Sharp SF 7300, SF 7350			
DWIR-0466CSZZ	45375548 	Corona Wire Spool 50 m / Spool 70µ Oxidized All Applications	SF 7300, SF 7350
MSPRT0513FCZZ	45524654 	Corona Wire Spring Stainless Steel Various Applications	SF 7300, SF 7350 <i>Priced per Spring, sold in Bags of 10.</i>
UCLEZ0080FCZ1	45000386 	Drum Cleaning Blade	SF 7300, SF 7350
UCLEZ0080FCZ1	45022582	Drum Cleaning Blade Access By Katun	SF 7300, SF 7350
RLMPU0360FCZZ	45021201 	Exposure Lamp 160V 250W	SF 7300, SF 7350
CROLN0647FC01	45021398 	Fuser Cleaning Roller FIBRA™ II Enhanced fuser cleaning efficiency.	SF 7300, SF 7350
CROLN0647FC01	45635132 	Fuser Cleaning Roller	SF 7300, SF 7350
SF-732HR	45014026 	Fuser Roller Kit Kit Contains: <ul style="list-style-type: none"> • (1) Upper Fuser Roller ALUMANA™ • (1) Lower Pressure Roller • (1) Fuser Cleaning Roller FIBRA™ II • (1) Upper Fuser Roller Gear • (3) Upper Picker Finger • (3) Roller Stopper • (2) Upper Fuser Roller Bearing • (2) Heat Insulating Sleeve 	SF 7300, SF 7350
LBSHC0228FCZZ	45012446 	Heat Insulating Sleeve	SF 7300, SF 7350 <i>Priced per Heat Sleeve, sold in Bags of 10.</i>
RLMPU0355FCZZ	45021115 	Heater Lamp 220V 900W	SF 7300, SF 7350
LPLTM2865FCZZ <i>Final Inventory</i>	45012561 	Lower Picker Finger	SF 7300, SF 7350 <i>Priced per Picker Finger, sold in Bags of 5.</i>
NROLI0594FCZZ	45636764 	Lower Pressure Roller	SF 7300, SF 7350

For use in
Sharp
Copiers













Central/Eastern Europe
Telephone: 31(0)183-696969
Fax: 31(0)183-629055
E-mail: order@edc.katun.com

OEM PN	KATUN PN	DESCRIPTION	MODEL NO.
Parts for use in Sharp SF 7300, SF 7350			
N/P/N	45013248 	Paper Feed Roller Replacement Kit Tire Only Kit Contains: • (2) Paper Feed Tire A • (3) Paper Feed Tire B	SF 7300, SF 7350
PGUMR0216FCZZ	45012703 	Paper Feed Tire A Tire Only	SF 7300, SF 7350 <i>Priced per Tire, sold in Bags of 10.</i>
PGUMR0217FCZZ	45012481 	Paper Feed Tire B Tire Only Ribbed Tire	SF 7300, SF 7350 <i>Priced per Tire, sold in Bags of 10.</i>
NBRGC0136FCZZ	45016755 	Sintered Bronze Bushing	SF 7300, SF 7350 <i>Priced per Bushing, sold in Packages of 10.</i>
NROLT0593FCZZ	45013171 	Upper Fuser Roller ALUMANA™ Patented TEFLON® coating with reinforcing oxides extends life.	SF 7300, SF 7350
NROLT0593FCZZ	45014839	Upper Fuser Roller Access By Katun	SF 7300, SF 7350
NBRGY0295FCZZ	45576217 	Upper Fuser Roller Bearing	SF 7300, SF 7350
N/P/N	45012816 	Upper Fuser Roller Bearing Kit Kit Contains: • (2) Heat Insulating Sleeve • (2) Upper Fuser Roller Bearing Kit	SF 7300, SF 7350
NGERH0443FCZ1	45012819 	Upper Fuser Roller Gear	SF 7300, SF 7350
CTME-0159FC01	45018040 	Upper Picker Finger	SF 7300, SF 7350 <i>Priced per Picker Finger, sold in Boxes of 10.</i>
PRNGP0015FCZZ	45012311 	V Ring	SF 7300, SF 7350 <i>Priced per Bag, 4 Seals per Bag.</i>
Parts for use in Sharp SF 7320, SF 7370			
DWIR-0466CSZZ	45375548 	Corona Wire Spool 50 m / Spool 70µ Oxidized All Applications	SF 7320, SF 7370
MSPRT0513FCZZ	45524654 	Corona Wire Spring Stainless Steel Various Applications	SF 7320, SF 7370 <i>Priced per Spring, sold in Bags of 10.</i>



Katun Performance Product

© 2004 Katun Corporation

OEM PN	KATUN PN	DESCRIPTION	MODEL NO.
Parts for use in Sharp SF 7320, SF 7370			
UCLEZ0080FCZ1	45000386 	Drum Cleaning Blade	SF 7320, SF 7370
UCLEZ0080FCZ1	45022582	Drum Cleaning Blade Access By Katun	SF 7320, SF 7370
RLMPU0360FCZZ	45021201 	Exposure Lamp 160V 250W	SF 7320, SF 7370
CROLN0647FC01	45021398 	Fuser Cleaning Roller FIBRA™ II Enhanced fuser cleaning efficiency.	SF 7320, SF 7370
CROLN0647FC01	45635132 	Fuser Cleaning Roller	SF 7320, SF 7370
SF-732HR	45014026 	Fuser Roller Kit Kit Contains: <ul style="list-style-type: none"> • (1) Upper Fuser Roller ALUMANA™ • (1) Lower Pressure Roller • (1) Fuser Cleaning Roller FIBRA™ II • (1) Upper Fuser Roller Gear • (3) Upper Picker Finger • (3) Roller Stopper • (2) Upper Fuser Roller Bearing • (2) Heat Insulating Sleeve 	SF 7320, SF 7370
LBSHC0228FCZZ	45012446 	Heat Insulating Sleeve	SF 7320, SF 7370
LPLTM2865FCZZ <i>Final Inventory</i>	45012561 	Lower Picker Finger	SF 7320, SF 7370
NROLI0594FCZ1	45636764 	Lower Pressure Roller	SF 7320, SF 7370
N/P/N	45013248 	Paper Feed Roller Replacement Kit Tire Only Kit Contains: <ul style="list-style-type: none"> • (2) Paper Feed Tire A • (3) Paper Feed Tire B 	SF 7320, SF 7370
PGUMR0216FCZZ	45012703 	Paper Feed Tire A Tire Only	SF 7320, SF 7370
PGUMR0217FCZZ	45012481 	Paper Feed Tire B Tire Only Ribbed Tire	SF 7320, SF 7370
NBRGC0136FCZZ	45016755 	Sintered Bronze Bushing	SF 7320, SF 7370

*Priced per Heat Sleeve,
sold in Bags of 10.*

*Priced per Picker Finger,
sold in Bags of 5.*













*Priced per Tire,
sold in Bags of 10.*

*Priced per Tire,
sold in Bags of 10.*

*Priced per Bushing,
sold in Packages of 10.*

For use in
Sharp
Copiers

Central/Eastern Europe
Telephone: 31(0)183-696969
Fax: 31(0)183-629055
E-mail: order@edc.katun.com

OEM PN	KATUN PN	DESCRIPTION	MODEL NO.
Parts for use in Sharp SF 7320, SF 7370			
NROLT0867FCZZ	45013171 	Upper Fuser Roller ALUMANA™ Patented TEFLON® coating with reinforcing oxides extends life.	SF 7320, SF 7370
NROLT0867FCZZ	45014839	Upper Fuser Roller Access By Katun	SF 7320, SF 7370
NBRGY0295FCZZ	45576217 	Upper Fuser Roller Bearing	SF 7320, SF 7370
N/P/N	45012816 	Upper Fuser Roller Bearing Kit Kit Contains: • (2) Heat Insulating Sleeve • (2) Upper Fuser Roller Bearing Kit	SF 7320, SF 7370
NGERH0443FCZ1	45012819 	Upper Fuser Roller Gear	SF 7320, SF 7370
CTME-0159FC01	45018040 	Upper Picker Finger	SF 7320, SF 7370
PRNGP0015FCZZ	45012311 	V Ring	SF 7320, SF 7370
			<i>Priced per Picker Finger, sold in Boxes of 10.</i>
			<i>Priced per Bag, 4 Seals per Bag.</i>
Parts for use in Sharp SF 7500			
DWIR-0466CSZZ	45375548 	Corona Wire Spool 50 m / Spool 70μ Oxidized All Applications	SF 7500
MSPRT0513FCZZ	45524654 	Corona Wire Spring Stainless Steel Various Applications	SF 7500
NBRGC0136FCZZ	45016755 	Sintered Bronze Bushing	SF 7500
0DJ43426601//	45247060 	Upper Picker Finger	SF 7500
			<i>Priced per Spring, sold in Bags of 10.</i>
			<i>Priced per Bushing, sold in Packages of 10.</i>
			<i>Priced per Picker Finger, sold in Packages of 10.</i>
Parts for use in Sharp SF 7700, SF 7750			
NBRGY0325FCZZ	45576233 	Bearing Lower Fuser Roller	SF 7700, SF 7750
DWIR-0466CSZZ	45375548 	Corona Wire Spool 50 m / Spool 70μ Oxidized All Applications	SF 7700, SF 7750











Katun Performance Product

© 2004 Katun Corporation

OEM PN	KATUN PN	DESCRIPTION	MODEL NO.
--------	----------	-------------	-----------

Parts for use in Sharp SF 7700, SF 7750













MSPRT0513FCZZ	45524654 	Corona Wire Spring Stainless Steel Various Applications	SF 7700, SF 7750	<i>Priced per Spring, sold in Bags of 10.</i>
UCLEZ0069FCZZ	45244553 	Drum Cleaning Blade	SF 7700, SF 7750	
RLMPU0346FCZZ	45021113 	Heater Lamp 220V 850W	SF 7700, SF 7750	
NROLI0550FCZ1	45636366 	Lower Pressure Roller	SF 7700, SF 7750	
NBRGC0136FCZZ	45016755 	Sintered Bronze Bushing	SF 7700, SF 7750	<i>Priced per Bushing, sold in Packages of 10.</i>
NBRGC0140FCZZ	45016756 	Sintered Bronze Bushing	SF 7700, SF 7750	<i>Priced per Bushing, sold in Packages of 10.</i>
NROLT0549FCZZ	45636365 	Upper Fuser Roller DURACON™ II	SF 7700, SF 7750	
NBRGY0285FCZZ	45576216 	Upper Fuser Roller Bearing	SF 7700, SF 7750	
PTME-0168FCZZ	45013096 	Upper Picker Finger	SF 7700, SF 7750	<i>Priced per Picker Finger, sold in Packages of 10.</i>

Parts for use in Sharp SF 7800, SF 7830, SF 7850

NBRGY0325FCZZ	45576233 	Bearing Lower Fuser Roller	SF 7800, SF 7830, SF 7850	
DWIR-0466CSZZ	45375548 	Corona Wire Spool 50 m / Spool 70μ Oxidized All Applications	SF 7800, SF 7830, SF 7850	
MSPRT0513FCZZ	45524654 	Corona Wire Spring Stainless Steel Various Applications	SF 7800, SF 7830, SF 7850	<i>Priced per Spring, sold in Bags of 10.</i>
UCLEZ0108FCZ1	45000401 	Drum Cleaning Blade	SF 7800, SF 7830, SF 7850	
UCLEZ0108FCZ1	45022580	Drum Cleaning Blade Access By Katun	SF 7800, SF 7830, SF 7850	
N/P/N	45020110 	Drum Picker Finger	SF 7800, SF 7830, SF 7850	<i>Priced per Picker Finger, sold in Packages of 2.</i>
RLMPU0335FCZZ	45021184 	Exposure Lamp 170V 310W	SF 7800, SF 7830, SF 7850	

For use in
Sharp
Copiers













Central/Eastern Europe
Telephone: 31(0)183-696969
Fax: 31(0)183-629055
E-mail: order@edc.katun.com

OEM PN	KATUN PN	DESCRIPTION	MODEL NO.
Parts for use in Sharp SF 7800, SF 7830, SF 7850			
N/P/N	45013143 	Feed Tire Replacement Kit Tire Only Kit Contains: • (2) Paper Feed Tire A • (2) Paper Feed Tire B	SF 7800, SF 7830, SF 7850
SF-780HR	45014098 	Fuser Roller Kit Kit Contains: • (1) Upper Fuser Roller DURACON™ II • (1) Lower Pressure Roller • (1) Lower Fuser Cleaning Roller Assembly • (2) Upper Fuser Roller Bushing • (1) Upper Fuser Roller Gear • (4) Upper Picker Finger • (5) Lower Picker Finger • (3) Roller Stopper • (1) Upper Fuser Cleaning Roller	SF 7800, SF 7830, SF 7850
RLMPU0446FCZZ	45021086 	Heater Lamp 220V 850W	SF 7800, SF 7830, SF 7850
CROLN0834FC01	45021395 	Lower Fuser Cleaning Roller Assembly	SF 7800, SF 7830, SF 7850
LPLTM2865FCZZ <i>Final Inventory</i>	45012561 	Lower Picker Finger	SF 7800, SF 7830, SF 7850 <i>Priced per Picker Finger, sold in Bags of 5.</i>
NROLI0836FCZZ	45636366 	Lower Pressure Roller	SF 7800, SF 7830, SF 7850
PGUMR0220FCZZ	45012748 	Paper Feed Tire A Tire Only	SF 7800, SF 7830, SF 7850 <i>Priced per Tire, sold in Bags of 10.</i>
PGUMR0221FCZZ	45012773 	Paper Feed Tire B Tire Only	SF 7800, SF 7830, SF 7850 <i>Priced per Tire, sold in Bags of 10.</i>
NBRGC0136FCZZ	45016755 	Sintered Bronze Bushing	SF 7800, SF 7830, SF 7850 <i>Priced per Bushing, sold in Packages of 10.</i>
CROLN0874FC31	45021424 	Upper Fuser Cleaning Roller	SF 7800, SF 7830, SF 7850
NROLT0835FCZZ	45636365 	Upper Fuser Roller DURACON™ II	SF 7800, SF 7830, SF 7850
NBRGP0416FCZZ <i>Final Inventory</i>	45013471 	Upper Fuser Roller Bushing	SF 7800, SF 7830, SF 7850 <i>Priced per Bushing, sold in Bags of 10.</i>
NGERH0443FCZ1	45012819 	Upper Fuser Roller Gear	SF 7800, SF 7830, SF 7850















Katun Performance Product

© 2004 Katun Corporation

OEM PN	KATUN PN	DESCRIPTION	MODEL NO.	
Parts for use in Sharp SF 7800, SF 7830, SF 7850				
PTME-0168FCZZ	45013096 	Upper Picker Finger	SF 7800, SF 7830, SF 7850	<i>Priced per Picker Finger, sold in Packages of 10.</i>
PRNGP0015FCZZ	45012311 	V Ring	SF 7800, SF 7830, SF 7850	<i>Priced per Bag, 4 Seals per Bag.</i>
Parts for use in Sharp SF 7900, SF 8300, SF 8350, SF 8400				
SF-830KB <i>Final Inventory</i>	45011059 	120K Maintenance Kit Kit Contains: <ul style="list-style-type: none"> • (1) Upper Fuser Roller • (1) Lower Pressure Roller • (2) Lower Picker Finger • (1) Drum Cleaning Blade • (1) Toner Hold Plate Seal • (1) Developer Unit Lower Seal • (4) Upper Picker Finger 	SF 7900, SF 8300, SF 8350, SF 8400	
DWIR-0466CSZZ	45375548 	Corona Wire Spool 50 m / Spool 70μ Oxidized All Applications	SF 7900, SF 8300, SF 8350, SF 8400	
MSPRT0513FCZZ	45524654 	Corona Wire Spring Stainless Steel Various Applications	SF 7900	<i>Priced per Spring, sold in Bags of 10.</i>
UCLEZ0099FCZZ	45243424 	Drum Cleaning Blade	SF 7900, SF 8300, SF 8350, SF 8400	
RLMPU0335FCZZ	45021184 	Exposure Lamp 170V 310W	SF 7900, SF 8300, SF 8350, SF 8400	
LBSHC0228FCZZ	45012446 	Heat Insulating Sleeve	SF 7900, SF 8300, SF 8350, SF 8400	<i>Priced per Heat Sleeve, sold in Bags of 10.</i>
NBRGY0296FCZZ	45013093 	Lower Fuser Roller Bearing	SF 7900, SF 8300, SF 8350, SF 8400	
PTME-0174FCZ1	45018041 	Lower Picker Finger	SF 7900, SF 8300, SF 8400	<i>Priced per Picker Finger, sold in Boxes of 10.</i>
NROLI0583FCZZ	45013214 	Lower Pressure Roller MICROSLEEVE™	SF 7900, SF 8300, SF 8350, SF 8400	
NROLI0583FCZZ	45636769 	Lower Pressure Roller	SF 7900, SF 8300, SF 8350, SF 8400	
NROLP0648FCZZ	45013146 	Paper Feed Roller Tire Only	SF 7900, SF 8300, SF 8350, SF 8400	<i>Priced per Tire, sold in Bags of 10.</i>

For use in
Sharp
Copiers

Central/Eastern Europe
Telephone: 31(0)183-696969
Fax: 31(0)183-629055
E-mail: order@edc.katun.com

OEM PN	KATUN PN	DESCRIPTION	MODEL NO.	
Parts for use in Sharp SF 7900, SF 8300, SF 8350, SF 8400				
PGUMM0187FCZZ	45013444 	Paper Feed Roller 250 Tire Only	SF 7900, SF 8300, SF 8350, SF 8400	<i>Priced per Tire, sold in Bags of 4.</i>
PGUMM0186FCZZ	45012877 	Paper Feed Roller 500 Tire Only	SF 7900, SF 8300, SF 8350, SF 8400	<i>Priced per Tire, sold in Bags of 8.</i>
NBRGC0136FCZZ	45016755 	Sintered Bronze Bushing	SF 7900, SF 8300, SF 8350, SF 8400	<i>Priced per Bushing, sold in Packages of 10.</i>
NBRGC0140FCZZ	45016756 	Sintered Bronze Bushing	SF 7900, SF 8300, SF 8350, SF 8400	<i>Priced per Bushing, sold in Packages of 10.</i>
CSRA-0029FC31	45010160 	Toner Hold Plate Seal	SF 7900, SF 8300, SF 8350, SF 8400	
CROLN0728FC32	45016812 	Upper Fuser Cleaning Roller	SF 7900, SF 8300, SF 8350, SF 8400	
NROLT0719FCZ1	45014437 	Upper Fuser Roller ALUMANA™ Patented TEFLON® coating with reinforcing oxides extends life.	SF 7900, SF 8300, SF 8350, SF 8400	
NROLT0719FCZ1	45014840	Upper Fuser Roller Access By Katun	SF 7900, SF 8300, SF 8350, SF 8400	
NBRGY0295FCZZ	45576217 	Upper Fuser Roller Bearing	SF 7900, SF 8300, SF 8350, SF 8400	
N/P/N	45012816 	Upper Fuser Roller Bearing Kit Kit Contains: • (2) Heat Insulating Sleeve • (2) Upper Fuser Roller Bearing Kit	SF 7900, SF 8300, SF 8350, SF 8400	
NGERH0475FCZ1	45012825 	Upper Fuser Roller Gear	SF 7900, SF 8300, SF 8400	
PTME-0149FCZZ	45013096 	Upper Picker Finger	SF 7900, SF 8300, SF 8350, SF 8400	<i>Priced per Picker Finger, sold in Packages of 10.</i>
PRNGP0013FCZZ	45011640 	V Ring	SF 7900	<i>Priced per Seal, sold in Bags of 4.</i>
PRNGP0015FCZZ	45012311 	V Ring	SF 7900	<i>Priced per Bag, 4 Seals per Bag.</i>



Katun Performance Product



© 2004 Katun Corporation

OEM PN	KATUN PN	DESCRIPTION	MODEL NO.
-----------	-------------	-------------	--------------

Parts for use in Sharp SF 8100, SF 8260













DWIR-0466CSZZ	45375548 	Corona Wire Spool 50 m / Spool 70μ Oxidized All Applications	SF 8100, SF 8260
MSPRT0513FCZZ	45524654 	Corona Wire Spring Stainless Steel Various Applications	SF 8100, SF 8260 <i>Priced per Spring, sold in Bags of 10.</i>
UCLEZ0069FCZZ	45244553 	Drum Cleaning Blade	SF 8100, SF 8260
RLMPU0322FCZZ	45021182 	Exposure Lamp 170V 275W	SF 8100
RLMPU0335FCZZ	45021184 	Exposure Lamp 170V 310W	SF 8260
SF-810RL	45021570 	Fuser Roller Cleaning Kit	SF 8100, SF 8260
NBRGY0253FCZZ	45576205 	Lower Fuser Roller Bearing	SF 8100, SF 8260
NBRGC0136FCZZ	45016755 	Sintered Bronze Bushing	SF 8100, SF 8260 <i>Priced per Bushing, sold in Packages of 10.</i>
NROLT0506FCZZ	45636367 	Upper Fuser Roller OEM Type	SF 8100, SF 8260
NBRGY0255FCZZ	45021526 	Upper Fuser Roller Bearing	SF 8100, SF 8260
PTME-0149FCZZ	45013096 	Upper Picker Finger	SF 8100, SF 8260 <i>Priced per Picker Finger, sold in Packages of 10.</i>
PRNGP0013FCZZ	45011640 	V Ring	SF 8100, SF 8260 <i>Priced per Seal, sold in Bags of 4.</i>
PRNGP0015FCZZ	45012311 	V Ring	SF 8100, SF 8260 <i>Priced per Bag, 4 Seals per Bag.</i>

Parts for use in Sharp SF 8200

















NBRGY0131FCZZ	45576204 	Bearing Various Applications	SF 8200
DWIR-0466CSZZ	45375548 	Corona Wire Spool 50 m / Spool 70μ Oxidized All Applications	SF 8200

For use in
Sharp
Copiers

Central/Eastern Europe
Telephone: 31(0)183-696969
Fax: 31(0)183-629055
E-mail: order@edc.katun.com













OEM PN	KATUN PN	DESCRIPTION	MODEL NO.
Parts for use in Sharp SF 8200			
MSPRT0513FCZZ	45524654 	Corona Wire Spring Stainless Steel Various Applications	SF 8200 <i>Priced per Spring, sold in Bags of 10.</i>
UCLEZ0069FCZZ	45244553 	Drum Cleaning Blade	SF 8200
NBRGC0200FCZZ	45576107 	Lower Fuser Roller Bearing	SF 8200
NBRGC0136FCZZ	45016755 	Sintered Bronze Bushing	SF 8200 <i>Priced per Bushing, sold in Packages of 10.</i>
NBRGY0199FCZZ	45021526 	Upper Fuser Roller Bearing	SF 8200
PRNGP0013FCZZ	45011640 	V Ring	SF 8200 <i>Priced per Seal, sold in Bags of 4.</i>
PRNGP0015FCZZ	45012311 	V Ring	SF 8200 <i>Priced per Bag, 4 Seals per Bag.</i>
Parts for use in Sharp SF 8500, SF 8570, SF 8800, SF 8870			
N/P/N	45009116 	Convenience Kit Kit Contains: • (1) Upper Fuser Cleaning Roller • (1) Drum Cleaning Blade • (1) Lower Fuser Cleaning Roller	SF 8500, SF 8800
DWIR-0466CSZZ	45375548 	Corona Wire Spool 50 m / Spool 70µ Oxidized All Applications	SF 8500, SF 8570, SF 8800, SF 8870
MSPRT0513FCZZ	45524654 	Corona Wire Spring Stainless Steel Various Applications	SF 8500, SF 8570, SF 8800, SF 8870 <i>Priced per Spring, sold in Bags of 10.</i>
UCLEZ0078FCZ4	45243495 	Drum Cleaning Blade	SF 8500, SF 8570, SF 8800, SF 8870
UCLEZ0078FCZ4	45022583	Drum Cleaning Blade Access By Katun	SF 8500, SF 8570, SF 8800, SF 8870
RLMPU0362FCZZ	45021182 	Exposure Lamp 170V 275W	SF 8500, SF 8570, SF 8800, SF 8870
LBSHC0228FCZZ	45012446 	Heat Insulating Sleeve	SF 8500, SF 8570, SF 8800, SF 8870 <i>Priced per Heat Sleeve, sold in Bags of 10.</i>
NROLN0587FCZZ	45021510 	Lower Fuser Cleaning Roller	SF 8500, SF 8570, SF 8800, SF 8870



OEM PN	KATUN PN	DESCRIPTION	MODEL NO.
Parts for use in Sharp SF 8500, SF 8570, SF 8800, SF 8870			
NBRGY0296FCZZ	45013093 	Lower Fuser Roller Bearing	SF 8500, SF 8570, SF 8800, SF 8870
PTME-0174FCZ1	45018041 	Lower Picker Finger	SF 8500, SF 8570, SF 8800, SF 8870
			<i>Priced per Picker Finger, sold in Boxes of 10.</i>
NROLI0583FCZZ	45013214 	Lower Pressure Roller MICROSLEEVE™	SF 8500, SF 8570, SF 8800, SF 8870
NROLI0583FCZZ	45636769 	Lower Pressure Roller	SF 8500, SF 8570, SF 8800, SF 8870
NROLR0603FCZZ	45013136 	Manual Paper Feed Roller Tire Only	SF 8500, SF 8570, SF 8800, SF 8870
			<i>Priced per Tire, sold in Bags of 10.</i>
NROLR0577FCZ1	45012755 	Paper Feed Roller 250 Tire Only	SF 8500, SF 8570, SF 8800, SF 8870
			<i>Priced per Tire, sold in Bags of 4.</i>
CGUMR0184FC31	45011087 	Paper Feed Tire 500 Tire Only	SF 8500, SF 8570, SF 8800, SF 8870
			<i>Priced per Set, 4 Tires per Set.</i>
NBRGC0136FCZZ	45016755 	Sintered Bronze Bushing	SF 8500, SF 8570, SF 8800, SF 8870
			<i>Priced per Bushing, sold in Packages of 10.</i>
NBRGC0140FCZZ	45016756 	Sintered Bronze Bushing	SF 8500, SF 8570, SF 8800, SF 8870
			<i>Priced per Bushing, sold in Packages of 10.</i>
CPLTM2875FC31 <i>Final Inventory</i>	45011153 	Toner Seal Plate	SF 8500, SF 8570, SF 8800, SF 8870
CROLN0586FC31	45016812 	Upper Fuser Cleaning Roller	SF 8500, SF 8570, SF 8800, SF 8870
NROLT0582FCZZ	45013170 	Upper Fuser Roller ALUMANA™ Patented TEFLON® coating with reinforcing oxides extends life.	SF 8800
NROLT0613FCZZ	45013170 	Upper Fuser Roller ALUMANA™ Patented TEFLON® coating with reinforcing oxides extends life.	SF 8500, SF 8570, SF 8870
NBRGY0295FCZZ	45576217 	Upper Fuser Roller Bearing	SF 8500, SF 8570, SF 8800, SF 8870
N/P/N	45012816 	Upper Fuser Roller Bearing Kit Kit Contains: • (2) Heat Insulating Sleeve • (2) Upper Fuser Roller Bearing Kit	SF 8500, SF 8570, SF 8800, SF 8870
NGERH0475FCZ1	45012825 	Upper Fuser Roller Gear	SF 8500, SF 8570, SF 8800, SF 8870

For use in
Sharp
Copiers















Central/Eastern Europe
Telephone: 31(0)183-696969
Fax: 31(0)183-629055
E-mail: order@edc.katun.com

OEM PN	KATUN PN	DESCRIPTION	MODEL NO.	
Parts for use in Sharp SF 8500, SF 8570, SF 8800, SF 8870				
PTME-0149FCZZ	45013096 	Upper Picker Finger	SF 8500, SF 8570, SF 8800, SF 8870	<i>Priced per Picker Finger, sold in Packages of 10.</i>
PRNGP0013FCZZ	45011640 	V Ring	SF 8500, SF 8570, SF 8800, SF 8870	<i>Priced per Seal, sold in Bags of 4.</i>
PRNGP0015FCZZ	45012311 	V Ring	SF 8500, SF 8570, SF 8800, SF 8870	<i>Priced per Bag, 4 Seals per Bag.</i>
Parts for use in Sharp SF 8600, SF 9300				
NBRGY0131FCZZ	45576204 	Bearing Various Applications	SF 8600, SF 9300	
DWIR-0466CSZZ	45375548 	Corona Wire Spool 50 m / Spool 70µ Oxidized All Applications	SF 8600, SF 9300	
DWIR-0467CSZZ	45375229 	Corona Wire Spool Platinum alloy clad technology extends corona wire life. 70µ 7.5 m / Spool All Applications	SF 8600, SF 9300	
MSPRT0513FCZZ	45524654 	Corona Wire Spring Stainless Steel Various Applications	SF 8600, SF 9300	<i>Priced per Spring, sold in Bags of 10.</i>
NBRGY0232FCZZ	45016005 	Lower Fuser Roller Bearing	SF 8600, SF 9300	
NBRGC0136FCZZ	45016755 	Sintered Bronze Bushing	SF 8600, SF 9300	<i>Priced per Bushing, sold in Packages of 10.</i>
NBRGC0140FCZZ	45016756 	Sintered Bronze Bushing	SF 8600, SF 9300	<i>Priced per Bushing, sold in Packages of 10.</i>
PRNGP0013FCZZ	45011640 	V Ring	SF 8600, SF 9300	<i>Priced per Seal, sold in Bags of 4.</i>
PRNGP0015FCZZ	45012311 	V Ring	SF 8600, SF 9300	<i>Priced per Bag, 4 Seals per Bag.</i>



Katun Performance Product

© 2004 Katun Corporation









OEM PN	KATUN PN	DESCRIPTION	MODEL NO.
Parts for use in Sharp SF 9400			
DWIR-0466CSZZ	45375548 	Corona Wire Spool 50 m / Spool 70µ Oxidized All Applications	SF 9400
MSPRT0513FCZZ	45524654 	Corona Wire Spring Stainless Steel Various Applications	SF 9400
<i>Priced per Spring, sold in Bags of 10.</i>			
UCLEZ0078FCZ4	45243495 	Drum Cleaning Blade	SF 9400
UCLEZ0078FCZ4	45022583 	Drum Cleaning Blade Access By Katun	SF 9400
RLMPU0362FCZZ	45021182 	Exposure Lamp 170V 275W	SF 9400
LBSHC0334FCZZ	45014855 	Heat Insulating Sleeve	SF 9400
<i>Priced per Set, 2 Heat Sleeves per Set.</i>			
LBSHZ0178FCZ1	45014855 	Heat Insulating Sleeve	SF 9400
<i>Priced per Set, 2 Heat Sleeves per Set.</i>			
NROLR0603FCZZ	45013136 	Manual Paper Feed Roller Tire Only	SF 9400
<i>Priced per Tire, sold in Bags of 10.</i>			
NBRGC0136FCZZ	45016755 	Sintered Bronze Bushing	SF 9400
<i>Priced per Bushing, sold in Packages of 10.</i>			
NBRGC0140FCZZ	45016756 	Sintered Bronze Bushing	SF 9400
<i>Priced per Bushing, sold in Packages of 10.</i>			
CPLTM2875FC31 <i>Final Inventory</i>	45011153 	Toner Seal Plate	SF 9400
NBRGY0215FCZZ	45021527 	Upper Fuser Roller Bearing	SF 9400
PRNGP0013FCZZ	45011640 	V Ring	SF 9400
<i>Priced per Seal, sold in Bags of 4.</i>			
PRNGP0015FCZZ	45012311 	V Ring	SF 9400
<i>Priced per Bag, 4 Seals per Bag.</i>			

Parts for use in Sharp SF 9500, SF 9550

NBRGY0131FCZZ	45576204 	Bearing Various Applications	SF 9500, SF 9550
---------------	---	--	------------------

For use in
Sharp
Copiers

Central/Eastern Europe
Telephone: 31(0)183-696969
Fax: 31(0)183-629055
E-mail: order@edc.katun.com



OEM PN	KATUN PN	DESCRIPTION	MODEL NO.
Parts for use in Sharp SF 9500, SF 9550			
NBRGY0325FCZZ	45576233 	Bearing Various Applications	SF 9500, SF 9550
DWIR-0466CSZZ	45375548 	Corona Wire Spool 50 m / Spool 70µ Oxidized All Applications	SF 9500, SF 9550
DWIR-0467CSZZ	45375229 	Corona Wire Spool Platinum alloy clad technology extends corona wire life. 70µ 7.5 m / Spool All Applications	SF 9500, SF 9550
MSPRT0513FCZZ	45524654 	Corona Wire Spring Stainless Steel Various Applications	SF 9500, SF 9550 <i>Priced per Spring, sold in Bags of 10.</i>
LBSHC0334FCZZ	45014855 	Heat Insulating Sleeve	SF 9500, SF 9550 <i>Priced per Set, 2 Heat Sleeves per Set.</i>
LBSHZ0178FCZ1	45014855 	Heat Insulating Sleeve	SF 9500, SF 9550 <i>Priced per Set, 2 Heat Sleeves per Set.</i>
CROLN0526FC31	45021380 	Lower Fuser Cleaning Roller	SF 9500, SF 9550
NBRGC0140FCZZ	45016756 	Sintered Bronze Bushing	SF 9500 <i>Priced per Bushing, sold in Packages of 10.</i>
NBRGC0136FCZZ	45016755 	Sintered Bronze Bushing	SF 9500, SF 9550 <i>Priced per Bushing, sold in Packages of 10.</i>
CROLN0430FC33	45632511 	Upper Fuser Cleaning Roller with Bushings and Gear	SF 9500, SF 9550
NBRGY0215FCZZ	45021527 	Upper Fuser Roller Bearing	SF 9500, SF 9550
NGERH0842FCZZ	45015022 	Upper Fuser Roller Gear	SF 9500, SF 9550
PRNGP0013FCZZ	45011640 	V Ring	SF 9500, SF 9550 <i>Priced per Seal, sold in Bags of 4.</i>

Parts for use in Sharp SF 9600







NBRGY0131FCZZ	45576204 	Bearing Various Applications	SF 9600
---------------	---	--	---------

OEM PN	KATUN PN	DESCRIPTION	MODEL NO.
--------	----------	-------------	-----------

Parts for use in Sharp SF 9600

DWIR-0466CSZZ	45375548 	Corona Wire Spool 50 m / Spool 70μ Oxidized All Applications	SF 9600	
DWIR-0467CSZZ	45375229 	Corona Wire Spool Platinum alloy clad technology extends corona wire life. 70μ 7.5 m / Spool All Applications	SF 9600	
MSPRT0513FCZZ	45524654 	Corona Wire Spring Stainless Steel Various Applications	SF 9600	<i>Priced per Spring, sold in Bags of 10.</i>
NBRGC0136FCZZ	45016755 	Sintered Bronze Bushing	SF 9600	<i>Priced per Bushing, sold in Packages of 10.</i>
NBRGY0213FCZZ	45576209 	Upper Fuser Roller Bearing	SF 9600	
PRNGP0013FCZZ	45011640 	V Ring	SF 9600	<i>Priced per Seal, sold in Bags of 4.</i>
PRNGP0015FCZZ	45012311 	V Ring	SF 9600	<i>Priced per Bag, 4 Seals per Bag.</i>

Parts for use in Sharp SF 9700, SF 9750, SF 9800

NBRGY0131FCZZ	45576204 	Bearing Various Applications	SF 9700, SF 9750, SF 9800	
NBRGY0325FCZZ	45576233 	Bearing Various Applications	SF 9800	
DWIR-0466CSZZ	45375548 	Corona Wire Spool 50 m / Spool 70μ Oxidized All Applications	SF 9700, SF 9750	
DWIR-0467CSZZ	45375229 	Corona Wire Spool Platinum alloy clad technology extends corona wire life. 70μ 7.5 m / Spool All Applications	SF 9700, SF 9750, SF 9800	
MSPRT0513FCZZ	45524654 	Corona Wire Spring Stainless Steel Various Applications	SF 9700, SF 9750, SF 9800	<i>Priced per Spring, sold in Bags of 10.</i>
CACLE-0076FC01	45001081 	Drum Cleaning Blade	SF 9700, SF 9750, SF 9800	

For use in
Sharp
Copiers

Central/Eastern Europe
Telephone: 31(0)183-696969
Fax: 31(0)183-629055
E-mail: order@edc.katun.com

OEM PN	KATUN PN	DESCRIPTION	MODEL NO.	
Parts for use in Sharp SF 9700, SF 9750, SF 9800				
SF-970BL	45001081	Drum Cleaning Blade	SF 9700, SF 9750, SF 9800	
LBSHC0334FCZZ	45014855	Heat Insulating Sleeve	SF 9700, SF 9750, SF 9800	<i>Priced per Set, 2 Heat Sleeves per Set.</i>
LBSHZ0178FCZ1	45014855	Heat Insulating Sleeve	SF 9700, SF 9750, SF 9800	<i>Priced per Set, 2 Heat Sleeves per Set.</i>
CROLN0526FC31	45021380	Lower Fuser Cleaning Roller	SF 9700, SF 9750, SF 9800	
OCW2094P162A/	45636643	Original Feed Roller Tire Only	SF 9700, SF 9750, SF 9800	<i>Priced per Tire, sold in Bags of 10.</i>
NROLR0878FCZZ	45017032	Paper Pickup Roller	SF 9700, SF 9750, SF 9800	
NROLR0878FCZZ	45011076	Paper Pickup Roller Tire Only	SF 9700, SF 9750, SF 9800	<i>Priced per Tire, sold in Bags of 10.</i>
NBRGC0136FCZZ	45016755	Sintered Bronze Bushing	SF 9700, SF 9750, SF 9800	<i>Priced per Bushing, sold in Packages of 10.</i>
CROLN0430FC33	45632511	Upper Fuser Cleaning Roller with Bushings and Gear	SF 9700, SF 9750, SF 9800	
NBRGY0215FCZZ	45021527	Upper Fuser Roller Bearing	SF 9700, SF 9750, SF 9800	
NGERH0842FCZZ	45015022	Upper Fuser Roller Gear	SF 9700, SF 9750, SF 9800	
PRNGP0013FCZZ	45011640	V Ring	SF 9700, SF 9750, SF 9800	<i>Priced per Seal, sold in Bags of 4.</i>
Parts for use in Sharp Z 25				
CGUMM0288FC31	45014266	Manual Paper Pickup Tire Tire Only	Z 25	<i>Priced per Tire, sold in Bags of 10.</i>
NROLP0648FCZZ	45013146	Paper Feed Roller Tire Only	Z 25	<i>Priced per Tire, sold in Bags of 10.</i>





Katun Performance Product

© 2004 Katun Corporation

OEM PN	KATUN PN	DESCRIPTION	MODEL NO.
--------	----------	-------------	-----------





Parts for use in Sharp Z 27

CGUMM0288FC31	45014266 	Manual Paper Pickup Tire Tire Only	Z 27	<i>Priced per Tire, sold in Bags of 10.</i>
NROLP0648FCZZ	45013146 	Paper Feed Roller Tire Only	Z 27	<i>Priced per Tire, sold in Bags of 10.</i>

Parts for use in Sharp Z 30

DWIR-0466CSZZ	45375548 	Corona Wire Spool 50 m / Spool 70μ Oxidized All Applications	Z 30	
UCLEZ0085FCZZ	45011152 	Drum Cleaning Blade	Z 30	
NROLP0648FCZZ	45013146 	Paper Feed Roller Tire Only	Z 30	<i>Priced per Tire, sold in Bags of 10.</i>
CTME-0159FC01	45018040 	Upper Picker Finger	Z 30	<i>Priced per Picker Finger, sold in Boxes of 10.</i>

Parts for use in Sharp Z 50, Z 52, Z 55, Z 70, Z 85, Z 85 II, Z 87, Z 88















DWIR-0466CSZZ	45375548 	Corona Wire Spool 50 m / Spool 70μ Oxidized All Applications	Z 50, Z 52, Z 70, Z 85	
N/P/N	45010078 	Drum Cleaning Blade	Z 50, Z 52, Z 55, Z 70, Z 85, Z 85 II, Z 87, Z 88	
RLMPU0360FCZZ	45021201 	Exposure Lamp 160V 250W	Z 85	
NROLT0799FCZZ	45636852 	Upper Fuser Roller DURACON™ II	Z 50, Z 52, Z 55, Z 70, Z 85	
CTME-0159FC01	45018040 	Upper Picker Finger	Z 50, Z 52, Z 55, Z 70, Z 85	<i>Priced per Picker Finger, sold in Boxes of 10.</i>

















Parts for use in Sharp Z 60

DWIR-0466CSZZ	45375548 	Corona Wire Spool 50 m / Spool 70μ Oxidized All Applications	Z 60	
---------------	---	---	------	--

For use in
Sharp
Copiers













Central/Eastern Europe
Telephone: 31(0)183-696969
Fax: 31(0)183-629055
E-mail: order@edc.katun.com

OEM PN	KATUN PN	DESCRIPTION	MODEL NO.	
Parts for use in Sharp Z 60				
NBRGC0136FCZZ	45016755 	Sintered Bronze Bushing	Z 60	<i>Priced per Bushing, sold in Packages of 10.</i>
NBRGC0140FCZZ	45016756 	Sintered Bronze Bushing	Z 60	<i>Priced per Bushing, sold in Packages of 10.</i>
PRNGP0013FCZZ	45011640 	V Ring	Z 60	<i>Priced per Seal, sold in Bags of 4.</i>
PRNGP0015FCZZ	45012311 	V Ring	Z 60	<i>Priced per Bag, 4 Seals per Bag.</i>
Parts for use in Sharp Z 810, Z 830, Z 845				
DWIR-0466CSZZ	45375548 	Corona Wire Spool 50 m / Spool 70µ Oxidized Transfer, Separation	Z 810, Z 830, Z 845	
MSPRT0513FCZZ	45524654 	Corona Wire Spring Stainless Steel Various Applications	Z 810, Z 830, Z 845	<i>Priced per Spring, sold in Bags of 10.</i>
NROLR1124FCZZ	45015960 	Lower Pressure Roller	Z 810, Z 830, Z 845	
NROLR0922FCZZ	45016478 	Manual Paper Feed Roller	Z 810, Z 830, Z 845	
CGUMM0286FC31	45009690 	Manual Paper Feed Tire Tire Only	Z 810, Z 830, Z 845	<i>Priced per Tire, sold in Bags of 10.</i>
CGUMM0288FC31	45014266 	Manual Paper Pickup Tire Tire Only	Z 810, Z 830, Z 845	<i>Priced per Tire, sold in Bags of 10.</i>
NROLI1140FCZZ	45015641 	Upper Fuser Roller OEM Type	Z 810, Z 830, Z 845	
NBRGP0567FCZZ	45020088 	Upper Fuser Roller Bushing	Z 810, Z 830	<i>Priced per Bushing, sold in Bags of 10.</i>
Parts for use in Sharp Document Feeder				
OJE07403008//	45576205 	Bearing Various Applications	AR- A 80, AR- A 81	
OJE07423808//	45576233 	Bearing Various Applications	AR- A 80, AR- A 81	
OCW2160P344//	45576233 	Bearing	AR- AF 1, AR- RF 1	





OEM PN	KATUN PN	DESCRIPTION	MODEL NO.	
Parts for use in Sharp Document Feeder				
0CW2160P344A/	45576233 	Bearing Various Applications	SF- A 14, SF- A 15, SF- A 54, SF- A 55, SF- A 57	
A3762096	45018496 	Belt Pressure Roller	AR- A 80	
NROLR1051FCZZ	45012886 	Manual Paper Feed Roller Tire Only	AR- RP 3, AR- SP 1, AR- SP 2, AR- SP 4	<i>Priced per Tire, sold in Bags of 10.</i>
NROLR0922FCZZ	45016478 	Manual Paper Feed Roller	AR- SP 3, AR- SP 5	
CGUMM0286FC31	45009690 	Manual Paper Feed Tire Tire Only	AR- SP 1, AR- SP 2, AR- SP 3	<i>Priced per Tire, sold in Bags of 10.</i>
CGUMM0288FC31	45014266 	Manual Paper Pickup Tire Tire Only	AR- SP 1, AR- SP 2, AR- SP 3	<i>Priced per Tire, sold in Bags of 10.</i>
OJEA3762196//	45018572 	Original Document Feed Belt	AR- A 80, AR- A 81	
0CW2166P352C/	45019644 	Original Document Feed Belt	SF- A 14	
0CW2199P364B/	45019644 	Original Document Feed Belt	SF- A 15	
0CW2168P355A/	45020057 	Original Document Feed Belt	SF- A 54, SF- A 55	
0CW2214P353//	45019289 	Original Document Feed Belt	AR- AF 1, AR- RF 1, SF- A 17, SF- A 56, SF- A 57, SF- A 58	
OJEA3761445//	45014409 	Original Feed Roller Tire Only	AR- A 80, AR- A 81	<i>Priced per Tire, sold in Bags of 10.</i>
0CW3023P072D/	45013137 	Original Feed Roller Tire Only	SF- A 12	<i>Priced per Tire, sold in Bags of 10.</i>
0CW2094P162A/	45636643 	Original Feed Roller Tire Only	SF- A 11, SF- A 51, SF- A 52	<i>Priced per Tire, sold in Bags of 10.</i>
0CW2158P366A/	45011370 	Original Feed Roller Tire Only	SF- A 54	<i>Priced per Tire, sold in Bags of 5.</i>
0CW2214P339//	45014070 	Original Feed Roller Tire Only	AR- AF 1, AR- RF 1, SF- A 17, SF- A 56	<i>Priced per Tire, sold in Bags of 4.</i>
0CW2198P331//	45011370 	Original Feed Roller H Tire Only	SF- A 55	<i>Priced per Tire, sold in Bags of 5.</i>

For use in
Sharp
Copiers

Central/Eastern Europe
Telephone: 31(0)183-696969
Fax: 31(0)183-629055
E-mail: order@edc.katun.com

OEM PN	KATUN PN	DESCRIPTION	MODEL NO.	
Parts for use in Sharp Document Feeder				
0CW2214P471//	45019943 	Original Pickup Roller Ribbed Tire For Document Feeder	AR- AF 1, AR- RF 1	<i>Priced per Pickup Roller, sold in Bags of 10.</i>
0CW2158P364A/	45019943 	Original Pickup Roller Ribbed Tire For Document Feeder	SF- A 17, SF- A 54, SF- A 55, SF- A 56	<i>Priced per Pickup Roller, sold in Bags of 10.</i>
0JEA6101485//	45017000 	Original Separation Belt	AR- A 81	
0CW2231K064//	45019944 	Original Separation Roller	AR- AF 1, AR- RF 1	
NROLR1312FCZZ	45022789 	Paper Pickup Roller	AR- EF 1	
NROLR0878FCZZ	45017032 	Paper Pickup Roller	SF- A 11, SF- A 51, SF- A 52	
NROLR0878FCZZ	45011076 	Paper Pickup Roller Tire Only	SF- A 11, SF- A 51, SF- A 52	<i>Priced per Tire, sold in Bags of 10.</i>
0CW2158P317A/	45013785 	Reverse Roller Tire Only	SF- A 54, SF- A 55	<i>Priced per Tire, sold in Bags of 10.</i>
0JEA3769502//	45011796 	Separation Belt	AR- A 80	<i>Priced per Package, 4 Belts per Package.</i>
0CW2199P421//	45014427 	Separation Belt Gray	SF- A 14, SF- A 15	
0CW2158P492A/	45014427 	Separation Belt Gray	SF- A 54	
0CW2198P320//	45014427 	Separation Belt Gray	SF- A 55	
NBRGC0136FCZZ	45016755 	Sintered Bronze Bushing	AR- EF 1	<i>Priced per Bushing, sold in Packages of 10.</i>

Parts for use in Sharp Paper Feed Unit

NROLR1218FCZZ	45018450 	Paper Feed Roller	AR- CS 1	
NROLR1049FCZ1	45016482 	Paper Feed Roller	SF- CM 16	
NROLR1049FCZ1	45012632 	Paper Feed Roller Tire Only	SF- CM 16	<i>Priced per Tire, sold in Bags of 10.</i>
PGUMM0012QSZZ	45022795 	Paper Feed Tire Green Tire For PN:CSFTZ0066RS71	AR- DE 5, AR- DE 6	<i>Priced per Tire, sold in Bags of 10.</i>















Katun Performance Product

© 2004 Katun Corporation

26 October 2004

For the most current product and pricing information, visit the Katun On-Line Catalog at www.katun.com.

Prices, terms and conditions are subject to change without notice.

OEM PN	KATUN PN	DESCRIPTION	MODEL NO.
Parts for use in Sharp Paper Feed Unit			
NROLR1219FCZZ	45018451 	Paper Pickup Roller	AR- CS 1
NROLR1219FCZZ	45021458 	Paper Pickup Roller Tire Only	AR- CS 1
			<i>Priced per Tire, sold in Bags of 10.</i>
NROLR1229FCZZ	45018452 	Reverse Roller	AR- CS 1
Parts for use in Sharp Pedestal			
N/P/N	45019752 	Feed Roller Replacement Kit New Style Kit Contains: • (1) Paper Feed Roller • (1) Paper Pickup Roller • (1) Reverse Roller	SF- D 20, SF- D 21, SF- D 23
N/P/N	45012325 	Feed Tire Replacement Kit Tire Only Old Style Kit Contains: • (1) Manual Pickup Tire • (2) Separation/Feed Tire	SF- D 21
CGUMM0288FC31	45014266 	Manual Paper Pickup Tire Tire Only	SF- D 22
			<i>Priced per Tire, sold in Bags of 10.</i>
NROLR1049FCZ1	45016482 	Paper Feed Roller	SF- D 14
NROLR1049FCZ1	45012632 	Paper Feed Roller Tire Only	SF- D 14
			<i>Priced per Tire, sold in Bags of 10.</i>
NROLR0986FCZZ	45020763 	Paper Feed Roller Tire Only For duplex unit only	SF- D 21
			<i>Priced per Tire, sold in Bags of 10.</i>
NROLR0986FCZZ	45011352 	Paper Feed Roller Tire Only	SF- D 21
			<i>Priced per Tire, sold in Bags of 10.</i>
NROLR0901FCZZ	45016481 	Paper Feed Roller	SF- D 21, SF- D 22
NROLR0901FCZZ	45011352 	Paper Feed Roller Tire Only	SF- D 21, SF- D 22
			<i>Priced per Tire, sold in Bags of 10.</i>
OCW4051P397//	45016761 	Paper Feed Roller Tire Only	SF- D 23
			<i>Priced per Tire, sold in Bags of 6.</i>

For use in
Sharp
Copiers

Central/Eastern Europe
Telephone: 31(0)183-696969
Fax: 31(0)183-629055
E-mail: order@edc.katun.com

OEM PN	KATUN PN	DESCRIPTION	MODEL NO.
Parts for use in Sharp Pedestal			
NROLR1049FCZZ	45016482	Paper Feed Roller	SF- D 20, SF- D 21, SF- D 23
NROLR1049FCZZ	45012632	Paper Feed Roller Tire Only	SF- D 20, SF- D 21, SF- D 23
NROLR1218FCZZ	45018450	Paper Feed Roller	AR- DE 1, SF- D 20, SF- D 21, SF- D 23
NROLR1311FCZZ	45022788	Paper Feed/Separation Roller	AR- D 13, AR- D 14
NROLR1312FCZZ	45022789	Paper Pickup Roller	AR- D 13, AR- D 14
NROLR0920FCZZ	45016480	Paper Pickup Roller	SF- D 20, SF- D 21
NROLR0920FCZZ	45011442	Paper Pickup Roller Tire Only Ribbed Tire	SF- D 20, SF- D 21
NROLR1114FCZZ	45014266	Paper Pickup Roller Tire Only	SF- D 22
NROLR1219FCZZ	45018451	Paper Pickup Roller	AR- DE 1, SF- D 20, SF- D 21, SF- D 23
NROLR1219FCZZ	45021458	Paper Pickup Roller Tire Only	AR- DE 1, SF- D 20, SF- D 21, SF- D 23
NROLR1229FCZZ	45018452	Reverse Roller	AR- DE 1, SF- D 20, SF- D 21, SF- D 23
NROLR0902FCZZ	45016479	Separation Roller	SF- D 20, SF- D 21
NROLR0902FCZZ	45011352	Separation Roller Tire Only	SF- D 20, SF- D 21
Parts for use in Sharp Cassette Module			
CROLP0015QS01	45023035	Paper Feed Roller Tire Only	AR- D 16, AR- DE 9
NROLR1311FCZZ	45022788	Paper Feed/Separation Roller	AR- MU 1
NROLR1312FCZZ	45022789	Paper Pickup Roller	AR- MU 1

*Priced per Tire,
sold in Bags of 10.*

*Priced per Tire,
sold in Bags of 10.*

*Priced per Tire,
sold in Bags of 10.*

*Priced per Tire,
sold in Bags of 10.*















*Priced per Tire,
sold in Bags of 10.*

*Priced per Tire,
sold in Bags of 4.*

OEM PN	KATUN PN	DESCRIPTION	MODEL NO.	
Parts for use in Sharp Duplex Unit				
NBRGY0466FCZZ	45576233 ◆	Bearing Various Applications	AR- DU 1	
NROLR0904FCZZ	45023073 ◆	Duplex Paper Pickup Roller	SF- DM 11	
NROLR0986FCZZ	45020763 ◆	Paper Feed Roller Tire Only For duplex unit only	SF- DM 11	<i>Priced per Tire, sold in Bags of 10.</i>
NROLR0986FCZZ	45011352 ◆	Paper Feed Roller Tire Only	SF- DM 11	<i>Priced per Tire, sold in Bags of 10.</i>
NROLR1312FCZZ	45022789 ◆	Paper Pickup Roller	AR- DU 4	
NROLR0909FCZZ	45016309 ◆	Separation Roller Tire Only	SF- DM 11	<i>Priced per Tire, sold in Bags of 10.</i>
CGUMM0287FC31	45016309 ◆	Separation Tire Tire Only	SF- DM 11	<i>Priced per Tire, sold in Bags of 10.</i>
NBRGC0136FCZZ	45016755 ◆	Sintered Bronze Bushing	AR- DU 1	<i>Priced per Bushing, sold in Packages of 10.</i>
Parts for use in Sharp Finisher				
NBRGY0466FCZZ	45576233 ◆	Bearing Various Applications	AR- FN 1, AR- FN 1 N, AR- FN 3, AR- FN 6	
NBRGY0131FCZZ	45576204 ◆	Bearing Various Applications	AR- FN 1, AR- FN 1 N, AR- FN 3, SD- F 200, SD- F 201	
Parts for use in Sharp Fax Module				
NROLR0922FCZZ	45016478 ◆	Manual Paper Feed Roller	AR- FX 3	
CGUMM0286FC31	45009690 ◆	Manual Paper Feed Tire Tire Only	AR- FX 3	<i>Priced per Tire, sold in Bags of 10.</i>
CGUMM0288FC31	45014266 ◆	Manual Paper Pickup Tire Tire Only	AR- FX 3	<i>Priced per Tire, sold in Bags of 10.</i>
Parts for use in Sharp Lct				
NBRGY0131FCZZ	45576204 ◆	Bearing Various Applications	AR- LC 1, AR- LC 1 N, AR- LC 2, AR- LC 2 N	
ON4408510800/	45576233 ◆	Bearing	AR- LC 4	

For use in
Sharp
Copiers

Central/Eastern Europe
Telephone: 31(0)183-696969
Fax: 31(0)183-629055
E-mail: order@edc.katun.com

OEM PN	KATUN PN	DESCRIPTION	MODEL NO.
Parts for use in Sharp Lct			
N/P/N	45019752 	Feed Roller Replacement Kit New Style Kit Contains: • (1) Paper Feed Roller • (1) Paper Pickup Roller • (1) Reverse Roller	SF- CM 11
N/P/N	45012325 	Feed Tire Replacement Kit Tire Only Old Style Kit Contains: • (1) Manual Pickup Tire • (2) Separation/Feed Tire	SF- CM 11
NROLR0901FCZZ	45016481 	Paper Feed Roller	SF- CM 11
NROLR0901FCZZ	45011352 	Paper Feed Roller Tire Only	SF- CM 11
NROLR0986FCZZ	45020763 	Paper Feed Roller Tire Only For duplex unit only	SF- CM 11
NROLR0986FCZZ	45011352 	Paper Feed Roller Tire Only	SF- CM 11
NROLR1049FCZZ	45016482 	Paper Feed Roller	AR- LC 1, AR- LC 1 N, AR- LC 2, AR- LC 2 N, SF- C 52, SF- CM 11
NROLR1049FCZZ	45012632 	Paper Feed Roller Tire Only	AR- LC 1, AR- LC 1 N, AR- LC 2, AR- LC 2 N, SF- C 52, SF- CM 11
NROLR1218FCZZ	45018450 	Paper Feed Roller	SF- CM 11
NROLR1049FCZ1	45016482 	Paper Feed Roller	SF- CM 14
NROLR1049FCZ1	45012632 	Paper Feed Roller Tire Only	SF- CM 14
NROLR1114FCZZ	45014266 	Paper Pickup Roller Tire Only	AR- LC 1, AR- LC 1 N, AR- LC 2, AR- LC 2 N
NROLR0920FCZZ	45016480 	Paper Pickup Roller	SF- C 52, SF- CM 11
NROLR0920FCZZ	45011442 	Paper Pickup Roller Tire Only Ribbed Tire	SF- C 52, SF- CM 11

*Priced per Tire,
sold in Bags of 10.*

*Priced per Tire,
sold in Bags of 10.*













*Priced per Tire,
sold in Bags of 10.*

*Priced per Tire,
sold in Bags of 10.*

*Priced per Tire,
sold in Bags of 10.*









*Priced per Tire,
sold in Bags of 10.*







*Priced per Tire,
sold in Bags of 10.*

OEM PN	KATUN PN	DESCRIPTION	MODEL NO.	
Parts for use in Sharp Lct				
NROLR1219FCZZ	45018451 	Paper Pickup Roller	SF- CM 11	
NROLR1219FCZZ	45021458 	Paper Pickup Roller Tire Only	SF- CM 11	<i>Priced per Tire, sold in Bags of 10.</i>
NROLR0878FCZZ	45017032 	Paper Pickup Roller	SF- CM 14	
NROLR0878FCZZ	45011076 	Paper Pickup Roller Tire Only	SF- CM 14	<i>Priced per Tire, sold in Bags of 10.</i>
NROLR1093FCZZ	45017034 	Reverse Roller	AR- LC 1, AR- LC 1 N, AR- LC 2, AR- LC 2 N, SF- C 52	
NROLR1093FCZZ	45011352 	Reverse Roller Tire Only	AR- LC 1, AR- LC 1 N, AR- LC 2, AR- LC 2 N, SF- C 52	<i>Priced per Tire, sold in Bags of 10.</i>
NROLR1229FCZZ	45018452 	Reverse Roller	SF- CM 11	
NROLR0902FCZZ	45016479 	Separation Roller	SF- CM 11	
NROLR0902FCZZ	45011352 	Separation Roller Tire Only	SF- CM 11	<i>Priced per Tire, sold in Bags of 10.</i>
Parts for use in Sharp Manual Feeder				
NROLR0922FCZZ	45016478 	Manual Paper Feed Roller	SF- MF 15	
CGUMM0286FC31	45009690 	Manual Paper Feed Tire Tire Only	SF- MF 15	<i>Priced per Tire, sold in Bags of 10.</i>
CROLP0921FC01	45017033 	Manual Pickup Roller	SF- MF 15	
CROLP0921FC01	45011442 	Manual Pickup Roller Tire Only Ribbed Tire	SF- MF 15	<i>Priced per Tire, sold in Bags of 10.</i>
Parts for use in Sharp Sorter				
OGZXG90013000	45576204 	Bearing Various Applications	SF- S 51, SF- S 53	

For use in
Sharp
Copiers







Central/Eastern Europe
Telephone: 31(0)183-696969
Fax: 31(0)183-629055
E-mail: order@edc.katun.com





OEM PN	KATUN PN	DESCRIPTION	MODEL NO.	
Kits				
N/P/N	45019844 	Drum Cartridge Rebuild Kit Kit Contains: • (1) OPC Drum • (1) Drum Cleaning Blade • (1) Drum Fixing Plate • (1) Cleaning Unit F/R Side Seals 12 OPC Kits per Master Carton	AL 1000, AL 1200, AR 120 E, AR 150, AR 150 E, AR 151, AR 156, AR F 151, AR F 152, DM 1500, DM 1505	<i>Priced per OPC Kit, sold per OPC Kit.</i>
N/P/N	45021362 	Black Toner Kit 225 g / Bottle Includes: • (1) Pour Spout 10 Bottles per Master Carton	AL 1000, AL 1200, AR 122 E, AR 122 E N, AR 122 EN, AR 123 E, AR 151, AR 152 E, AR 152 E N, AR 153 E, AR 153 E N, AR 156, AR 157 E, AR 157 E N, AR 162, AR 163, AR 201, AR 206, AR 207, AR F 152, AR F 201	<i>Priced per Carton, 10 Bottles per Carton.</i>
N/P/N	45018639 	OPC Drum Kit Kit Contains: • (1) OPC Drum • (1) Drum Fixing Plate 20 OPC Kits per Master Carton	AL 1000, AL 1200, DM 1500, DM 1505	<i>Priced per OPC Kit, sold per OPC Kit.</i>
AR-150CB	45020845 	Cleaning Blade Kit	AR 120 E, AR 150, AR 150 E, AR F 151	<i>Priced per Kit, 10 Blades per Kit.</i>
AR-150LR	45018639 	OPC Drum Kit Kit Contains: • (1) OPC Drum • (1) Drum Fixing Plate 20 OPC Kits per Master Carton	AR 120 E, AR 150, AR 150 E, AR F 151	<i>Priced per OPC Kit, sold per OPC Kit.</i>
AR-150LT	45021362 	Black Toner Kit 225 g / Bottle Includes: • (1) Pour Spout 10 Bottles per Master Carton	AR 120 E, AR 150, AR 150 E, AR F 151	<i>Priced per Carton, 10 Bottles per Carton.</i>
AR-152DM	45018639 	OPC Drum Kit Kit Contains: • (1) OPC Drum • (1) Drum Fixing Plate 20 OPC Kits per Master Carton	AR 121 E, AR 122 E, AR 122 E N, AR 122 EN, AR 123 E, AR 151, AR 152 E, AR 152 E N, AR 153 E, AR 153 E N, AR 156, AR 157 E, AR 157 E N, AR F 152	<i>Priced per OPC Kit, sold per OPC Kit.</i>
AR-152DR	45018639 	OPC Drum Kit Kit Contains: • (1) OPC Drum • (1) Drum Fixing Plate 20 OPC Kits per Master Carton	AR 122 E, AR 122 E N, AR 122 EN, AR 123 E, AR 151, AR 152 E, AR 152 E N, AR 153 E, AR 153 E N, AR 156, AR 157 E, AR 157 E N, AR 168 D, AR 168 S, AR F 152	<i>Priced per OPC Kit, sold per OPC Kit.</i>

OEM PN	KATUN PN	DESCRIPTION	MODEL NO.	
Kits				
AR-201DM	45017936 	OPC Drum Kit Kit Contains: <ul style="list-style-type: none"> • (1) OPC Drum • (1) Drum Fixing Plate 20 OPC Kits per Master Carton	AR 160, AR 161, AR 162, AR 163, AR 200, AR 200 S, AR 200 SE, AR 201, AR 205, AR 206, AR 207, AR F 201, DM 2000, DM 2005, DM 2010, DM 2015	<i>Priced per OPC Kit, sold per OPC Kit.</i>
AR-201DM	45023163	OPC Drum Kit Original	AR 160, AR 161, AR 162, AR 163, AR 200, AR 200 S, AR 200 SE, AR 201, AR 205, AR 206, AR 207, AR F 201, DM 2000, DM 2005, DM 2010, DM 2015	
AR-201DR	45017936 	OPC Drum Kit Kit Contains: <ul style="list-style-type: none"> • (1) OPC Drum • (1) Drum Fixing Plate 20 OPC Kits per Master Carton	AR 160, AR 161, AR 162, AR 163, AR 200, AR 200 S, AR 200 SE, AR 201, AR 205, AR 206, AR 207, AR F 201, DM 2000, DM 2005, DM 2010, DM 2015	<i>Priced per OPC Kit, sold per OPC Kit.</i>
N/P/N	45019524 	Drum Cartridge Rebuild Kit Kit Contains: <ul style="list-style-type: none"> • (1) OPC Drum • (1) Drum Cleaning Blade • (1) Drum Fixing Plate • (1) Cleaning Unit F/R Side Seals 12 OPC Kits per Master Carton	AR 160, AR 161, AR 162, AR 163, AR 200, AR 200 S, AR 200 SE, AR 201, AR 205, AR 206, AR 207, AR F 201, DM 2000, DM 2005, DM 2010, DM 2015	<i>Priced per OPC Kit, sold per OPC Kit.</i>
AR-200CB	45019531 	Cleaning Blade Kit Includes: Front & Rear Side Seals	AR 160, AR 161, AR 162, AR 163, AR 200, AR 200 S, AR 200 SE, AR 201, AR 205, AR 206, AR 207, DM 2000, DM 2005, DM 2010, DM 2015	<i>Priced per Kit, 10 Blades per Kit.</i>
AR-200LR	45017936 	OPC Drum Kit Kit Contains: <ul style="list-style-type: none"> • (1) OPC Drum • (1) Drum Fixing Plate 20 OPC Kits per Master Carton	AR 160, AR 161, AR 200, AR 200 S, AR 200 SE, AR 205	<i>Priced per OPC Kit, sold per OPC Kit.</i>
AR-200LT	45018441 	Black Toner Refill Kit 610 g / Bottle Includes: <ul style="list-style-type: none"> • (3) Pour Spout 10 Bottles per Master Carton	AR 160, AR 161, AR 200, AR 200 S, AR 200 SE, AR 205	<i>Priced per Carton, 10 Bottles per Carton.</i>
AR-200LT	45018155	Black Toner Refill Kit Original 610 g / Cartridge <ul style="list-style-type: none"> • (1) Waste Toner Bottle 	AR 160, AR 161, AR 200, AR 200 S, AR 200 SE, AR 205	<i>Priced per Cartridge, sold in Boxes of 10.</i>

For use in
Sharp
Copiers







Central/Eastern Europe
Telephone: 31(0)183-696969
Fax: 31(0)183-629055
E-mail: order@edc.katun.com







OEM PN	KATUN PN	DESCRIPTION	MODEL NO.
Kits			
N/P/N	45021825 	OPC Drum Kit Kit Contains: • (1) OPC Drum • (1) Drum Cleaning Blade 12 OPC Kits per Master Carton	AR 235, AR 275 <i>Priced per OPC Kit, sold per OPC Kit.</i>
AR-270CB	45020916 	Cleaning Blade Kit	AR 235, AR 275, AR M 208, AR M 236, AR M 237, AR M 276, AR M 277 <i>Priced per Kit, 10 Blades per Kit.</i>
AR-330KA	45018881 	80K PM Kit Kit Contains: • (1) Drum Cleaning Blade • (1) Charge Plate Assembly • (2) Drum Picker Finger • (2) Waste Toner Bottle • (4) Upper Picker Finger • (2) Lower Picker Finger • (1) Corona Screen Grid	AR 250, AR 280, AR 281, AR 285, AR 286, AR 287, AR 335, AR 336, AR 337
AR-330UH	45016918 	Upper Fuser Roller Kit Kit Contains: • (1) Upper Fuser Roller REVOLUTION™ • (1) Upper Fuser Roller Gear • (4) Upper Picker Finger	AR 250, AR 280, AR 281, AR 285, AR 286, AR 287, AR 335, AR 336, AR 337, AR 405, AR 407
AR-330CB	45020066 	Cleaning Blade Kit	AR 250, AR 280, AR 281, AR 285, AR 286, AR 287, AR 335, AR 336, AR 337, AR 405, AR 407, AR 501, AR 505, AR 507 <i>Priced per Kit, 10 Blades per Kit.</i>
N/P/N	45019752 	Feed Roller Replacement Kit New Style Kit Contains: • (1) Paper Feed Roller • (1) Paper Pickup Roller • (1) Reverse Roller	AR 250, AR 280, AR 281, AR 285, AR 286, AR 287, AR 335, AR 336, AR 337, AR 405, AR 407, AR 505, AR 507, AR C 150, SF 2022, SF 2022 N, SF 2027, SF 2027 N, SF 2030, SF 2035, SF 2040, SF 2530, SF 2540, SF- CM 11, SF- D 20, SF- D 21, SF- D 23
AR-330KB	45022595 	160K PM Kit Kit Contains: • (1) Upper Fuser Roller Gear • (1) Upper Fuser Roller • (1) Developer Unit Seal • (1) Lower Pressure Roller • (1) Toner Reception Seal	AR 250, AR 280, AR 281, AR 285, AR 286, AR 335, AR 336, AR 337, AR 405, AR 407

OEM PN	KATUN PN	DESCRIPTION	MODEL NO.
Kits			
AR-330LH	45017526 	Lower Pressure Roller Kit Kit Contains: <ul style="list-style-type: none"> • (1) Lower Pressure Roller MICROSLEEVE™ • (2) Lower Picker Finger 	AR 250, AR 280, AR 281, AR 285, AR 286, AR 335, AR 336, AR 405
AR-400KA	45018881 	90k PM KIT Kit Contains: <ul style="list-style-type: none"> • (1) Drum Cleaning Blade • (1) Charge Plate Assembly • (2) Drum Picker Finger • (2) Waste Toner Bottle • (4) Upper Picker Finger • (2) Lower Picker Finger • (1) Corona Screen Grid 	AR 250, AR 281, AR 286, AR 287, AR 336, AR 337, AR 405, AR 407
AR-400KB	45022596 	180K PM Kit Kit Contains: <ul style="list-style-type: none"> • (1) Upper Fuser Roller Gear • (1) Upper Fuser Roller • (1) Developer Unit Seal • (1) Lower Pressure Roller • (1) Toner Reception Seal 	AR 336, AR 405
AR-505KA	45022594 	125K Maintenance Kit Kit Contains: <ul style="list-style-type: none"> • (1) Charge Plate Assembly • (3) Waste Toner Bottle • (1) Drum Cleaning Blade • (2) Picker Finger • (1) Corona Screen Grid • (4) Upper Picker Finger • (2) Drum Picker Finger • (1) Thermistor Cleaning Roller 	AR 505, AR 507
N/P/N	45018868 	80K Maintenance Kit Kit Contains: <ul style="list-style-type: none"> • (1) Drum Cleaning Blade • (1) Lower Fuser Cleaning Roller • (2) Drum Picker Finger • (4) Upper Picker Finger • (1) Corona Screen Grid • (1) Upper Fuser Cleaning Roller • (4) Waste Toner Bottle • (2) Lower Picker Finger 	AR 5040, AR 5132

For use in
Sharp
Copiers







Central/Eastern Europe
Telephone: 31(0)183-696969
Fax: 31(0)183-629055
E-mail: order@edc.katun.com

OEM PN	KATUN PN	DESCRIPTION	MODEL NO.
Kits			
N/P/N	45014639 	Feed Tire Replacement Kit Tire Only Old Style Kit Contains: • (1) Paper Pickup Tire • (1) Paper Feed Tire • (1) Separation Tire	AR 5125, AR 5132, SF 2025, SF 2030, SF 2040
AR-C25UH	45023265 	Upper Fuser Roller Kit without Ball Bearings and Heat Sleeves Kit Contains: • (1) Upper Fuser Cleaning Roller • (1) Upper Fuser Roller	AR C 250
AR-202DM	45023163	OPC Drum Kit Original	AR M 160, AR M 205
SD-365UH	45016686 	Upper Fuser Roller Kit Kit Contains: • (1) Upper Fuser Roller ALUMANA™ • (4) Upper Picker Finger • (2) Heat Insulating Sleeve • (1) Upper Fuser Roller Gear	SD 2060, SD 2260, SD 2275, SD 3062
SD-360LH	45011615 	Lower Pressure Roller Kit MICROSLEEVE™ PFA Sleeve extends life. Kit Contains: • (1) Lower Pressure Roller • (4) Lower Picker Finger	SD 2060, SD 2260, SD 3062
SD-365KB	45014852 	250K PM Kit Kit Contains: • (1) Charge Plate • (1) Cleaning Unit Lower Seal • (2) Drum Picker Finger • (1) Corona Screen Grid • (1) Cleaning Unit Rear Side Seal • (1) Cleaning Unit Front Side Seal	SD 2060, SD 2260, SD 3062
SD-360KA	45014406 	125K Maintenance Kit Kit Contains: • (1) Upper Fuser Cleaning Roller Assembly • (1) Lower Fuser Cleaning Roller Assembly • (1) Drum Cleaning Blade • (1) Waste Toner Bottle	SD 2060, SD 3062







OEM PN	KATUN PN	DESCRIPTION	MODEL NO.	
Kits				
N/P/N	45013264 	Manual Feed Replacement Kit Tire Only Kit Contains: • (2) Manual Pickup Tire • (2) Manual Reverse Tire • (2) Manual Feed Tire	SD 2060, SD 3062	
SD-365KA	45014554 	125K PM Kit Kit Contains: • (1) Lower Fuser Cleaning Roller Assembly • (1) Drum Cleaning Blade • (1) Waste Toner Bottle • (1) Upper Fuser Cleaning Roller Assembly	SD 2260	
SF-216DM	45015434 	OPC Drum Kit Kit Contains: • (1) OPC Drum • (1) Drum Cleaning Blade • (2) Drum Picker Finger • (2) Drum Picker Finger Spring 12 OPC Kits per Master Carton	SF 1016, SF 1018, SF 1020, SF 1120, SF 2020, SF 2116, SF 2118, SF 2120	<i>Priced per OPC Kit, sold per OPC Kit.</i>
SF-216LH	45014025 	Lower Pressure Roller Kit Kit Contains: • (1) Lower Pressure Roller MICROSLEEVE™ • (2) Lower Picker Finger	SF 1016, SF 1018, SF 1116, SF 2116, SF 2118, SF 2216, SF 2218	
SF-216UH	45015481 	Upper Fuser Roller Kit Kit Contains: • (1) Upper Fuser Roller Gear • (2) Roller Stopper • (1) Upper Fuser Roller DURACON™ II • (4) Upper Picker Finger • (1) Front Fuser Roller Bushing • (1) Rear Fuser Roller Bushing	SF 1020, SF 1116, SF 1120, SF 2020, SF 2116, SF 2118, SF 2120, SF 2216, SF 2218, SF 2220, SF 2320	
SF-220LH	45015435 	Lower Pressure Roller Kit Kit Contains: • (1) Lower Pressure Roller MICROSLEEVE™ • (4) Lower Picker Finger	SF 1020, SF 1120, SF 2020, SF 2120, SF 2216, SF 2218, SF 2220, SF 2320	

For use in
Sharp
Copiers

Central/Eastern Europe
Telephone: 31(0)183-696969
Fax: 31(0)183-629055
E-mail: order@edc.katun.com







OEM PN	KATUN PN	DESCRIPTION	MODEL NO.	
Kits				
SF-222KA	45014403 	80K Maintenance Kit Kit Contains: <ul style="list-style-type: none"> • (1) Charge Plate • (2) Drum Picker Finger • (2) Lower Picker Finger • (4) Upper Picker Finger • (1) Upper Fuser Cleaning Roller Assembly • (1) Drum Cleaning Blade • (4) Waste Toner Bottle • (1) Corona Screen Grid 	SF 1025, SF 2022, SF 2022 N, SF 2027, SF 2027 N	
SF-222KB	45016193 	160K Maintenance Kit Kit Contains: <ul style="list-style-type: none"> • (1) Lower Pressure Roller • (1) Upper Fuser Roller Gear • (1) Upper Fuser Roller • (1) Toner Seal • (1) Developer Unit Seal 	SF 1025, SF 2022, SF 2022 N, SF 2027, SF 2027 N	
N/P/N	45012816 	Upper Fuser Roller Bearing Kit Kit Contains: <ul style="list-style-type: none"> • (2) Heat Insulating Sleeve • (2) Upper Fuser Roller Bearing Kit 	SF 1025, SF 2022, SF 2022 N, SF 2027, SF 2027 N, SF 2035, SF 2050, SF 7300, SF 7320, SF 7350, SF 7370, SF 7900, SF 8300, SF 8350, SF 8400, SF 8500, SF 8570, SF 8800, SF 8870	
N/P/N	45012325 	Feed Tire Replacement Kit Tire Only Old Style Kit Contains: <ul style="list-style-type: none"> • (1) Manual Pickup Tire • (2) Separation/Feed Tire 	SF 1025, SF 2022, SF 2022 N, SF 2027, SF 2027 N, SF 2035, SF- CM 11, SF- D 21	
SF-226DM	45016430 	OPC Drum Kit Kit Contains: <ul style="list-style-type: none"> • (1) OPC Drum • (1) Drum Cleaning Blade • (2) Drum Picker Finger 12 OPC Kits per Master Carton	SF 1116, SF 2216, SF 2218, SF 2220, SF 2320	<i>Priced per OPC Kit, sold per OPC Kit.</i>
SF-214DK2	45012543 	OPC Drum Kit Kit Contains: <ul style="list-style-type: none"> • (1) OPC Drum • (1) Drum Cleaning Blade • (3) Screw 12 OPC Kits per Master Carton	SF 2014, SF 2114, SF 2214	<i>Priced per OPC Kit, sold per OPC Kit.</i>









OEM PN	KATUN PN	DESCRIPTION	MODEL NO.
Kits			
SF-214HR	45015480 	Fuser Roller Kit Kit Contains: <ul style="list-style-type: none"> • (1) Lower Pressure Roller • (1) Upper Fuser Roller DURACON™ II • (4) Lower Picker Finger • (1) Upper Fuser Roller Gear • (2) Roller Stopper • (3) Upper Picker Finger • (1) Front Fuser Roller Bushing • (1) Rear Fuser Roller Bushing 	SF 2014, SF 2114, SF 2214, SF 2314, SF 2414, SF 2514
SF-240KA	45014407 	80K Maintenance Kit Kit Contains: <ul style="list-style-type: none"> • (1) Charge Plate • (2) Drum Picker Finger • (2) Lower Picker Finger • (4) Upper Picker Finger • (1) Upper Fuser Cleaning Roller Assembly • (1) Drum Cleaning Blade • (1) Lower Fuser Cleaning Roller • (4) Waste Toner Bottle • (1) Corona Screen Grid 	SF 2025, SF 2030, SF 2040
SF-340UH	45013612 	Upper Fuser Roller Kit Kit Contains: <ul style="list-style-type: none"> • (1) Upper Fuser Roller ALUMANA™ • (1) Upper Fuser Roller Gear • (4) Upper Picker Finger 	SF 2025, SF 2030, SF 2040
SF-240LH	45014024 	Lower Pressure Roller Kit Kit Contains: <ul style="list-style-type: none"> • (1) Lower Pressure Roller MICROSLEEVE™ • (2) Lower Picker Finger 	SF 2025, SF 2030, SF 2040, SF 2530, SF 2540
SF-330UH	45013612 	Upper Fuser Roller Kit Kit Contains: <ul style="list-style-type: none"> • (1) Upper Fuser Roller ALUMANA™ • (1) Upper Fuser Roller Gear • (4) Upper Picker Finger 	SF 2025, SF 2030, SF 2040, SF 2530, SF 2540
SF-330KB	45014529 	160K Maintenance Kit Kit Contains: <ul style="list-style-type: none"> • (1) Toner Holding Cleaner Unit • (1) Upper Fuser Roller Gear • (1) Lower Pressure Roller • (1) Upper Fuser Roller • (1) Developer Unit Seal 	SF 2025, SF 2030, SF 2530

For use in
Sharp
Copiers

Central/Eastern Europe
Telephone: 31(0)183-696969
Fax: 31(0)183-629055
E-mail: order@edc.katun.com





OEM PN	KATUN PN	DESCRIPTION	MODEL NO.
Kits			
SF-235KA	45014404 	80K Maintenance Kit Kit Contains: <ul style="list-style-type: none"> • (2) Drum Picker Finger • (1) Upper Fuser Cleaning Roller • (1) Lower Fuser Cleaning Roller • (1) Drum Cleaning Blade • (4) Upper Picker Finger • (2) Lower Picker Finger • (1) Charge Plate • (4) Waste Toner Bottle • (1) Corona Screen Grid 	SF 2035
SF-235KB	45016194 	160K Maintenance Kit Kit Contains: <ul style="list-style-type: none"> • (1) Toner Holding Cleaner Unit • (1) Upper Fuser Roller Gear • (1) Developer Unit Seal • (1) Upper Fuser Roller ALUMANA™ • (1) Lower Pressure Roller 	SF 2035
SF-235LH	45014024 	Lower Pressure Roller Kit Kit Contains: <ul style="list-style-type: none"> • (1) Lower Pressure Roller MICROSLEEVE™ • (2) Lower Picker Finger 	SF 2035
SF-235UH	45013613 	Upper Fuser Roller Kit Kit Contains: <ul style="list-style-type: none"> • (1) Upper Fuser Roller ALUMANA™ • (1) Upper Fuser Roller Gear • (4) Upper Picker Finger 	SF 2035
A3SF240KB	45014530 	160K Maintenance Kit Kit Contains: <ul style="list-style-type: none"> • (1) Toner Holding Cleaner Unit • (1) Upper Fuser Roller Gear • (1) Lower Pressure Roller • (1) Upper Fuser Roller • (1) Developer Unit Seal 	SF 2040
SF-340KB	45014530 	160K Maintenance Kit Kit Contains: <ul style="list-style-type: none"> • (1) Toner Holding Cleaner Unit • (1) Upper Fuser Roller Gear • (1) Lower Pressure Roller • (1) Upper Fuser Roller • (1) Developer Unit Seal 	SF 2040, SF 2540







OEM PN	KATUN PN	DESCRIPTION	MODEL NO.
Kits			
SF-250UH	45014196 	Upper Fuser Roller Kit Kit Contains: <ul style="list-style-type: none"> • (1) Upper Fuser Roller ALUMANA™ • (4) Upper Picker Finger • (1) Upper Fuser Roller Gear 	SF 2050
N/P/N	45015621 	Feed Tire Replacement Kit Tire Only Kit Contains: <ul style="list-style-type: none"> • (1) Paper Pickup Tire • (1) Paper Feed Tire • (1) Separation Tire 	SF 2050
SF-250KA	45014405 	100K Maintenance Kit Kit Contains: <ul style="list-style-type: none"> • (1) Upper Fuser Cleaning Roller Assembly • (1) Lower Fuser Cleaning Roller • (1) Drum Cleaning Blade • (1) Waste Toner Bottle 	SF 2050, SF 2052
SF-250KB	45013619 	200K Maintenance Kit Kit Contains: <ul style="list-style-type: none"> • (1) Charge Plate • (1) Developer Unit Front Side Seal • (1) Cleaning Unit Front Side Seal • (1) Cleaning Unit Rear Side Seal • (1) Developer Unit Rear Side Seal • (2) Drum Picker Finger • (1) Toner Holder Seal • (1) Corona Screen Grid 	SF 2050, SF 2052
SF-250LH	45014330 	Lower Pressure Roller Kit MICROSLEEVE™ PFA Sleeve extends life. Kit Contains: <ul style="list-style-type: none"> • (1) Lower Pressure Roller • (4) Lower Picker Finger 	SF 2050, SF 2052
SF-252UH	45016397 	Upper Fuser Roller Kit Kit Contains: <ul style="list-style-type: none"> • (1) Upper Fuser Roller ALUMANA™ • (2) Heat Insulating Sleeve • (1) Upper Fuser Roller Gear • (4) Upper Picker Finger 	SF 2050, SF 2052
SF-234DM	45016672 	OPC Drum Kit Kit Contains: <ul style="list-style-type: none"> • (1) OPC Drum • (1) Drum Cleaning Blade 12 OPC Kits per Master Carton	SF 2314, SF 2414, SF 2514

*Priced per OPC Kit,
 sold per OPC Kit.*

For use in
Sharp
Copiers

Central/Eastern Europe
Telephone: 31(0)183-696969
Fax: 31(0)183-629055
E-mail: order@edc.katun.com

OEM PN	KATUN PN	DESCRIPTION	MODEL NO.	
Kits				
SF-730DR	45503720 	OPC Drum Kit Kit Contains: • (1) OPC Drum • (1) Drum Cleaning Blade • (1) Separation Tape 12 OPC Kits per Master Carton	SF 7300, SF 7320, SF 7350, SF 7370	<i>Priced per OPC Kit, sold per OPC Kit.</i>
SF-730DR	45017767	OPC Drum Kit Access By Katun Kit Contains: • (1) OPC Drum • (1) Separation Tape • (1) Drum Cleaning Blade 12 Drums per Master Carton	SF 7300, SF 7320, SF 7350, SF 7370	<i>Priced per Drum, sold per Drum.</i>
SF-732HR	45014026 	Fuser Roller Kit Kit Contains: • (1) Upper Fuser Roller ALUMANA™ • (1) Lower Pressure Roller • (1) Fuser Cleaning Roller FIBRA™ II • (1) Upper Fuser Roller Gear • (3) Upper Picker Finger • (3) Roller Stopper • (2) Upper Fuser Roller Bearing • (2) Heat Insulating Sleeve	SF 7300, SF 7320, SF 7350, SF 7370	
N/P/N	45013248 	Paper Feed Roller Replacement Kit Tire Only Kit Contains: • (2) Paper Feed Tire A • (3) Paper Feed Tire B	SF 7300, SF 7320, SF 7350, SF 7370	
SF-770DR	45502779 	OPC Drum Kit Kit Contains: • (1) OPC Drum • (1) Drum Cleaning Blade 12 OPC Kits per Master Carton	SF 7700, SF 7750, SF 8100, SF 8260	<i>Priced per OPC Kit, sold per OPC Kit.</i>
SF-770DR <i>Final Inventory</i>	45013519	OPC Drum Kit Original Kit Contains: • (1) Drum Cleaning Blade • (1) OPC Drum	SF 7700, SF 7750, SF 8100, SF 8260	
SF-770DR	45009316	OPC Drum Kit Access By Katun Kit Contains: • (1) OPC Drum • (1) Drum Cleaning Blade 12 OPC Kits per Master Carton	SF 7700, SF 7750, SF 8100, SF 8260	<i>Priced per OPC Kit, sold per OPC Kit.</i>

OEM PN	KATUN PN	DESCRIPTION	MODEL NO.
Kits			
SF-780HR	45014098 	Fuser Roller Kit Kit Contains: <ul style="list-style-type: none"> • (1) Upper Fuser Roller DURACON™ II • (1) Lower Pressure Roller • (1) Lower Fuser Cleaning Roller Assembly • (2) Upper Fuser Roller Bushing • (1) Upper Fuser Roller Gear • (4) Upper Picker Finger • (5) Lower Picker Finger • (3) Roller Stopper • (1) Upper Fuser Cleaning Roller 	SF 7800, SF 7830, SF 7850
N/P/N	45010627 	OPC Drum Kit Kit Contains: <ul style="list-style-type: none"> • (1) OPC Drum • (1) Drum Cleaning Blade 12 Kits per Master Carton	SF 7800, SF 7830, SF 7850
N/P/N	45013143 	Feed Tire Replacement Kit Tire Only Kit Contains: <ul style="list-style-type: none"> • (2) Paper Feed Tire A • (2) Paper Feed Tire B 	SF 7800, SF 7830, SF 7850
SF-830KB <i>Final Inventory</i>	45011059 	120K Maintenance Kit Kit Contains: <ul style="list-style-type: none"> • (1) Upper Fuser Roller • (1) Lower Pressure Roller • (2) Lower Picker Finger • (1) Drum Cleaning Blade • (1) Toner Hold Plate Seal • (1) Developer Unit Lower Seal • (4) Upper Picker Finger 	SF 7900, SF 8300, SF 8350, SF 8400
SF-810RL	45021570 	Fuser Roller Cleaning Kit	SF 8100, SF 8260
N/P/N	45009116 	Convenience Kit Kit Contains: <ul style="list-style-type: none"> • (1) Upper Fuser Cleaning Roller • (1) Drum Cleaning Blade • (1) Lower Fuser Cleaning Roller 	SF 8500, SF 8800
N/P/N	45018577 	OPC Drum Kit Kit Contains: <ul style="list-style-type: none"> • (1) OPC Drum • (1) Drum Cleaning Blade 20 OPC Kits per Master Carton	Z 810, Z 830, Z 845

*Priced per Kit,
 sold per Kit.*























*Priced per OPC Kit,
 sold per OPC Kit.*

For use in
Sharp
Copiers

OEM Part Number Cross-Reference

In OEM part number order

Central/Eastern Europe
Telephone: 31(0)183-696969
Fax: 31(0)183-629055
E-mail: order@edc.katun.com

OEM PN	KATUN PN	DESCRIPTION
0CW2094P162A/	45636643	Original Feed Roller
		<i>Priced per Tire, sold in Bags of 10.</i>
0CW2148P095//	45011310	Original Feed Roller
		<i>Priced per Tire, sold in Bags of 10.</i>
0CW2148P095A/	45011310	Original Feed Roller
		<i>Priced per Tire, sold in Bags of 10.</i>
0CW2148P096//	45018143	Original Reverse Roller
		<i>Priced per Tire, sold in Bags of 10.</i>
0CW2148P096A/	45018143	Original Separation Roller
		<i>Priced per Tire, sold in Bags of 10.</i>
0CW2158P317A/	45013785	Reverse Roller
		<i>Priced per Tire, sold in Bags of 10.</i>
0CW2158P364A/	45019943	Original Pickup Roller
		<i>Priced per Pickup Roller, sold in Bags of 10.</i>
0CW2158P366A/	45011370	Original Feed Roller
		<i>Priced per Tire, sold in Bags of 5.</i>
0CW2158P492A/	45014427	Separation Belt
		
0CW2160P344//	45576233	Bearing
		
0CW2160P344A/	45576233	Bearing
		
0CW2166P352C/	45019644	Original Document Feed Belt
		
0CW2168P355A/	45020057	Original Document Feed Belt
		
0CW2176P382//	45011871	Original Document Feed Belt
		
0CW2176P382A/	45011871	Original Document Feed Belt
		
0CW2198P320//	45014427	Separation Belt
		
0CW2198P331//	45011370	Original Feed Roller H
		<i>Priced per Tire, sold in Bags of 5.</i>
0CW2199P364B/	45019644	Original Document Feed Belt
		
0CW2199P421//	45014427	Separation Belt
		
0CW2214P339//	45014070	Original Feed Roller
		<i>Priced per Tire, sold in Bags of 4.</i>
0CW2214P353//	45019289	Original Document Feed Belt
		
0CW2214P471//	45019943	Original Pickup Roller
		<i>Priced per Pickup Roller, sold in Bags of 10.</i>
0CW2214P575//	45019289	Original Document Feed Belt
		

OEM Part Number Cross-Reference

In OEM part number order

OEM PN	KATUN PN	DESCRIPTION
0CW2222P302//	45019945	Original Pickup Roller <i>Priced per Tire, sold in Bags of 10.</i>
0CW2231K064//	45019944	Original Separation Roller
0CW2254K073B/	45022962	Separation Pad
0CW2254P301//	45021614	Separation Roller <i>Priced per Tire, sold in Bags of 10.</i>
0CW2254P302//	45021896	Pickup Roller <i>Priced per Tire, sold in Bags of 10.</i>
0CW3023P072D/	45013137	Original Feed Roller <i>Priced per Tire, sold in Bags of 10.</i>
0CW4051P397//	45016761	Paper Feed Roller <i>Priced per Tire, sold in Bags of 6.</i>
0DJ43426601//	45247060	Upper Picker Finger <i>Priced per Picker Finger, sold in Packages of 10.</i>
0EUBLT0304D//	45016853	Original Document Feed Belt
0GZXG90013000	45576204	Bearing
0JE07403008//	45576205	Bearing
0JE07423808//	45576233	Bearing
0JE54472927//	45014401	Friction Pad B <i>Priced per Friction Pad, sold in Bags of 10.</i>
0JEA1093598//	45014609	Drum/Transfer Belt Cleaning Blade
0JEA3761445//	45014409	Original Feed Roller <i>Priced per Tire, sold in Bags of 10.</i>
0JEA3762196//	45018572	Original Document Feed Belt
0JEA3769502//	45011796	Separation Belt <i>Priced per Package, 4 Belts per Package.</i>
0JEA6101485//	45017000	Original Separation Belt
0JEA010018//	45019178	Upper Fuser Roller
0JEA020088//	45019179	Lower Pressure Roller
0JEA030015//	45576217	Upper Fuser Roller Bearing
0JEA030020//	45012106	Paper Pickup Roller <i>Priced per Tire, sold in Bags of 10.</i>
0JEA030021//	45632525	Paper Pickup Roller <i>Priced per Tire, sold in Bags of 10.</i>

For use in
Sharp
Copiers

OEM Part Number Cross-Reference

In OEM part number order

Central/Eastern Europe
Telephone: 31(0)183-696969
Fax: 31(0)183-629055
E-mail: order@edc.katun.com

OEM PN	KATUN PN	DESCRIPTION
0JEAFO31022//	45012104	Paper Feed Roller
		<i>Priced per Tire, sold in Bags of 10.</i>
0JEAFO32021//	45632523	Separation Roller
		<i>Priced per Tire, sold in Bags of 10.</i>
0JEAFO32023//	45012105	Separation Roller
		<i>Priced per Tire, sold in Bags of 10.</i>
OKS-33K02130/	45012699	Drum Cleaning Blade Assembly
		
ON4401762580/	45019951	Drum Picker Finger
		<i>Priced per Picker Finger, sold in Bags of 2.</i>
ON4401902550/	45576260	Heat Insulating Sleeve
		<i>Priced per Heat Sleeve, sold in Bags of 10.</i>
ON4407545610/	45576204	Bearing
		
ON4408510800/	45576233	Bearing
		
ON4409894220/	45019788	Drum Cleaning Blade
		
ON4409894260/	45018042	Oil Supply Roller
		
ON4409894280/	45018043	Lower Oil Supply Roller
		
ON6LA27028000	45023749	Upper Fuser Roller DURACON™ II
		
ON6LA27031000	45023549	Cleaning Web
		
ON6LA27060000	45023611	Lower Pressure Roller MICROSLEEVE™
		
41330 533800	45020088	Upper Fuser Roller Bushing
		<i>Priced per Bushing, sold in Bags of 10.</i>
41330 540600	45019610	Lower Pressure Roller
		
4409 893740	45018379	Lower Fuser Cleaning Roller
		
6LA58 639600	45019180	Drum Cleaning Blade
		
A2579550	45022278	Silicone Fuser Oil
		<i>Priced per Bottle, sold in Boxes of 6.</i>
A3762096	45018496	Belt Pressure Roller
		
A3SF116LT	45014477	Black Toner
		<i>Priced per Carton, 10 Bottles per Carton.</i>
A3SF240KB	45014530	160K Maintenance Kit
		
AL-100DR	45017931	OPC Drum Cartridge Original

OEM Part Number Cross-Reference

In OEM part number order





OEM PN	KATUN PN	DESCRIPTION
AL-100TD	45017930	Copier Toner Cartridge Original
AL-80TD	45018534	Black TD Cartridge Original
AR-150CB	45020845	Cleaning Blade Kit <i>Priced per Kit, 10 Blades per Kit.</i>
AR-150LR	45018639	OPC Drum Kit <i>Priced per OPC Kit, sold per OPC Kit.</i>
AR-150LT	45021362	Black Toner Kit <i>Priced per Carton, 10 Bottles per Carton.</i>
AR-152DM	45018639	OPC Drum Kit <i>Priced per OPC Kit, sold per OPC Kit.</i>
AR-152DR	45018639	OPC Drum Kit <i>Priced per OPC Kit, sold per OPC Kit.</i>
AR-152LD	45022037	Black Developer Original
AR-152LT	45022036	Black Toner Cartridge Original
AR-160UH	45018350	Upper Fuser Roller
AR-200CB	45019531	Cleaning Blade Kit <i>Priced per Kit, 10 Blades per Kit.</i>
AR-200DM	45018156	OPC Drum Cartridge Original
AR-200LR	45017936	OPC Drum Kit <i>Priced per OPC Kit, sold per OPC Kit.</i>
AR-200LT	45018441	Black Toner Refill Kit <i>Priced per Carton, 10 Bottles per Carton.</i>
AR-200LT	45018155	Black Toner Refill Kit Original <i>Priced per Cartridge, sold in Boxes of 10.</i>
AR-201DM	45017936	OPC Drum Kit <i>Priced per OPC Kit, sold per OPC Kit.</i>
AR-201DM	45023163	OPC Drum Kit Original
AR-201DR	45017936	OPC Drum Kit <i>Priced per OPC Kit, sold per OPC Kit.</i>
AR-201DV	45021588	Black Developer Original
AR-201FT	45023158	Black Toner Cartridge Original
AR-202CD	45021588	Black Developer Original
AR-202DM	45023163	OPC Drum Kit Original
AR-202ET	45023158	Black Toner Cartridge Original

For use in
Sharp
Copiers

OEM Part Number Cross-Reference

In OEM part number order

Central/Eastern Europe
Telephone: 31(0)183-696969
Fax: 31(0)183-629055
E-mail: order@edc.katun.com

OEM PN	KATUN PN	DESCRIPTION
AR-270CB	45020916	Cleaning Blade Kit
		<i>Priced per Kit, 10 Blades per Kit.</i>
AR-270DM	45021674	OPC Drum
		<i>Priced per Drum, sold per Drum.</i>
AR-271DM	45021674	OPC Drum
		<i>Priced per Drum, sold per Drum.</i>
AR-330BL	45018036	Drum Cleaning Blade
		
AR-330CB	45020066	Cleaning Blade Kit
		<i>Priced per Kit, 10 Blades per Kit.</i>
AR-330DM	45017933	OPC Drum
		<i>Priced per Drum, sold per Drum.</i>
AR-330HR	45018283	Lower Pressure Roller MICROSLEEVE™
		
AR-330HU	45016803	Upper Fuser Roller
		
AR-330JL	45018864	Ozone Filter
		
AR-330KA	45018881	80K PM Kit
		
AR-330KB	45022595	160K PM Kit
		
AR-330LH	45017526	Lower Pressure Roller Kit
		
AR-330LT	45017562	Black Toner
		<i>Priced per Carton, 10 Cartridges per Carton.</i>
AR-330LT	45018519	Black Toner
		<i>Priced per Cartridge, sold per Cartridge.</i>
AR-330TB	45017921	Waste Toner Bottle
		
AR-330TU	45018554	Corona Screen Grid
		
AR-330UH	45016918	Upper Fuser Roller Kit
		
AR-331DM	45017933	OPC Drum
		<i>Priced per Drum, sold per Drum.</i>
AR-336DM	45017933	OPC Drum
		<i>Priced per Drum, sold per Drum.</i>
AR-336LD	45017359	Black Developer Original
		
AR-400DM	45017801	OPC Drum
		<i>Priced per Drum, sold per Drum.</i>
AR-400HU	45016803	Upper Fuser Roller
		
AR-400KA	45018881	90k PM KIT
		

OEM Part Number Cross-Reference

In OEM part number order























OEM PN	KATUN PN	DESCRIPTION
AR-400KB	45022596	180K PM Kit
AR-400LT	45017562	Black Toner <i>Priced per Carton, 10 Cartridges per Carton.</i>
AR-400LT	45018519	Black Toner <i>Priced per Cartridge, sold per Cartridge.</i>
AR-450DR	45021676	OPC Drum <i>Priced per Drum, sold per Drum.</i>
AR-451DM	45021676	OPC Drum <i>Priced per Drum, sold per Drum.</i>
AR-500DM	45017935	OPC Drum <i>Priced per Drum, sold per Drum.</i>
AR-500LT	45018351	Black Toner <i>Priced per Carton, 10 Cartridges per Carton.</i>
AR-505HR	45018579	Lower Pressure Roller MICROSLEEVE™
AR-505HU	45018843	Upper Fuser Roller
AR-505KA	45022594	125K Maintenance Kit
AR-532DM	45017802	OPC Drum <i>Priced per Drum, sold per Drum.</i>
AR-532HU	45014437	Upper Fuser Roller ALUMANA™
AR-532LD1	45017683	Black Developer Original
AR-532LT1	45017681	Black Toner Original
AR-810DM	45023019	OPC Drum <i>Priced per Drum, sold per Drum.</i>
AR-C15SL	45021645	Fuser Oil <i>Priced per Bottle, sold in Boxes of 6.</i>
AR-C16DR	45023639	OPC Drum Black <i>Priced per Drum, sold per Drum.</i>
AR-C25UH	45023265	Upper Fuser Roller Kit
AX210037	45021484	Magnetic Clutch
B 8070 L	45018379	Lower Fuser Cleaning Roller
CBRGP0525FC02	45014520	Front Fuser Roller Bushing <i>Priced per Bushing, sold in Bags of 10.</i>
CBRGP0528FC02	45014521	Rear Fuser Roller Bushing <i>Priced per Bushing, sold in Bags of 10.</i>
CACLE-0076FC01	45001081	Drum Cleaning Blade

For use in
Sharp
Copiers

OEM Part Number Cross-Reference

In OEM part number order

Central/Eastern Europe
Telephone: 31(0)183-696969
Fax: 31(0)183-629055
E-mail: order@edc.katun.com

OEM PN	KATUN PN	DESCRIPTION
CCLEZ0117FC31	45010155	Drum Cleaning Blade
		
CCLEZ0117FC31	45022581	Drum Cleaning Blade Access By Katun
CCLEZ0125FC31	45011438	Drum Cleaning Blade
		
CCLEZ0126FC31	45012723	Toner Holding Cleaner Unit
		
CCLEZ0162FC31	45021875	Drum Cleaning Blade
		
CDAIU0451FC51	45020110	Drum Picker Finger Assembly
		
		<i>Priced per Picker Finger, sold in Packages of 2.</i>
CDAIU0451FC52	45020110	Drum Picker Finger Assembly
		
		<i>Priced per Picker Finger, sold in Packages of 2.</i>
CGUMM0286FC31	45009690	Manual Paper Feed Tire
		
		<i>Priced per Tire, sold in Bags of 10.</i>
CGUMM0287FC31	45016309	Separation Tire
		
		<i>Priced per Tire, sold in Bags of 10.</i>
CGUMM0288FC31	45014266	Manual Paper Pickup Tire
		
		<i>Priced per Tire, sold in Bags of 10.</i>
CGUMR0184FC31	45011087	Paper Feed Tire 500
		
		<i>Priced per Set, 4 Tires per Set.</i>
CPLTM2875FC31	45011153	Toner Seal Plate
		
Final Inventory		
CPLTM4129FC01	45011991	Charge Plate
		
CPLTZ4410FC02	45014390	Corona Screen Grid
		
CROLN0430FC33	45632511	Upper Fuser Cleaning Roller
		
CROLN0526FC31	45021380	Lower Fuser Cleaning Roller
		
CROLN0586FC31	45016812	Upper Fuser Cleaning Roller
		
CROLN0586FC33	45016811	Upper Fuser Cleaning Roller
		
CROLN0586FC34	45016812	Upper Fuser Cleaning Roller
		
CROLN0647FC01	45021398	Fuser Cleaning Roller FIBRA™ II
		
CROLN0647FC01	45635132	Fuser Cleaning Roller
		
CROLN0728FC32	45016812	Upper Fuser Cleaning Roller
		
CROLN0834FC01	45021395	Lower Fuser Cleaning Roller Assembly
		



Katun Performance Product

© 2004 Katun Corporation























26 October 2004

For the most current product and pricing information, visit the Katun On-Line Catalog at www.katun.com.

Prices, terms and conditions are subject to change without notice.

OEM Part Number Cross-Reference

In OEM part number order























OEM PN	KATUN PN	DESCRIPTION
CROLN0874FC31	45021424	Upper Fuser Cleaning Roller
		
CROLN0912FC31	45021394	Lower Fuser Cleaning Roller
		
CROLN0935FC31	45016768	Upper Fuser Cleaning Roller Assembly
		
CROLN0935FC33	45016856	Upper Fuser Cleaning Roller Assembly
		
CROLN0935FC35	45017938	Upper Fuser Cleaning Roller Assembly
		
CROLN0972FC32	45011169	Upper Fuser Cleaning Roller Assembly
		
CROLN0973FC31	45011170	Lower Fuser Cleaning Roller Assembly
		
CROLN1026FC33	45012580	Lower Fuser Cleaning Roller
		
CROLN1076FC32	45013290	Upper Fuser Cleaning Roller Assembly
		
CROLN1106FC31	45013063	Lower Fuser Cleaning Roller
		
CROLN1181FC31	45014818	Upper Fuser Cleaning Roller Assembly
		
CROLP0015QS01	45023035	Paper Feed Roller
		
		<i>Priced per Tire, sold in Bags of 4.</i>
CROLP0921FC01	45017033	Manual Pickup Roller
		
CROLP0921FC01	45011442	Manual Pickup Roller
		
		<i>Priced per Tire, sold in Bags of 10.</i>
CROLP1115FC01	45014266	Manual Pickup Roller
		
		<i>Priced per Tire, sold in Bags of 10.</i>
CROLR1048FC32	45013175	Reverse Roller Unit
		
		<i>Priced per Tire, sold in Bags of 10.</i>
CROLR1094FC32	45013175	Reverse Roller Unit
		
		<i>Priced per Tire, sold in Bags of 10.</i>
CSFTZ1771FC31	45011357	Manual Reverse Roller Assembly
		
		<i>Priced per Tire, sold in Bags of 10.</i>
CSFTZ2233FC31	45013175	Manual Reverse Roller Assembly
		
		<i>Priced per Tire, sold in Bags of 10.</i>
CSRA-0029FC31	45010160	Toner Hold Plate Seal
		
CTME-0159FC01	45018040	Upper Picker Finger
		
		<i>Priced per Picker Finger, sold in Boxes of 10.</i>
CYOK-0039FC01	45014388	Waste Toner Bottle
		
CYOK-0040FC03	45014432	Waste Toner Bottle
		

For use in
Sharp
Copiers

OEM Part Number Cross-Reference

In OEM part number order

Central/Eastern Europe
Telephone: 31(0)183-696969
Fax: 31(0)183-629055
E-mail: order@edc.katun.com

OEM PN	KATUN PN	DESCRIPTION	
CYOK-0049FC01	45014433	Waste Toner Bottle	
			
CYOK-0053FC01	45017921	Waste Toner Bottle	
			
DWIR-0466CSZZ	45375548	Corona Wire Spool	
			
DWIR-0467CSZZ	45375229	Corona Wire Spool	
			
DWIR-0522CSZZ	45375558	Corona Wire Spool	
			
DWIR-0550CSZZ	45375120	Corona Wire Spool	
			
LBSHC0228FCZZ	45012446	Heat Insulating Sleeve	<i>Priced per Heat Sleeve, sold in Bags of 10.</i>
			
LBSHC0334FCZZ	45014855	Heat Insulating Sleeve	<i>Priced per Set, 2 Heat Sleeves per Set.</i>
			
LBSHZ0178FCZ1	45014855	Heat Insulating Sleeve	<i>Priced per Set, 2 Heat Sleeves per Set.</i>
			
LBSHZ0330FCZZ	45012446	Heat Insulating Sleeve	<i>Priced per Heat Sleeve, sold in Bags of 10.</i>
			
LBSHZ0343FCZZ	45012446	Heat Insulating Sleeve	<i>Priced per Heat Sleeve, sold in Bags of 10.</i>
			
LPLTM2865FCZZ	45012561	Lower Picker Finger	<i>Priced per Picker Finger, sold in Bags of 5.</i>
Final Inventory			
LPLTM4387FCZZ	45016707	Corona Screen Grid	
Final Inventory			
LPLTM4746FCZZ	45012562	Lower Picker Finger	<i>Priced per Picker Finger, sold in Bags of 4.</i>
			
LPLTM5393FCZZ	45018554	Corona Screen Grid	
			
LPLTM5873FCZZ	45022696	Charge Corona Grid	
			
LPLTZ4069FCZZ	45013151	Corona Screen Grid	
			
LPLTZ4876FCZZ	45013154	Corona Screen Grid	
			
LPLTZ4952FCZZ	45016709	Corona Screen Grid	
			
LPLTZ5007FCZZ	45013153	Corona Screen Grid	
			
LPLTZ5474FCZZ	45013151	Corona Screen Grid	
			
MSPRT0513FCZZ	45524654	Corona Wire Spring	<i>Priced per Spring, sold in Bags of 10.</i>
			
NBRGC0136FCZ1	45016755	Sintered Bronze Bushing	<i>Priced per Bushing, sold in Packages of 10.</i>



Katun Performance Product

© 2004 Katun Corporation























26 October 2004

For the most current product and pricing information, visit the Katun On-Line Catalog at www.katun.com.

Prices, terms and conditions are subject to change without notice.

OEM Part Number Cross-Reference

In OEM part number order























OEM PN	KATUN PN	DESCRIPTION
NBRGC0136FCZZ	45016755	Sintered Bronze Bushing
		<i>Priced per Bushing, sold in Packages of 10.</i>
NBRGC0140FCZZ	45016756	Sintered Bronze Bushing
		<i>Priced per Bushing, sold in Packages of 10.</i>
NBRGC0200FCZZ	45576107	Lower Fuser Roller Bearing
		
NBRGP0146FCZZ	45576209	Upper Fuser Roller Bearing
		
NBRGP0416FCZZ	45013471	Upper Fuser Roller Bushing
Final Inventory		<i>Priced per Bushing, sold in Bags of 10.</i>
NBRGP0567FCZZ	45020088	Upper Fuser Roller Bushing
		<i>Priced per Bushing, sold in Bags of 10.</i>
NBRGP0573FCZZ	45576233	Bearing
		
NBRGY0022QSZZ	45015954	Lower Fuser Roller Bearing
		
NBRGY0093FCZZ	45576205	Bearing
		
NBRGY0131FCZZ	45576204	Bearing
		
NBRGY0199FCZZ	45021526	Upper Fuser Roller Bearing
		
NBRGY0213FCZZ	45576209	Upper Fuser Roller Bearing
		
NBRGY0215FCZZ	45021527	Upper Fuser Roller Bearing
		
NBRGY0232FCZZ	45016005	Lower Fuser Roller Bearing
		
NBRGY0253FCZZ	45576205	Lower Fuser Roller Bearing
		
NBRGY0255FCZZ	45021526	Upper Fuser Roller Bearing
		
NBRGY0285FCZZ	45576216	Upper Fuser Roller Bearing
		
NBRGY0295FCZZ	45576217	Upper Fuser Roller Bearing
		
NBRGY0296FCZZ	45013093	Lower Fuser Roller Bearing
		
NBRGY0325FCZZ	45576233	Bearing
		
NBRGY0466FCZZ	45576233	Bearing
		
NBRGY0479FCZZ	45015994	Upper Fuser Roller Bearing
		
NBRGY0487FCZZ	45016043	Lower Fuser Roller Bearing
		

For use in
Sharp
Copiers

OEM Part Number Cross-Reference

In OEM part number order

Central/Eastern Europe
Telephone: 31(0)183-696969
Fax: 31(0)183-629055
E-mail: order@edc.katun.com

OEM PN	KATUN PN	DESCRIPTION
NBRGY0551FCZZ	45576217	Upper Fuser Roller Bearing
		
NBRGY0599FCZZ	45576217	Bearing
		
NBRGY0646FCZZ	45021630	Upper Fuser Roller Bearing
		
NGERH0443FCZ1	45012819	Upper Fuser Roller Gear
		
NGERH0475FCZ1	45012825	Upper Fuser Roller Gear
		
NGERH0842FCZZ	45015022	Upper Fuser Roller Gear
		
NGERH1107FCZZ	45015022	Upper Fuser Roller Gear
		
NGERH1214FCZZ	45012819	Upper Fuser Roller Gear
		
NGERH1217FCZZ	45012825	Upper Fuser Roller Gear
		
NROLI0014QSZ2	45015641	Upper Fuser Roller
		
NROLI0014QSZ3	45015641	Upper Fuser Roller
		
NROLI0014QSZZ	45015641	Upper Fuser Roller
		
NROLI0030QSZZ	45018350	Upper Fuser Roller
		
NROLI0550FCZ1	45636366	Lower Pressure Roller
		
NROLI0583FCZZ	45013214	Lower Pressure Roller MICROSLEEVE™
		
NROLI0583FCZZ	45636769	Lower Pressure Roller
		
NROLI0594FCZ1	45636764	Lower Pressure Roller
		
NROLI0594FCZZ	45636764	Lower Pressure Roller
		
NROLI0836FCZZ	45636366	Lower Pressure Roller
		
NROLI0963FCZZ	45013214	Lower Pressure Roller MICROSLEEVE™
		
NROLI0963FCZZ	45636769	Lower Pressure Roller
		
NROLI0993FCZ1	45018874	Lower Pressure Roller MICROSLEEVE™
		
NROLI1028FCZZ	45012369	Lower Pressure Roller



Katun Performance Product

© 2004 Katun Corporation

26 October 2004

For the most current product and pricing information, visit the Katun On-Line Catalog at www.katun.com.

Prices, terms and conditions are subject to change without notice.

OEM Part Number Cross-Reference

In OEM part number order

OEM PN	KATUN PN	DESCRIPTION
NROLI1075FCZZ	45020950	Lower Pressure Roller MICROSLEEVE™
NROLI1103FCZZ	45013214	Lower Pressure Roller MICROSLEEVE™
NROLI1140FCZZ	45015641	Upper Fuser Roller
NROLI1206FCZZ	45018283	Lower Pressure Roller MICROSLEEVE™
NROLI1286FCZZ	45018579	Lower Pressure Roller MICROSLEEVE™
NROLI1314FCZZ	45022829	Lower Pressure Roller MICROSLEEVE™
NROLM1299FCZZ	45021728	Upper Fuser Roller
NROLM1300FCZZ	45021729	Lower Pressure Roller
NROLM1387FCZZ	45022662	Fuser Cleaning Roller
Final Inventory		
NROLN0587FCZZ	45021510	Lower Fuser Cleaning Roller
NROLN0874FCZZ	45021425	Thermistor Cleaning Roller
NROLN1249FCZZ	45021698	Upper Fuser Cleaning Roller
NROLP0648FCZZ	45013146	Paper Feed Roller
		<i>Priced per Tire, sold in Bags of 10.</i>
NROLR0028QSZZ	45019610	Lower Pressure Roller
NROLR0031QSZ1	45019860	Lower Pressure Roller MICROSLEEVE™
NROLR0031QSZZ	45018363	Lower Pressure Roller MICROSLEEVE™
NROLR0053QSZZ	45021697	Upper Fuser Roller
NROLR0083QSZZ	45021694	Lower Pressure Roller
NROLR0577FCZ1	45012755	Paper Feed Roller 250
		<i>Priced per Tire, sold in Bags of 4.</i>
NROLR0603FCZZ	45013136	Manual Paper Feed Roller
		<i>Priced per Tire, sold in Bags of 10.</i>
NROLR0878FCZ1	45016892	Paper Pickup Roller
		<i>Priced per Tire, sold in Bags of 10.</i>
NROLR0878FCZZ	45017032	Paper Pickup Roller
NROLR0878FCZZ	45011076	Paper Pickup Roller
		<i>Priced per Tire, sold in Bags of 10.</i>

For use in
Sharp
Copiers

OEM Part Number Cross-Reference























In OEM part number order

Central/Eastern Europe
Telephone: 31(0)183-696969
Fax: 31(0)183-629055
E-mail: order@edc.katun.com

OEM PN	KATUN PN	DESCRIPTION
NROLR0901FCZZ	45016481	Paper Feed Roller
NROLR0901FCZZ	45011352	Paper Feed Roller <i>Priced per Tire, sold in Bags of 10.</i>
NROLR0902FCZZ	45016479	Separation Roller
NROLR0902FCZZ	45011352	Separation Roller <i>Priced per Tire, sold in Bags of 10.</i>
NROLR0904FCZZ	45023073	Duplex Paper Pickup Roller
NROLR0909FCZZ	45016309	Separation Roller <i>Priced per Tire, sold in Bags of 10.</i>
NROLR0920FCZZ	45016480	Paper Pickup Roller
NROLR0920FCZZ	45011442	Paper Pickup Roller <i>Priced per Tire, sold in Bags of 10.</i>
NROLR0922FCZZ	45016478	Manual Paper Feed Roller
NROLR0955FCZZ	45016477	Manual Paper Feed Roller
NROLR0955FCZZ	45012756	Manual Paper Feed Roller <i>Priced per Tire, sold in Bags of 10.</i>
NROLR0956FCZZ	45017035	Paper Pickup Roller
NROLR0956FCZZ	45012782	Paper Pickup Roller <i>Priced per Tire, sold in Bags of 10.</i>
NROLR0964FCZZ	45017031	Manual Reverse Roller
NROLR0964FCZZ	45013017	Manual Reverse Roller <i>Priced per Tire, sold in Bags of 10.</i>
NROLR0986FCZZ	45020763	Paper Feed Roller <i>Priced per Tire, sold in Bags of 10.</i>
NROLR0986FCZZ	45011352	Paper Feed Roller <i>Priced per Tire, sold in Bags of 10.</i>
NROLR1049FCZ1	45016482	Paper Feed Roller
NROLR1049FCZ1	45012632	Paper Feed Roller <i>Priced per Tire, sold in Bags of 10.</i>
NROLR1049FCZZ	45016482	Paper Feed Roller
NROLR1049FCZZ	45012632	Paper Feed Roller <i>Priced per Tire, sold in Bags of 10.</i>
NROLR1051FCZZ	45012886	Manual Paper Feed Roller <i>Priced per Tire, sold in Bags of 10.</i>
NROLR1058FCZ3	45012885	Lower Pressure Roller MICROSLEEVE™

OEM Part Number Cross-Reference

In OEM part number order



















OEM PN	KATUN PN	DESCRIPTION
NROLR1088FCZZ	45013476	Duplex Paper Feed Roller
		<i>Priced per Tire, sold in Bags of 10.</i>
NROLR1093FCZZ	45017034	Reverse Roller
		
NROLR1093FCZZ	45011352	Reverse Roller
		<i>Priced per Tire, sold in Bags of 10.</i>
NROLR1096FCZZ	45012886	Manual Paper Feed Roller
		<i>Priced per Tire, sold in Bags of 10.</i>
NROLR1114FCZZ	45014266	Paper Pickup Roller
		<i>Priced per Tire, sold in Bags of 10.</i>
NROLR1124FCZZ	45015960	Lower Pressure Roller
		
NROLR1218FCZZ	45018450	Paper Feed Roller
		
NROLR1219FCZZ	45018451	Paper Pickup Roller
		
NROLR1219FCZZ	45021458	Paper Pickup Roller
		<i>Priced per Tire, sold in Bags of 10.</i>
NROLR1220FCZZ	45021479	Manual Reverse Roller
		<i>Priced per Tire, sold in Bags of 10.</i>
NROLR1229FCZZ	45018452	Reverse Roller
		
NROLR1240FCZZ	45021458	Manual Pickup Roller
		<i>Priced per Tire, sold in Bags of 10.</i>
NROLR1241FCZZ	45021483	Manual Paper Feed Roller
		<i>Priced per Tire, sold in Bags of 10.</i>
NROLR1285FCZZ	45021824	Curl Adjustment Roller
		
NROLR1311FCZZ	45022788	Paper Feed/Separation Roller
		
NROLR1312FCZZ	45022789	Paper Pickup Roller
		
NROLT0506FCZZ	45636367	Upper Fuser Roller
		
NROLT0549FCZZ	45636365	Upper Fuser Roller DURACON™ II
		
NROLT0582FCZZ	45013170	Upper Fuser Roller ALUMANA™
		
NROLT0593FCZZ	45013171	Upper Fuser Roller ALUMANA™
		
NROLT0593FCZZ	45014839	Upper Fuser Roller Access By Katun
		
NROLT0613FCZZ	45013170	Upper Fuser Roller ALUMANA™
		
NROLT0719FCZ1	45014437	Upper Fuser Roller ALUMANA™
		

For use in
Sharp
Copiers

OEM Part Number Cross-Reference

In OEM part number order

Central/Eastern Europe
Telephone: 31(0)183-696969
Fax: 31(0)183-629055
E-mail: order@edc.katun.com

OEM PN	KATUN PN	DESCRIPTION
NROLT0719FCZ1	45014840	Upper Fuser Roller Access By Katun
NROLT0799FCZZ	45636852 	Upper Fuser Roller DURACON™ II
NROLT0835FCZZ	45636365 	Upper Fuser Roller DURACON™ II
NROLT0867FCZZ	45013171 	Upper Fuser Roller ALUMANA™
NROLT0867FCZZ	45014839	Upper Fuser Roller Access By Katun
NROLT0913FCZ1	45014437 	Upper Fuser Roller ALUMANA™
NROLT0913FCZ1	45014840	Upper Fuser Roller Access By Katun
NROLT0962FCZZ	45014523 	Upper Fuser Roller ALUMANA™
NROLT0971FCZZ	45011313 	Upper Fuser Roller ALUMANA™
NROLT1031FCZZ	45012480 	Upper Fuser Roller DURACON™ II
NROLT1063FCZ2	45013027 	Upper Fuser Roller DURACON™ II
NROLT1063FCZZ	45013027 	Upper Fuser Roller DURACON™ II
NROLT1074FCZ1	45014112 	Upper Fuser Roller ALUMANA™
NROLT1074FCZ2	45014112 	Upper Fuser Roller ALUMANA™
NROLT1102FCZ1	45014437 	Upper Fuser Roller ALUMANA™
NROLT1102FCZ1	45014840	Upper Fuser Roller Access By Katun
NROLT1130FCZ2 <i>Final Inventory</i>	45016998 	Upper Fuser Roller
NROLT1183FCZZ	45011313 	Upper Fuser Roller ALUMANA™
NROLT1196FCZZ	45014437 	Upper Fuser Roller ALUMANA™
NROLT1277FCZZ	45016803 	Upper Fuser Roller
NROLT1280FCZZ	45014437 	Upper Fuser Roller ALUMANA™
NROLT1281FCZZ	45014437 	Upper Fuser Roller ALUMANA™
NROLT1283FCZZ	45018843 	Upper Fuser Roller



Katun Performance Product

© 2004 Katun Corporation























26 October 2004

For the most current product and pricing information, visit the Katun On-Line Catalog at www.katun.com.

Prices, terms and conditions are subject to change without notice.

OEM Part Number Cross-Reference

In OEM part number order























OEM PN	KATUN PN	DESCRIPTION
NROLT1313FCZZ	45022892	Upper Fuser Roller
		
NROLZ7051XCZZ	45016478	Paper Feed Roller
		
PFILZ0200FCZ1	45016652	Ozone Filter
<i>Final Inventory</i>		
PFILZ0201FCZ1	45016651	Ozone Filter
<i>Final Inventory</i>		
PFILZ0265FCZ1	45018864	Ozone Filter
		
PGUMM0012QSZZ	45022795	Paper Feed Tire
		
		<i>Priced per Tire, sold in Bags of 10.</i>
PGUMM0186FCZZ	45012877	Paper Feed Roller 500
		
		<i>Priced per Tire, sold in Bags of 8.</i>
PGUMM0187FCZZ	45013444	Paper Feed Roller 250
		
		<i>Priced per Tire, sold in Bags of 4.</i>
PGUMR0216FCZZ	45012703	Paper Feed Tire A
		
		<i>Priced per Tire, sold in Bags of 10.</i>
PGUMR0217FCZZ	45012481	Paper Feed Tire B
		
		<i>Priced per Tire, sold in Bags of 10.</i>
PGUMR0220FCZZ	45012748	Paper Feed Tire A
		
		<i>Priced per Tire, sold in Bags of 10.</i>
PGUMR0221FCZZ	45012773	Paper Feed Tire B
		
		<i>Priced per Tire, sold in Bags of 10.</i>
PGUMS0204FCZZ	45012481	Original Feed Roller
		
		<i>Priced per Tire, sold in Bags of 10.</i>
PRNGP0005GCZZ	45018026	V Ring
		
		<i>Priced per Seal, sold in Bags of 4.</i>
PRNGP0012FCZZ	45018027	V Ring
		
		<i>Priced per Seal, sold in Bags of 4.</i>
PRNGP0013FCZZ	45011640	V Ring
		
		<i>Priced per Seal, sold in Bags of 4.</i>
PRNGP0015FCZZ	45012311	V Ring
		
		<i>Priced per Bag, 4 Seals per Bag.</i>
PRNGP0050FCZZ	45012311	V Ring
		
		<i>Priced per Bag, 4 Seals per Bag.</i>
PRNGP0051FCZZ	45011640	V Ring
		
		<i>Priced per Seal, sold in Bags of 4.</i>
PRNGP0063FCZZ	45018027	V Ring
		
		<i>Priced per Seal, sold in Bags of 4.</i>
PRNGP0069FCZZ	45018026	V Ring
		
		<i>Priced per Seal, sold in Bags of 4.</i>
PRNGP0096FCZZ	45012311	V Ring
		
		<i>Priced per Bag, 4 Seals per Bag.</i>
PRNGP0097FCZZ	45011640	V Ring
		
		<i>Priced per Seal, sold in Bags of 4.</i>

For use in
Sharp
Copiers

OEM Part Number Cross-Reference

















In OEM part number order

Central/Eastern Europe
Telephone: 31(0)183-696969
Fax: 31(0)183-629055
E-mail: order@edc.katun.com

OEM PN	KATUN PN	DESCRIPTION
PRNGP0099FCZZ	45018027	V Ring
		<i>Priced per Seal, sold in Bags of 4.</i>
PSHEP4617FCZZ	45018032	Developer Unit Seal
		
PTME-0149FCZZ	45013096	Upper Picker Finger
		<i>Priced per Picker Finger, sold in Packages of 10.</i>
PTME-0168FCZZ	45013096	Upper Picker Finger
		<i>Priced per Picker Finger, sold in Packages of 10.</i>
PTME-0174FCZ1	45018041	Lower Picker Finger
		<i>Priced per Picker Finger, sold in Boxes of 10.</i>
PTME-0211FCZ1	45020110	Drum Picker Finger
		<i>Priced per Picker Finger, sold in Packages of 2.</i>
PTME-0226FCZZ	45012403	Upper Picker Finger
		<i>Priced per Picker Finger, sold in Packages of 4.</i>
PTME-0227FCZZ	45013791	Drum Picker Finger
		<i>Priced per Picker Finger, sold in Bags of 2.</i>
PTME-0244FCZZ	45013951	Lower Picker Finger
		<i>Priced per Picker Finger, sold in Bags of 2.</i>
PTME-0278FCZZ	45018645	Upper Picker Finger
		<i>Priced per Picker Finger, sold in Bags of 4.</i>
RDTCT0134FCZZ	45017285	Thermistor
		
RDTCT0135FCZZ	45017286	Thermistor
		
RLMPU0322FCZZ	45021182	Exposure Lamp
		
RLMPU0335FCZZ	45021184	Exposure Lamp
		
RLMPU0346FCZZ	45021113	Heater Lamp
		
RLMPU0355FCZZ	45021115	Heater Lamp
		
RLMPU0360FCZZ	45021201	Exposure Lamp
		
RLMPU0362FCZZ	45021182	Exposure Lamp
		
RLMPU0446FCZZ	45021086	Heater Lamp
		
RLMPU0474FCZZ	45011437	Exposure Lamp
<i>Final Inventory</i>		
RLMPU0489FCZZ	45021087	Heater Lamp
		
RLMPU0495FCZ1	45021123	Exposure Lamp
		
RLMPU0495FCZZ	45021123	Exposure Lamp

OEM Part Number Cross-Reference

In OEM part number order

OEM PN	KATUN PN	DESCRIPTION
RLMPU0516FCZZ	45021090	Heater Lamp
		
RLMPU0520FCZZ	45021144	Exposure Lamp
		
RLMPU0537FCZZ	45014726	Exposure Lamp
		
RLMPU0551FCZZ	45021096	Heater Lamp
		
RLMPU0574FCZZ	45021102	Heater Lamp
		
SD-360CB	45012610	Drum Cleaning Blade
		
		<i>Priced per Kit, 10 Blades per Kit.</i>
SD-360DV1	45013588	Black Developer Original
SD-360KA	45014406	125K Maintenance Kit
		
SD-360LD	45013588	Black Developer Original
SD-360LH	45011615	Lower Pressure Roller Kit MICROSLEEVE™
		
SD-360LT	45016904	Black Toner
		
		<i>Priced per Carton, 10 Cartridges per Carton.</i>
SD-360RL	45011170	Lower Fuser Cleaning Roller Assembly
		
SD-360RU	45011169	Upper Fuser Cleaning Roller Assembly
		
SD-360T	45013539	Black Toner Original
SD-365CD	45017356	Black Developer Original
SD-365DM	45015297	OPC Drum
		
		<i>Priced per Drum, sold per Drum.</i>
SD-365DV	45017356	Black Developer Original
SD-365KA	45014554	125K PM Kit
		
SD-365KB	45014852	250K PM Kit
		
SD-365LD	45017356	Black Developer Original
SD-365LT	45016904	Black Toner
		
		<i>Priced per Carton, 10 Cartridges per Carton.</i>
SD-365LT	45017355	Black Toner Original
SD-365RL	45011170	Lower Fuser Cleaning Roller Assembly
		

For use in
Sharp
Copiers

OEM Part Number Cross-Reference

In OEM part number order

Central/Eastern Europe
Telephone: 31(0)183-696969
Fax: 31(0)183-629055
E-mail: order@edc.katun.com

OEM PN	KATUN PN	DESCRIPTION
SD-365RU	45014818	Upper Fuser Cleaning Roller Assembly
SD-365SU	45014390	Corona Screen Grid
SD-365UH	45016686	Upper Fuser Roller Kit
SD-475HR	45021562	Lower Pressure Roller MICROSLEEVE™
SD-485UH	45016998	Upper Fuser Roller
<i>Final Inventory</i>		
SF- 76LT	45808181	Black Toner <i>Priced per Carton, 20 Bottles per Carton.</i>
SF-116T	45014477	Black Toner <i>Priced per Carton, 10 Bottles per Carton.</i>
SF-125LT	45014472	Black Toner <i>Priced per Carton, 10 Bottles per Carton.</i>
SF-126LT	45016681	Black Toner <i>Priced per Carton, 10 Bottles per Carton.</i>
SF-214DK2	45012543	OPC Drum Kit <i>Priced per OPC Kit, sold per OPC Kit.</i>
SF-214HR	45015480	Fuser Roller Kit
SF-214LT1	45021512	Black Toner <i>Priced per Carton, 10 Bottles per Carton.</i>
SF-214T1	45013543	Black Toner Original
SF-216DM	45015434	OPC Drum Kit <i>Priced per OPC Kit, sold per OPC Kit.</i>
SF-216DV1	45013586	Black Developer Original
SF-216HR	45012885	Lower Pressure Roller MICROSLEEVE™
SF-216HU	45013027	Upper Fuser Roller DURACON™ II
SF-216LD1	45013586	Black Developer Original
SF-216LH	45014025	Lower Pressure Roller Kit
SF-216LT1	45013249	Black Toner <i>Priced per Carton, 10 Cartridges per Carton.</i>
SF-216LT1	45013546	Black Toner Original
SF-216PU	45011991	Charge Plate
SF-216UH	45015481	Upper Fuser Roller Kit

OEM Part Number Cross-Reference

In OEM part number order

OEM PN	KATUN PN	DESCRIPTION
SF-220LH	45015435	Lower Pressure Roller Kit
SF-222BL	45010155	Drum Cleaning Blade
SF-222DM	45015845	OPC Drum <i>Priced per Drum, sold per Drum.</i>
SF-222DM	45015315	OPC Drum Access By Katun <i>Priced per Drum, sold per Drum.</i>
SF-222DV1	45013262	Black Developer <i>Priced per Bottle, sold per Bottle.</i>
SF-222DV1	45013572	Black Developer Original
SF-222KA	45014403	80K Maintenance Kit
SF-222KB	45016193	160K Maintenance Kit
SF-222LD1	45012962	Black Developer <i>Priced per Carton, 10 Bottles per Carton.</i>
SF-222LT1	45015363	Black Toner <i>Priced per Carton, 10 Cartridges per Carton.</i>
SF-222T1	45013461	Black Toner Original
SF-226DM	45016430	OPC Drum Kit <i>Priced per OPC Kit, sold per OPC Kit.</i>
SF-226DV	45016870	Black Developer Original
SF-226LT	45016681	Black Toner <i>Priced per Carton, 10 Bottles per Carton.</i>
SF-226LT	45018371	Black Toner <i>Priced per Carton, 10 Cartridges per Carton.</i>
SF-226LT	45016868	Black Toner Original
SF-226T	45019728	Black Toner <i>Priced per Cartridge, sold per Cartridge.</i>
SF-230DM	45014314	OPC Drum <i>Priced per Drum, sold per Drum.</i>
SF-230DM	45015374	OPC Drum Original
SF-230DV1	45018154	Black Developer Original
SF-230LT1	45013242	Black Toner <i>Priced per Carton, 10 Cartridges per Carton.</i>
SF-230T1	45015375	Black Toner Original
SF-234DM	45016672	OPC Drum Kit <i>Priced per OPC Kit, sold per OPC Kit.</i>

For use in
Sharp
Copiers

OEM Part Number Cross-Reference



















In OEM part number order

Central/Eastern Europe
Telephone: 31(0)183-696969
Fax: 31(0)183-629055
E-mail: order@edc.katun.com

OEM PN	KATUN PN	DESCRIPTION
SF-234DV	45016866	Black Developer Original
SF-234LT	45017246	Black Toner <i>Priced per Carton, 10 Cartridges per Carton.</i>
SF-234LT	45016865	Black Toner Original
SF-235DM	45015846	OPC Drum <i>Priced per Drum, sold per Drum.</i>
SF-235DV1	45013573	Black Developer Original
SF-235KA	45014404	80K Maintenance Kit
SF-235KB	45016194	160K Maintenance Kit
SF-235LD1	45013573	Black Developer Original
SF-235LH	45014024	Lower Pressure Roller Kit
SF-235LT1	45015364	Black Toner <i>Priced per Carton, 10 Cartridges per Carton.</i>
SF-235LT1	45013542	Black Toner Original
SF-235RL	45021394	Lower Fuser Cleaning Roller
SF-235RU	45016811	Upper Fuser Cleaning Roller
SF-235UH	45013613	Upper Fuser Roller Kit
SF-240DM	45014315	OPC Drum <i>Priced per Drum, sold per Drum.</i>
SF-240DU	45012446	Heat Insulating Sleeve <i>Priced per Heat Sleeve, sold in Bags of 10.</i>
SF-240HR	45013214	Lower Pressure Roller MICROSLEEVE™
SF-240KA	45014407	80K Maintenance Kit
SF-240LH	45014024	Lower Pressure Roller Kit
SF-240LT1	45013242	Black Toner <i>Priced per Carton, 10 Cartridges per Carton.</i>
SF-240RU	45016856	Upper Fuser Cleaning Roller
SF-240ST1	45015373	Black Toner Original
SF-250DM	45012934	OPC Drum <i>Priced per Drum, sold per Drum.</i>

OEM Part Number Cross-Reference

In OEM part number order





















OEM PN	KATUN PN	DESCRIPTION
SF-250KA	45014405	100K Maintenance Kit
		
SF-250KB	45013619	200K Maintenance Kit
		
SF-250LH	45014330	Lower Pressure Roller Kit MICROSLEEVE™
		
SF-250RL	45013063	Lower Fuser Cleaning Roller
		
SF-250RU	45013290	Upper Fuser Cleaning Roller Assembly
		
SF-250UH	45014196	Upper Fuser Roller Kit
		
SF-252HU	45014112	Upper Fuser Roller ALUMANA™
		
SF-252UH	45016397	Upper Fuser Roller Kit
		
SF-252UR	45013984	Upper Fuser Cleaning Roller Assembly
		
		<i>Priced per Box, 10 Cleaning Rollers per Box.</i>
SF-330KB	45014529	160K Maintenance Kit
		
SF-330UH	45013612	Upper Fuser Roller Kit
		
SF-340KB	45014530	160K Maintenance Kit
		
SF-340UH	45013612	Upper Fuser Roller Kit
		
SF-730CT1	45021513	Black Toner
		
		<i>Priced per Carton, 10 Bottles per Carton.</i>
SF-730CT1	45013329	Black Toner Original
SF-730DR	45503720	OPC Drum Kit
		
		<i>Priced per OPC Kit, sold per OPC Kit.</i>
SF-730DR	45017767	OPC Drum Kit Access By Katun
		<i>Priced per Drum, sold per Drum.</i>
SF-730LD1	45013356	Black Developer Original
SF-732HR	45014026	Fuser Roller Kit
		
SF-770DR	45502779	OPC Drum Kit
		
		<i>Priced per OPC Kit, sold per OPC Kit.</i>
SF-770DR	45013519	OPC Drum Kit Original
Final Inventory		
SF-770DR	45009316	OPC Drum Kit Access By Katun
		<i>Priced per OPC Kit, sold per OPC Kit.</i>
SF-770DV1	45818137	Black Developer
		
		<i>Priced per Bottle, sold per Bottle.</i>

For use in
Sharp
Copiers

OEM Part Number Cross-Reference















In OEM part number order

Central/Eastern Europe
Telephone: 31(0)183-696969
Fax: 31(0)183-629055
E-mail: order@edc.katun.com

OEM PN	KATUN PN	DESCRIPTION
SF-770MT1	45807831	Black Toner
		<i>Priced per Carton, 10 Bottles per Carton.</i>
SF-771LD1	45817804	Black Developer
		<i>Priced per Carton, 10 Bottles per Carton.</i>
SF-780CT1	45011359	Black Toner
		<i>Priced per Carton, 10 Cartridges per Carton.</i>
SF-780DR	45000930	OPC Drum Cartridge
		
SF-780DR	45013518	OPC Drum Cartridge Original
SF-780HR	45014098	Fuser Roller Kit
		
SF-780LD1	45013571	Black Developer Original
SF-810RL	45021570	Fuser Roller Cleaning Kit
		
SF-811CT1	45807826	Black Toner
		<i>Priced per Carton, 10 Bottles per Carton.</i>
SF-830CT1	45009715	Black Toner
		<i>Priced per Carton, 10 Cartridges per Carton.</i>
SF-830DR	45502786	OPC Drum
		<i>Priced per Drum, sold per Drum.</i>
SF-830DV1	45012973	Black Developer
		<i>Priced per Bottle, sold per Bottle.</i>
SF-830KB	45011059	120K Maintenance Kit
<i>Final Inventory</i>		
SF-830LD1	45012858	Black Developer
		<i>Priced per Carton, 10 Bottles per Carton.</i>
SF-880CT1	45021514	Black Toner
		<i>Priced per Carton, 20 Bottles per Carton.</i>
SF-880CT1	45013350	Black Toner Original
SF-970BL	45001081	Drum Cleaning Blade
		
SF-970DR	45502753	As2Se3 Drum
		<i>Priced per Drum, sold per Drum.</i>
UCLE-0004QSZZ	45016510	Drum Cleaning Blade
		
UCLEZ0009QSZ1	45017810	Drum Cleaning Blade
		
UCLEZ0011QSZZ	45020915	Drum Cleaning Blade
		
UCLEZ0013QSZZ	45019180	Drum Cleaning Blade
		
UCLEZ0069FCZZ	45244553	Drum Cleaning Blade
		

OEM Part Number Cross-Reference

In OEM part number order

OEM PN	KATUN PN	DESCRIPTION
UCLEZ0078FCZ4	45243495	Drum Cleaning Blade
		
UCLEZ0078FCZ4	45022583	Drum Cleaning Blade Access By Katun
UCLEZ0080FCZ1	45000386	Drum Cleaning Blade
		
UCLEZ0080FCZ1	45022582	Drum Cleaning Blade Access By Katun
UCLEZ0085FCZZ	45011152	Drum Cleaning Blade
		
UCLEZ0099FCZZ	45243424	Drum Cleaning Blade
		
UCLEZ0108FCZ1	45000401	Drum Cleaning Blade
		
UCLEZ0108FCZ1	45022580	Drum Cleaning Blade Access By Katun
UCLEZ0118FCZZ	45013005	Toner Seal
		
UCLEZ0126FCZ1	45012723	Toner Holder Seal
		
UCLEZ0136FCZZ	45014743	Developer Unit Seal
		
UCLEZ0149FCZ1	45018036	Drum Cleaning Blade
		
UCLEZ0156FCZ2	45021493	Drum Cleaning Blade
		
UCLEZ0157FCZZ	45021639	Toner Seal Blade
		
UCLEZ0158FCZZ	45019959	Toner Reception Seal
		
ZT-20TD1	45013644	Black T/D Cartridge Original
ZT-30DC1	45013980	Black T/D Cartridge Original
<i>Final Inventory</i>		
ZT-50DC1	45013698	Black T/D Cartridge Original
ZT-81DR	45017374	OPC Drum Cartridge Original
ZT-81TD1	45017939	Black T/D Cartridge Original
N/P/N	45017665	Memory Upgrade Board- 32 MB
<i>Final Inventory</i>		
N/P/N	45017668	Memory Upgrade Board- 32 MB
		
N/P/N	45017667	Memory Upgrade Board- 16 MB
<i>Final Inventory</i>		

For use in
Sharp
Copiers

OEM Part Number Cross-Reference

In OEM part number order

Central/Eastern Europe
Telephone: 31(0)183-696969
Fax: 31(0)183-629055
E-mail: order@edc.katun.com

OEM PN	KATUN PN	DESCRIPTION
N/P/N	45021362	Black Toner Kit <i>Priced per Carton, 10 Bottles per Carton.</i>
N/P/N	45018868	80K Maintenance Kit
N/P/N	45015567	Black Toner <i>Priced per Carton, 10 Bottles per Carton.</i>
N/P/N	45015568	Black Developer <i>Priced per Carton, 10 Bottles per Carton.</i>
N/P/N	45018577	OPC Drum Kit <i>Priced per OPC Kit, sold per OPC Kit.</i>
N/P/N	45010627	OPC Drum Kit <i>Priced per Kit, sold per Kit.</i>
N/P/N	45019524	Drum Cartridge Rebuild Kit <i>Priced per OPC Kit, sold per OPC Kit.</i>
N/P/N	45375228	Corona Wire Spool
N/P/N	45009116	Convenience Kit
N/P/N	45019844	Drum Cartridge Rebuild Kit <i>Priced per OPC Kit, sold per OPC Kit.</i>
N/P/N	45021825	OPC Drum Kit <i>Priced per OPC Kit, sold per OPC Kit.</i>
N/P/N	45012768	OPC Drum <i>Priced per Drum, sold per Drum.</i>
N/P/N	45015980	OPC Drum <i>Priced per Drum, sold per Drum.</i>
N/P/N	45012816	Upper Fuser Roller Bearing Kit
N/P/N	45018639	OPC Drum Kit <i>Priced per OPC Kit, sold per OPC Kit.</i>
N/P/N	45019752	Feed Roller Replacement Kit
N/P/N	45019180	Drum Cleaning Blade
N/P/N	45013264	Manual Feed Replacement Kit
N/P/N	45013248	Paper Feed Roller Replacement Kit
N/P/N	45014639	Feed Tire Replacement Kit
N/P/N	45012325	Feed Tire Replacement Kit
N/P/N	45015621	Feed Tire Replacement Kit
N/P/N	45010078	Drum Cleaning Blade

General Information

Credit Terms and Ordering Information

Credit Terms

Standard credit terms are net-30-days from date of invoice. To open a net-30-day account, please contact the Katun Credit Department. Until your credit application is approved, orders will be shipped upon receipt of cash in advance or a confirmed, Sight Draft, or via C.O.D. (Nominal C.O.D. handling charges will apply.)

Katun offers a 3% cash-with-order (CWO) discount. Katun will calculate the 3% discount, promptly inform you of the total charges, and ship your order immediately upon receipt of your payment.

Place all orders with Katun (E.D.C.) B.V. via:

- Telephone: 31(0) 183–696969
- Fax: 31(0) 183–629055
- E-mail: order@edc.katun.com
- Address:

Katun (E.D.C.) B.V.
Edisonweg 44
4207 HG Gorinchem
The Netherlands

Reference Katun part numbers on all orders.

Prices are in Euro, EX WORKS Gorinchem, The Netherlands.

Katun business hours are from 8:30 to 17.00 hours.

Katun has a € 350 minimum order. A € 35 charge will be added to orders under the minimum.

Wire transfer funds to:

ABN–AMRO Bank
Daalsesingel 71
Postbus 2059
3500 GB Utrecht
The Netherlands
Account Number: 55 70 74 134
Swift I.D.: ABN ANL 2A
IBAN: NL51ABNA0557074134

General Shipping Information and Product Return Policies

Shipping and Handling

Katun can provide you with alternatives for shipping. We will attempt to select the most convenient and cost-effective carrier for you. However, if you have a preferred carrier, please inform your Katun Customer Service Representative.



Central/Eastern Europe

Telephone: 31(0)183-696969

Fax: 31(0)183-629055

E-mail: order@edc.katun.com

Hazardous material shipments will be billed accordingly. A nominal handling charge is incorporated into our shipping costs.

Product Return Policies

- Katun **must** preauthorize all returns. For return procedures and a return, contact the Customer Service Department at 31(0) 183–696969.
- Toner, toner cartridges, digital duplicator inks and masters, and thermal transfer ribbons with personalized labels cannot be returned to Katun for credit unless a valid warranty claim exists.
- Returns and refused shipments are subject to a minimum 10% restocking charge.
- With the exception of warranty claims, merchandise returned more than 90 days from the invoice date will not be accepted.
- Merchandise which has been written on, marked, relabeled, or placed in other than original Katun packaging will not be accepted.
- All warranty claims submitted to Katun *must* be accompanied by a completed Distributor Choice Warranty Claim Form (included in this catalog). Customers must indicate a warranty choice on the form:
 - (a) Technical Evaluation/ Replacement or technical Evaluation/ Credit: Ship the product and the completed form to:

Katun (E.D.C.) B.V.
Edisonweg 44
4207 HG
Gorinchem
The Netherlands
 - (b) Automatic Replacement: send the completed form to your customer service representative.



Allgemeine Hinweise

Zahlungsbedingungen und Bestellinformationen

Die übliche Zahlungsweise ist bar innerhalb von 30 Tagen ab Rechnungsdatum. Zur Eröffnung eines Kontos wenden Sie sich bitte an die Katun Kreditabteilung. Bis zur Gewährung Ihres Kredits erfolgt der Versand von Bestellungen bei Vorkasse oder bei Erhalt eines bestätigten, Sichtwechsel oder gegen Nachnahme (unter Berechnung einer geringen Nachnahmegebühr).

Katun gewährt 3 % Skonto für Barzahlung bei Bestellung. Katun wird den Skontobetrag errechnen, Ihnen den Gesamtbetrag mitteilen und Ihre Bestellung unverzüglich nach Erhalt Ihrer Zahlung zum Versand aufgeben.

Bitte richten Sie alle Bestellungen an Katun (E.D.C.) B.V. unter:

- **Telefon: 31 (0) 183–696969**
- **Fax: 31 (0) 183–629055**
- **E-mail: order@edc.katun.com**
- **Adresse:**

Katun (E.D.C.) B.V.
Edisonweg 44
NL-4207 HG Gorinchem
Niederlande

Bitte bei allen Bestellungen die Katun Artikelnummern angeben. Preise verstehen sich in Euro, ab Werk Gorinchem, Niederlande.

Katun Geschäftszeit ist 8.30 - 17.00 Uhr. Für alle Bestellungen gilt ein Mindestbestellwert von € 350. Bei Bestellungen unter dem Mindestbestellwert wird ein Zuschlag von €35 berechnet.

Bankverbindung:

ABN AMRO Bank
Daalsesingel 71
Postbus 2059
NL-3500 GB Utrecht
Niederlande
Kontonummer: 55 70 74 134
Bankleitzahl: ABN ANL 2A
IBAN: NL51ABNA0557074134

Versand und Warenrücksendung

Bearbeitung und Versand

Katun bietet verschiedene Versandmethoden an. Wir bemühen uns, die für Sie günstigste und praktischste Versandart zu wählen. Falls Sie eine bestimmte Versandart/Firma vorziehen, teilen Sie dies bitte Ihrem Katun Repräsentanten mit.

Central/Eastern Europe

Telephone: 31(0)183-696969

Fax: 31(0)183-629055

E-mail: order@edc.katun.com

Versandkosten für Gefahrgüter werden entsprechend berechnet. Eine geringe Bearbeitungsgebühr ist in unseren Versandgebühren enthalten.

Warenrücksendung

- Nur von Katun vorher genehmigte Waren- rücksendungen könnenbearbeitet werden. Bitte lassen Sie sich vom Kundendienst unter der Telefonnummer 31 (0) 183-696969 genaue Anweisungen geben.
- Bei Warenrücksendungen werden 10 % Rücknahmegebühren in Abzug gebracht.
- Toner, Drucker-/Faxkartuschen, Tinten für digitale Duplikatoren sowie Thermo-Transfer-Bänder mit Firmenetiketten sind vom Umtausch ausgeschlossen, es sei denn, es liegt ein Garantiefall for.
- Ware, die nach Ablauf von 90 Tagen ab Rechnungsdatum zurückgeschickt wird, kann nicht zurückgenommen werden (mit Ausnahme von Reklamationen).
- Ware, deren Verpackung markiert, etikettiert oder beschriftet wurde, oder Ware ohne Originalverpackung kann nicht zurückgenommen werden.
- Alle Garantieansprüche müssen von einem ausgefüllten Händler -Garantieformular begleitet sein (Formular in diesem Katalog enthaltrn). Geben Sie Ihren Regulierungswunsch auf dem Formular an:
 - (a) Technische Bewertung/Ersatz oder Technische Bewertung/Gutschrift: schicken Sie das Produkt und das vollständig ausgefüllte Formular an:

Katun (E.D.C.) B.V.
Edisonweg 44
NL-4207 HG Gorinchem
Niederlande
 - (b) Ersatz ohne Bewertung: schicken Sie das vollständig ausgefüllte Formular an Ihren Ansprechpartner der Auftragsbearbeitung.

DISTRIBUTOR CHOICE WARRANTY CLAIM FORM

Please print all information. For prompt processing of your claim, please complete all sections. Your feedback is important to the ongoing improvement of Katun products. Thank you.

I. WARRANTY CHOICE

Please check one. See Section 2 on reverse side for additional information.

Technical Evaluation/Replacement Technical Evaluation/Credit Automatic Replacement

II. CUSTOMER INFORMATION

Customer Number: _____ Date Shipped: _____

Company Name: _____ Delivery Date: _____

Address: _____

City: _____ State/Province: _____

Country: _____ Postal Code: _____

Your Name: _____ Title: _____

III. PRODUCT INFORMATION

Katun PN	Quantity	Description	Serial/Lot Number
1) _____	_____	_____	_____
2) _____	_____	_____	_____
3) _____	_____	_____	_____
4) _____	_____	_____	_____
5) _____	_____	_____	_____

IV. DETAILED REASON(S) FOR CLAIM

Provide specific information for each product claimed, explaining the reason for claim in as much detail as possible. Include machine models, machine log information, and copy/print counts. **See Section 3 on reverse side for additional specific requirements for photoreceptors.**

- 1) _____
- 2) _____
- 3) _____
- 4) _____
- 5) _____

FOR KATUN USE ONLY

Product Warranty Claim No.: _____ Pieces: _____
Received By: _____ Date: _____

Central/Eastern Europe

Telephone: 31(0)183-696969

Fax: 31(0)183-629055

E-mail: order@edc.katun.com

PLEASE READ AND COMPLY WITH ALL THESE REQUIREMENTS TO EXPEDITE THE PROCESSING OF YOUR CLAIM.

1. General Instructions

A completed copy of this form must accompany all product warranty claims. Please indicate date of product delivery for determination of warranty coverage time period. *Your feedback is important to the ongoing improvement of Katun products. Please complete all sections on the reverse side.*

2. Distributor Choice Warranty Claim Options

Please indicate your choice of Technical Evaluation/Replacement, Technical Evaluation/Credit, or Automatic Replacement. **NOTE:** Automatic Replacement claims must be filed within 90 days of product delivery date, and must not exceed US\$500/€ 550.

If no choice is indicated:

- (a) If product is included with this form, this claim will be treated as Technical Evaluation/Replacement.
- (b) If no product is included with this form, and the claim is less than US\$500/€ 550, this claim will be treated as Automatic Replacement.
- (c) If no product is included with this form, and the claim is more than US\$500/€ 550, the claim is invalid.

3. Specific Requirements

If damage (for example, a chip or scratch on a photoreceptor) is noted "out-of-box," DO NOT INSTALL THE PRODUCT. No copy/print samples are required. Installing a product with out-of-box damage could void the warranty.

Include applicable copy/print samples with all claims. If a photoreceptor is suspected to be defective after machine installation, please attach to this form the copy/print samples indicated below. This will allow a thorough evaluation of the claim. Ensure that neither the form nor copy/print samples will contact the photoreceptor surface during shipment.

FOR PHOTORECEPTORS USED IN COPIERS, include:

- (a) Three "sky shot" (open platen; black) copies;
- (b) Three white copies; and
- (c) Three copies of a test pattern.

NOTE: If the defect is not visible on the copies indicated above, please attach three copies which clearly show the defect.

FOR PHOTORECEPTORS USED IN PRINTERS AND PLAIN PAPER FACSIMILES, include three prints which clearly show the defect.

IMPORTANT: The Katun product warranty does not cover damage by operator, technician, or machine (including rotational scratches, gouges, scuff marks, or line scratches).

4. Shipping Instructions

ALL PRODUCT RETURNS MUST BE PROPERLY PACKAGED. This includes packaging in the correct individual product box and in a second container with adequate protective packaging material. This is required by all carriers.

NOTE: Products damaged in transit to Katun due to inadequate packaging cannot be covered by the Katun product warranty, and will be returned.

Ship Technical Evaluation claims, freight prepaid, to the address specifically indicated for this purpose in the "General Information" section of the Katun On-Line Catalogue and current printed catalogues. Katun cannot accept responsibility for product warranty claims sent to any other address. **Send Automatic Replacement Claims to your Katun Customer Service Representative.**

HÄNDLER-GARANTIEFORMULAR

Das Formular bitte in Druckschrift ausfüllen. Um eine umgehende Bearbeitung Ihrer Reklamation zu ermöglichen, tragen Sie bitte alle Angaben ein.

Ihr Feedback trägt zur weiteren Verbesserung von Katun-Produkten bei. Vielen Dank.

I. REGULIERUNGSWUNSCH

Bitte nur einen ankreuzen. Weitere Informationen finden Sie in Abschnitt 2 auf der Rückseite.

Technische Bewertung/Ersatz Technische Bewertung/Gutschrift Ersatz ohne Bewertung

II. KUNDENINFORMATIONEN

Kunden-Nr.: _____ Versanddatum: _____

Firmenname: _____ Lieferdatum: _____

Straße: _____

Postleitzahl: _____ Ort: _____

Land: _____

Ihr Name: _____ Titel/Funktion: _____

III. PRODUKTINFORMATIONEN

Katun-Artikel-Nr.	Menge	Bezeichnung	Serien-/Lotnummer
1) _____	_____	_____	_____
2) _____	_____	_____	_____
3) _____	_____	_____	_____
4) _____	_____	_____	_____
5) _____	_____	_____	_____

IV. AUS WELCHEM GRUND REKLAMIEREN SIE DIE WARE?

Machen Sie bitte zu jedem reklamierten Artikel so ausführliche und genaue Angaben wie möglich. Des weiteren benötigen wir Angaben zum Gerätemodell, eine Kopie des Bordbuches sowie Informationen bezüglich der Anzahl der erstellten Kopien/Ausdrucke des Produktes. **Bitte beachten Sie Punkt 3 auf der Rückseite mit wichtigen Informationen zur Reklamation von Fotorezeptoren.**

1) _____

2) _____

3) _____

4) _____

5) _____

NUR FÜR DEN INTERNEN GEBRAUCH

Reklamations-Nr.: _____ Stückzahl: _____

Entgegengenommen von: _____ Eingangsdatum: _____

Central/Eastern Europe

Telephone: 31(0)183-696969

Fax: 31(0)183-629055

E-mail: order@edc.katun.com

BITTE BEACHTEN SIE FOLGENDE HINWEISE, UM DIE BEARBEITUNG IHRER REKLAMATION ZU BESCHLEUNIGEN.

1. Allgemeine Hinweise

Verwenden Sie diesen Mängelbericht bei allen Reklamationen. Geben Sie zur Bestimmung der Garantiefrist bitte das Lieferdatum des Produktes an. *Ihr Feedback trägt zur weiteren Verbesserung von Katun-Produkten bei. Bitte tragen Sie alle Angaben auf der Rückseite vollständig ein.*

2. Händler-Garantieoption

Geben Sie bitte Ihren Regulierungswunsch an (Technische Bewertung/Ersatz, Technische Bewertung/Gutschrift oder Ersatz ohne Bewertung.) **BITTE BEACHTEN:** Reklamationen ohne Bewertung müssen innerhalb von 90 Tagen nach dem Lieferdatum des Produktes geltend gemacht werden und dürfen einen Wert von USD 500/Euro 550 nicht überschreiten.

Wenn keine Wahl getroffen wurde:

- (a) Wenn diesem Formular das Produkt beigelegt wurde, wird diese Reklamation als Technische Bewertung/Ersatz bearbeitet.
- (b) Wenn diesem Formular kein Produkt beigelegt wurde und der Wert der Reklamation weniger als USD 500/ Euro 550 beträgt, wird diese Reklamation als Ersatz ohne Bewertung bearbeitet.
- (c) Wenn diesem Formular kein Produkt beigelegt wurde und der Wert der Reklamation mehr als USD 500/ Euro 550 beträgt, besteht kein Anspruch auf Reklamation.

3. Spezielle Anforderungen

Wenn Schäden (z.B. Splitter oder Kratzer an einem Fotorezeptor) bereits „beim Auspacken“ festgestellt werden, dann **INSTALLIEREN SIE DAS PRODUKT NICHT.** Testkopien sind nicht erforderlich. Die Installation eines Produktes mit bereits bestehendem Schaden könnte zum Erlöschen Ihrer Garantieansprüche führen.

Fügen Sie allen Reklamationen entsprechende Testkopien bei. Wenn ein Fotorezeptor nach der Installation einen Defekt aufzuweisen scheint, legen Sie diesem Formular bitte die nachstehend beschriebenen Testkopien bei, um eine genaue Beurteilung der Mängel zu ermöglichen. Das Formular sowie die Testkopien dürfen bei der Rücksendung auf keinen Fall mit der Oberfläche des Fotorezeptors in Berührung kommen.

FÜR FOTOREZEPTOREN, DIE IN KOPIERERN BENUTZT WURDEN, folgende Testkopien beilegen:

- (a) 3 schwarze Kopien (bei offener Vorlagenglas-Abdeckung),
- (b) 3 weiße Kopien und
- (c) 3 Testkopien (vom Testbogen).

BITTE BEACHTEN: Ist der Defekt auf diesen Mustern nicht sichtbar, legen Sie bitte 3 Kopien bei, auf denen er deutlich zu erkennen ist.

FÜR FOTOREZEPTOREN, DIE IN DRUCKERN UND NORMALPAPIER-FAXGERÄTEN BENUTZT WURDEN, legen Sie bitte 3 Kopien bei, auf denen der Defekt deutlich zu erkennen ist.

WICHTIG: Schäden, die durch falsche Bedienung des Endanwenders, durch den Techniker oder das Gerät verursacht wurden (d. h. umlaufende Kratzer, Streifen, Abrieb oder querlaufende Kratzer), sind von der Katun Qualitätsgarantie ausgeschlossen.

4. Versandrichtlinien

ALLE TEILE, DIE AN UNS ZURÜCKGESANDT WERDEN, MÜSSEN SACHGEMÄSS VERPACKT SEIN, d. h. in dem entsprechenden Einzelkarton und einem zweiten Karton mit entsprechendem Verpackungsmaterial. Dies betrifft jeglichen Transportweg!

BITTE BEACHTEN: Teile, die nicht sachgemäß verpackt werden und uns aus diesem Grunde defekt erreichen, sind von der Katun-Qualitätsgarantie ausgeschlossen und werden nicht angenommen.

Schicken Sie Ihre Reklamation zur technischen Bewertung (frachtfrei) an die für diese Zwecke im Katun-Online-Katalog und dem gültigen regulären Katalog unter den „allgemeinen Hinweisen“ angegebene Adresse. Katun übernimmt keinerlei Verantwortung für Reklamationen, die an eine andere Adresse als die oben genannte geschickt werden. **Schicken Sie Reklamation zum Ersatz ohne Bewertung an Ihren Katun-Ansprechpartner.**

